

Gable Detail Styles

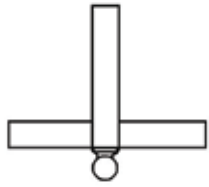

D - 1
(iT-b)

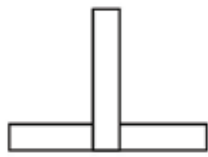

D - 2
(iT)

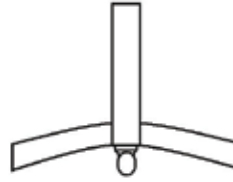

D - 3
(iTa-b)

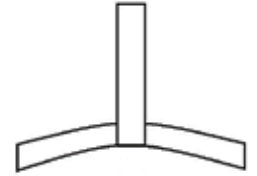

D - 4
(iTa)

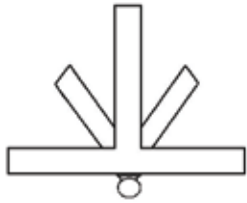

D - 5
(iTv-b)

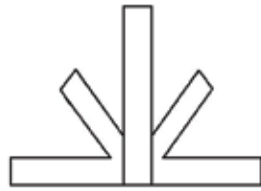

D - 6
(iTv)

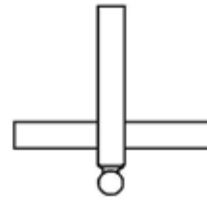

D - 7
(iC-b)

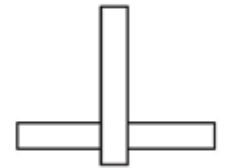

D - 8
(iC)

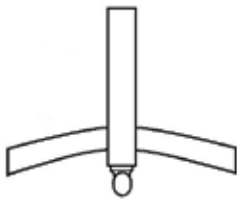

D - 9
(iCa-b)

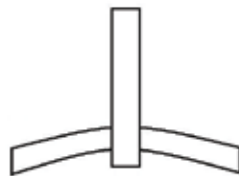

D - 10
(iCa)

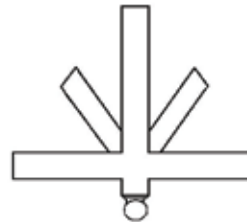

D - 11
(iCv-b)

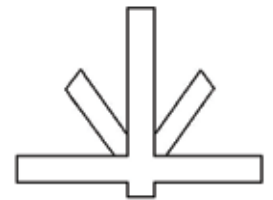

D - 12
(iCv)

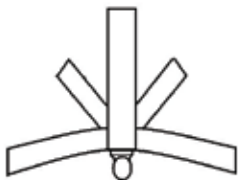

D - 13
(iTVa-b)

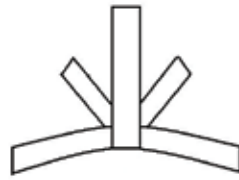

D - 14
(iTVa)

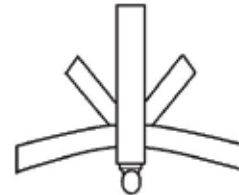

D - 15
(iCVa-b)

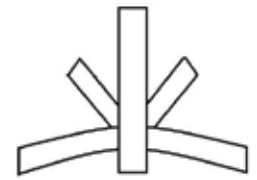

D - 16
(iCVa)

Each style is available in both G1 & G3 details.*

*See specifications sheet for G1 & G3 details. (Page 24)

For custom orders, please contact your local contractors desk or visit us at www.prestigediy.com to request quote.

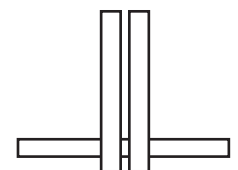

D - 48
(iCd)

Client Name
Dealer Name
Client Phone
Date

Post Width (U)
Stretcher Width (S)
Roof Pitch (P)
Gable Width (W)

G1 (1" Thick Post)

D-1	D-5	D-9	D-13
D-2	D-6	D-10	D-14
D-3	D-7	D-11	D-15
D-4	D-8	D-12	D-16

G3 (2.5" Thick Post)

D-1	D-5	D-9	D-13
D-2	D-6	D-10	D-14
D-3	D-7	D-11	D-15
D-4	D-8	D-12	D-16

Your gable selection is:

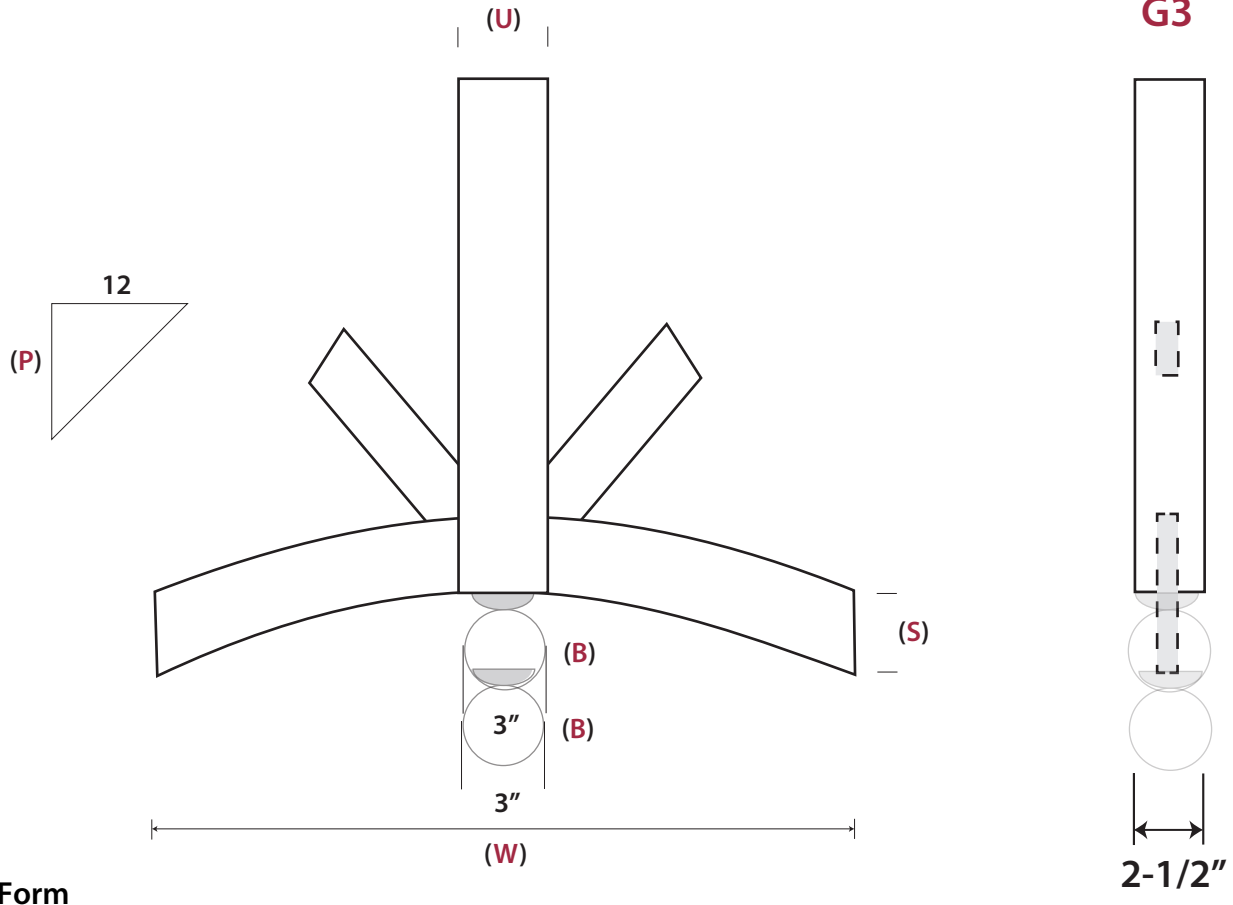

Clear Form

Approval

Download and open form on your local computer for full functionality.