



2017 PRICE BOOK

Prestige DIY Products are perhaps the finest PVC systems available for your home.

Constructed from premium quality PVC, these products have been beautifully designed and are *engineered to last*.

Prestige DIY Products™ offer the *elegant beauty* of traditional wood features, while being *virtually maintenance-free*. With the Prestige Advantage, you can expect to enjoy your product for as long as you own your home.

The Prestige Products™
Advantage

Beautiful

- Classic Architectural Look
- No Visible Fasteners
- Wide Assortment of Styles

Easy Installation

- Complete Kit, with Fasteners & Adhesive
- No Special Tools Needed
- Easy Innovative SmartLock™ Corners
- Flat-Pack for Safe & Easy Transportation

Virtually Maintenance Free

- Free-Foam Cellular PVC Construction
- Weather, Decay and Insect Resistant
- Paint Friendly with Acrylic Latex Paints



www.prestigediy.com



PRESTIGE DIY PRODUCTS PRICES - 2017



**P R E M I U M
C O L U M N
S T Y L E S**

S
Q
U
A
R
E

- [PLAIN COLUMNS](#)
- [RAISED PANEL COLUMNS](#)
- [FLUTED PANEL COLUMNS](#)
- [RECESSED SQUARE EDGE COLUMNS](#)
- [RECESSED FLUSH TRIM COLUMNS](#)
- [RECESSED RAISED TRIM COLUMNS](#)
- [CAP & BASE OPTIONS](#)
- [CONFIRMATION DRAWING](#)

[FLEX COLUMNS](#)

T
A
P
E
R
E
D

- [PLAIN COLUMNS](#)
- [RAISED PANEL COLUMNS](#)
- [RECESSED SQUARE EDGE COLUMNS](#)
- [RECESSED FLUSH TRIM COLUMNS](#)
- [CAP & BASE OPTIONS](#)
- [CONFIRMATION DRAWING](#)

P
R
E
M
I
U
M

- [UNIQUE FLARE](#)
- [COCHREN FLARE \(12" SINGLE LATTICE\)](#)
- [COCHREN FLARE \(16" SINGLE LATTICE\)](#)
- [COCHREN FLARE \(24" SINGLE LATTICE\)](#)
- [COCHREN FLARE \(12" DOUBLE LATTICE\)](#)
- [COCHREN FLARE \(16" DOUBLE LATTICE\)](#)
- [COCHREN FLARE \(24" DOUBLE LATTICE\)](#)
- [PREMIUM PREVIEW](#)
- [PREMIUM STYLES](#)



G
A
B
L
E
S

- [STANDARD GABLE PRICE PAGE](#)
- [GABLE BUILDER / COMING SOON](#)
- [GINGERBREADS](#)



L
O
U
V
R
E
S

- [CLOSED LOUVRE PREVIEW](#)
- [CLOSED LOUVRE](#)



S
H
U
T
T
E
R
S

- [DECOR COLLECTION SHUTTERS](#)
- [DISTINCTIVE COLLECTION SHUTTERS](#)
- [FLEX SHUTTERS](#)
- [SHUTTER HARDWARE](#)
- [SHUTTER POLICY](#)
- [SHUTTER BROCHURE](#)



N
E
W
A
L
S

- [PRESTIGE NEWAL POSTS](#)
- [PRESTIGE PLINTH BOXES](#)



S
O
F
F
I
T

- [PRESTIGE SOFFIT](#)



B
R
A
C
K
E
T
S

- [PRESTIGE BRACKETS](#)



P
L
A
N
T
E
R
S

- [PRESTIGE PLANTERS](#)



C
O
R
N
I
C
E

- [PRESTIGE CORNICE](#)



L
I
N
K
S

- [PRESTIGE COLUMNS INSTALLATION](#)
- [PRESTIGE GABLES ASSEMBLY](#)
- [PRESTIGE GABLES INSTALLATION](#)
- [PAINT OPTIONS](#)
- [PAINT SPECS](#)
- [PRESTIGE WARRANTY](#)





LIMITED WARRANTY - PRESTIGE DIY PRODUCTS™

1357042 Ontario Limited (hereinafter "Décor Innovations") warrants to the original consumer purchaser (the "Original Consumer Purchaser") and only to the extent set forth below, its successor and assign (together with the Original Consumer Purchaser, the "Consumer Purchaser"), subject to the terms and conditions herein, that each PRESTIGE DIY PRODUCTS™ Product, as shipped, will be free from manufacturing defects that cause the Product to delaminate, decay, rot, corrode or swell excessively from moisture for a period of thirty (30) years from the date of the original purchase from an authorized PRESTIGE DIY PRODUCTS™ dealer (the "Original Purchase Date"). Each Consumer Purchaser of PRESTIGE DIY PRODUCTS™ shall have sole responsibility for making determinations as to the suitability, effectiveness, and safety of any particular use or application of the PRESTIGE DIY PRODUCTS™. As building code regulations may vary from area to area, each Consumer Purchaser should consult local building and safety codes for specific requirements.

Value added paint options come with a 1 year limited warranty.

ADDITIONAL CONDITIONS AND EXCEPTIONS

In all events, Décor Innovation's sole and exclusive liabilities under this warranty are limited solely and exclusively to replacement of defective PRESTIGE DIY PRODUCTS™, or the issuance of a refund equal to the original cost of the PRESTIGE DIY PRODUCTS™. Under no circumstances shall Décor Innovations be liable for labour, installation, reinstallation, freight, taxes or any other charge related to defective PRESTIGE DIY PRODUCTS™. Décor Innovations shall not be liable under any circumstances for any indirect, incidental, punitive, consequential, exemplary or other damages of any kind whatsoever, whether any such claim is based upon theories of contract, warranty, negligence, tort strict liability or otherwise. This warranty does not provide protection against any failure of, defect in or damage to PRESTIGE DIY PRODUCTS™ caused by situations beyond normal exposure conditions, including but not limited to the following: intentional or unintentional misuse, abuse, neglect, or improper handling or storage; impact of foreign objects; earthquake, lightning, ice, fire, tornado, windstorm, flood, among others or any other acts of God; improper installation of the PRESTIGE DIY PRODUCTS™ or its structural supports, or installation not in strict adherence to Décor Innovation's written instructions; cracking, distortion, movement, settlement, or warping of the PRESTIGE DIY PRODUCTS™ structural supports or accessories used in connection therewith; insurrection, terrorism, acts of war, riot, vandalism, improper maintenance, use of incompatible accessories; or other products that cause a PRESTIGE DIY PRODUCTS™ defect or failure to occur; pollution, acid rain, contact with harmful chemicals or vapors; or ordinary and expected weathering due to exposure to the elements; which for purposes of this Warranty is defined to be fading, chalking or darkening of the surface of the Product due to exposure to natural sunlight and extreme atmospheric conditions that are unique to and may vary depending on geographic location. Décor Innovations shall have sole discretion to determine, based on reasonable criteria, whether the PRESTIGE DIY PRODUCTS™ is suffering from normal weathering. This Warranty does not cover painted finishes or coating applied to PRESTIGE DIY PRODUCTS™ by the Consumer Purchaser or any third party. Failure to adhere to Décor Innovation's recommended guidelines for application of painted surfaces shall void this Warranty. All claims under this Limited Warranty must be made within 90 days from the time that the defect is discovered and while the PRESTIGE DIY PRODUCTS™ is in place. Consumer Purchaser shall provide Décor Innovations and its agents and employees with a reasonable opportunity to inspect and test the PRESTIGE DIY PRODUCTS™, its installation, and the environment in which the Consumer Purchaser used it prior to removal so that Décor Innovations may determine what replacement, if any, may be needed. In the event that Décor Innovations determines that a replacement is appropriate, Décor Innovations shall have the option of retaining all material that is replaced. If Décor Innovations replaces any material under this warranty, it may substitute products designed by Décor Innovations to be of compatible quality or price range in the event that the product initially purchased has been discontinued or modified. Anything less than strict compliance with these notice and inspection provisions shall serve to void all warranties with regard to PRESTIGE DIY PRODUCTS™. This Warranty may not be altered or amended except in a written statement signed Décor Innovations and Consumer Purchaser. Décor Innovations has not authorized any dealer or other person to make statements or representations regarding the performance of PRESTIGE DIY PRODUCTS™ except as contained in this Warranty, and Décor Innovations shall not be bound by any such statements other than those contained herein.

THE FOREGOING WARRANTY IS EXCLUSIVE AND IN LIEU OF ANY AND ALL OTHER APPLICABLE WARRANTIES, EXPRESS OR IMPLIED, INCLUDING WITHOUT LIMITATION, ANY IMPLIED WARRANTY OF MERCHANTABILITY OR FITNESS FOR A PARTICULAR USE.



















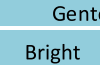





This Warranty is transferable to a successor by the Original Consumer Purchaser with the transfer of other conveyance of the PRESTIGE DIY PRODUCTS™ and shall not be transferable or assignable by any subsequent consumer purchaser. In accordance with the foregoing, this Warranty shall expire upon the first to occur of: (i) the transfer or other conveyance of the PRESTIGE DIY PRODUCTS™ by the Original Consumer Purchaser's successor or assign; or (ii) thirty (30) years from the Original Purchase Date.

Some states and provinces do not permit limitations on the duration of implied warranties or exclusions or limitations of incidental or consequential damages, so certain limitations set forth in this Limited Warranty may not apply to you. This warranty gives you specific legal rights, and you may have other rights which may vary from state to state.

FILING A WARRANTY CLAIM

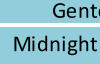
To file a claim under this Warranty, Consumer Purchaser must send proof of purchase, a photograph of the defective PRESTIGE DIY PRODUCTS™ and a written description of the nature of the defect to the company's corporate address in Oakville, ON. (See address below). Décor Innovations reserves the right to investigate any claim hereunder. Upon verification of the claim, Décor Innovations shall, at its sole discretion, either arrange for the delivery of replacement Product or issue a refund equal to the original cost of the Product only. In either instance, Consumer Purchaser shall allow Décor Innovations at least ninety (90) days for investigation and either replacement or refund.

Stock Colours

		EURO FINISH					
LIGHT COLOURS (LRV 56 - 100)	Benjamin Moore Colours						
	Tan AF-80	Mascarpone AF-20	White 2131-70	CornSilk CC-218	Sandalwood 273	Horizon OC-53	
							
	Gentek Colours						
	Almond (532)	Sandstone (540)	Bright White (431)	Maize (502)	Sandalwood (508)	Pearl (534)	
							
DARK COLOURS (LRV 0 - 55)	Benjamin Moore Colours						
	Clay AF-155	Commercial Brown 2139-10	Black 2127-10	Blue HC-159	High Park 467	Escarpment CC-518	
							
	Gentek Colours						
	Pebble (559)	Commercial Brown (562)	Midnight Surf (509)	Wedgewood Blue (535)	Sable (547)	Storm (570)	
							

* **Custom Colours & Stains**
Custom surcharge will apply
Speak with your PrestigeDIY
Representative for more information.

Stock Paint: 30% Surcharge on
Material Value

Dark Colours
* Dark Colour Paints have
heat reflective qualities.

Standard **EURO FINISH** on all
dark painted products.

Stock Stains



Cherry
DD#9571



Teak
DD#9512



Espresso
DD#9575



Mahogany
DD#9509

**Stain Finishes on
Prestige DIY Products!**

Stock Stain: 45% Surcharge on
Material Value with Top Clear Coat



Espresso Stain

Note: Colours may vary from above chart. All colours to be signed off on before production.

5 Year Limited Paint Warranty.

For further information please visit us at prestigediy.com

Preparation & Application

Your Prestige DIY Products™ are manufactured using premium free-foam cellular PVC and do not require painting to validate the warranty. If painting is preferred, please use the guidelines below.

Surface Preparation

Prestige DIY Products™ can be painted to achieve the desired look or accent colour of your home. To ensure good paint adhesion, the surface of the pvc product should be clean, dry, and free of dirt, mildew, chalk, grease and any other surface contaminants before paint application. Prior to cleaning it is a good practice to fill any holes and remove any marks or blemishes that may appear during the installation process with an exterior filler, (for example, sandable Bondo).

Cleaning can be accomplished using a cloth and a mixture of mild detergent and water. Other cleaning agents include a mild household spray cleaner, a degreaser, or alcohol.

Coating Specification

A 100% acrylic latex or 100% acrylic latex with a urethane additive should be used to achieve superior coating durability and flexibility. Only light to medium coloured paints with a light reflective value (LRV) of 55 units or greater should be applied to Prestige DIY Products™. *Using a paint with a LRV below 55 units will void our product warranty.*

Paint manufacturer recommendations include priming with an exterior 100% acrylic latex primer, followed by two coats of exterior 100% acrylic latex satin finish paint.

Application

Apply paint when the air and surface temperatures are 2°C (35°F) or above, and when the air and surface temperatures will remain above this temperature for the next 24 hours. Avoid painting early in the morning or late in the day when dew and condensation are likely to form, or when rain or snow is threatening. To prolong the shelf life of the paint, always protect it from freezing.

Apply primer and topcoats using the following methods:

- Brush: Use a nylon/polyester brush.
- Roller: Use a 3/8" – 3/4" nap synthetic roller.
- Spray: Airless Pressure...2000 psi Tip...015"-019"

Typical Drying Times (Dry Time at 25°C (77°F); 50% Relative Humidity):

- To the Touch: 30 minutes - To Recoat: 4 hours
- To Handle: 1 hour - To Full Cure: 30 days

Considerations

- Higher quality paints typically outperform lower quality paints.
- Temperature, humidity, wind, and the amount of direct sunlight at time of application will affect paint drying times.
- Prestige Products™ are impermeable to moisture; it may take as long as 45 days for paint application to fully cure.
- Paint failures on wood are due primarily to moisture cycling. Since Prestige Products™ cannot absorb moisture, paints will adhere better and for a much longer time when applied to premium PVC versus wood.



CUSTOM STRAIGHT COLUMN LAYOUT

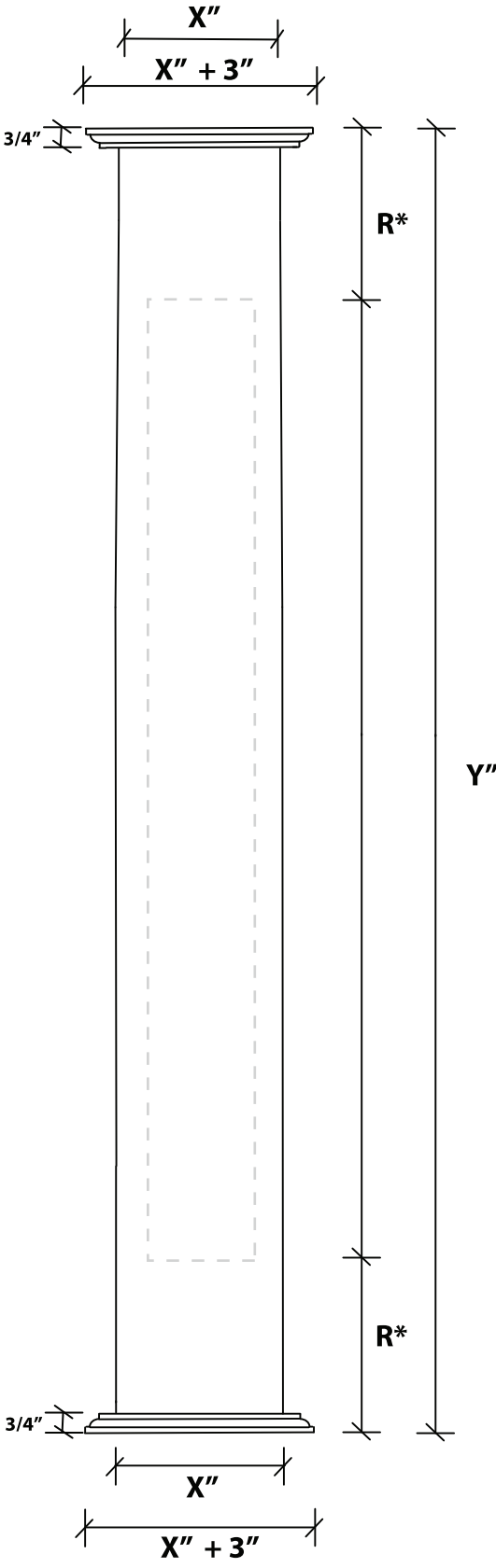

CLIENT INFORMATION

Dealer Name: _____

Project: _____

PO#: _____

Project Contact: _____

Date: _____

Approved By: _____

PANEL SIZES

1. Height (Y'') _____

2. Width (X'') _____

• Nominal

• Actual

3. Inside Dims _____

4. Painted No

Yes

Colour: _____

REVEALS

R^* Top and Bottom Panel Reveals

- 10" for columns 10' or less
- 15" for columns 11' or greater

PANEL PROFILE

1. Plain	<input type="checkbox"/>
2. Fluted	<input type="checkbox"/>
3. Raised	<input type="checkbox"/>
4. Recessed	<input type="checkbox"/>
↳ Square Edge	<input type="checkbox"/>
↳ Round Edge	<input type="checkbox"/>
↳ w/ Base Cap Trim	<input type="checkbox"/>
↳ Flush Trim	<input type="checkbox"/>
↳ Raised Trim	<input type="checkbox"/>

1. Single Panel

2. Double Panel

3. 1/3 - 2/3 Panel

4. Custom _____

NOTES: _____

Panel Locks: M F

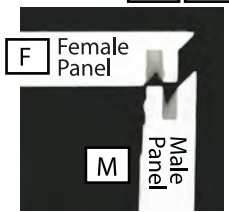

CAPS & BASES

Place a 'T' for Column Top
Place 'B' for Column Bottom

Craftsman



4" _____

6" _____

8" _____

10" _____

Chamfered



4" _____

6" _____

8" _____

10" _____

Crown Mould



4" _____

5" _____

6" _____

Base Cap Edge



4" _____

6" _____

8" _____

10" _____

Tuscan



5" _____

6" _____

8" _____

10" _____

Solid Crown



1. _____

2. _____

Prestige Column Sizes & Reveals - Straight Columns

Product Code	Prestige PVC Square Columns	Outside Dims. (inches)	Inside Dims. (inches)	Column Weight (lbs)
CPSPL-0808-096	Prestige Column - PVC, Square, Plain Panel, 8" x 8" x 8'	8" (7 1/4")	6 1/4"	40
CPSPL-0808-120	Prestige Column - PVC, Square, Plain Panel, 8" x 8" x 10'	8" (7 1/4")	6 1/4"	49
CPSPL-1010-096	Prestige Column - PVC, Square, Plain Panel, 10" x 10" x 8'	10" (9 3/8")	8 3/8"	49
CPSFL-0808-096	Prestige Column - PVC, Square, Fluted Panel, 8" x 8" x 8'	8" (7 1/4")	6 1/4"	40
CPSFL-0808-120	Prestige Column - PVC, Square, Fluted Panel, 8" x 8" x 10'	8" (7 1/4")	6 1/4"	49
CPSFL-1010-096	Prestige Column - PVC, Square, Fluted Panel, 10" x 10" x 8'	10" (9 3/8")	8 3/8"	49
CPSRA-0808-096	Prestige Column - PVC, Square, Raised Panel, 8" x 8" x 8'	8" (7 1/4")	6 1/4"	40
CPSRA-0808-120	Prestige Column - PVC, Square, Raised Panel, 8" x 8" x 10'	8" (7 1/4")	6 1/4"	49
CPSRA-1010-096	Prestige Column - PVC, Square, Raised Panel, 10" x 10" x 8'	10" (9 3/8")	8 3/8"	49
* CPSRS-0808-096	Prestige Column - PVC, Square, Recessed Panel - Square Edge, 8" x 8" x 8'	8" (7 1/4")	5-1/4"	40
* CPSRS-0808-120	Prestige Column - PVC, Square, Recessed Panel - Square Edge, 8" x 8" x 10'	8" (7 1/4")	5-1/4"	49
CPSRS-1010-096	Prestige Column - PVC, Square, Recessed Panel - Square Edge, 10" x 10" x 8'	10" (9 3/8")	7-3/8"	49
* CPSRB-0808-096	Prestige Column - PVC, Square, Recessed Panel Flush Trim - Base Cap Edge, 8" x 8" x 8'	8" (7 1/4")	5-1/4"	41
* CPSRB-0808-120	Prestige Column - PVC, Square, Recessed Panel Flush Trim - Base Cap Edge, 8" x 8" x 10'	8" (7 1/4")	5-1/4"	52
CPSRB-1010-096	Prestige Column - PVC, Square, Recessed Panel Flush Trim - Base Cap Edge, 10" x 10" x 8'	10" (9 3/8")	7-3/8"	52
* CPSRB-0808-096	Prestige Column - PVC, Square, Recessed Panel Raised Trim - Base Cap Edge, 8" x 8" x 8'	8" (7 1/4")	5-1/4"	41
* CPSRB-0808-120	Prestige Column - PVC, Square, Recessed Panel Raised Trim - Base Cap Edge, 8" x 8" x 10'	8" (7 1/4")	5-1/4"	52
CPSRB-1010-096	Prestige Column - PVC, Square, Recessed Panel Raised Trim - Base Cap Edge, 10" x 10" x 8'	10" (9 3/8")	7-3/8"	52

NOTE: * Will Not Fit Around 6" x 6" PT Wood Structure.

Packaging- Standard Kit consists of boxed, 4 column panels, cap/base with adhesive strip, squaring corners, 2 oz. adhesive, fasteners, instructions.

Prestige Panel Styles

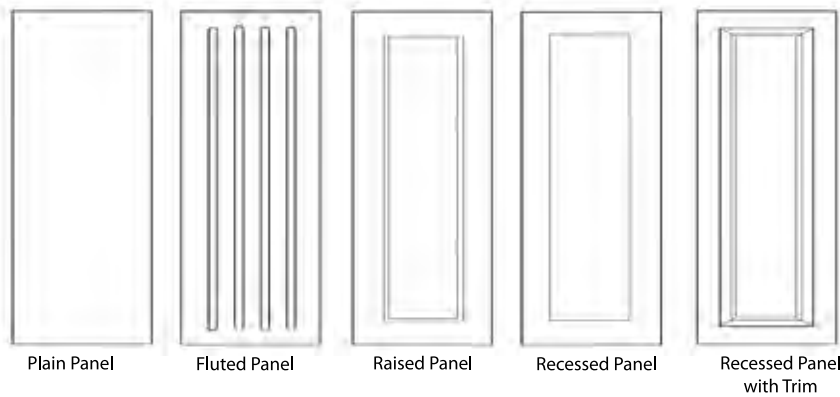

	Column Width (")	Outside Dims (")	Inside Dims (")		
			Plain, Fluted, Raised	Recessed Sq. Edge *	Recessed Base Cap *
1/2" Wall	6	5-1/2"	4-1/2"	3-1/2"	N/A
	8	7-1/4"	6-1/4"	5-1/4"	5-1/4"
	10	9-3/8"	8-3/8"	7-3/8"	7-3/8"
	12	11-1/4"	10"	9"	9"
5/8" Wall	14	13-1/4"	12"	11"	11"
	16	15-1/4"	14"	13"	13"
	18	17-1/4"	16"	15"	15"
	20	19-1/4"	18"	17"	17"
	22	21-1/4"	20"	19"	19"
	24	23-1/4"	22"	21"	21"

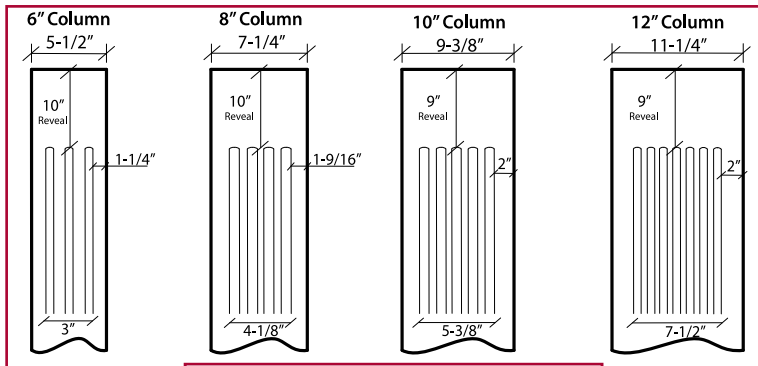

Reveals for Columns Under 10'

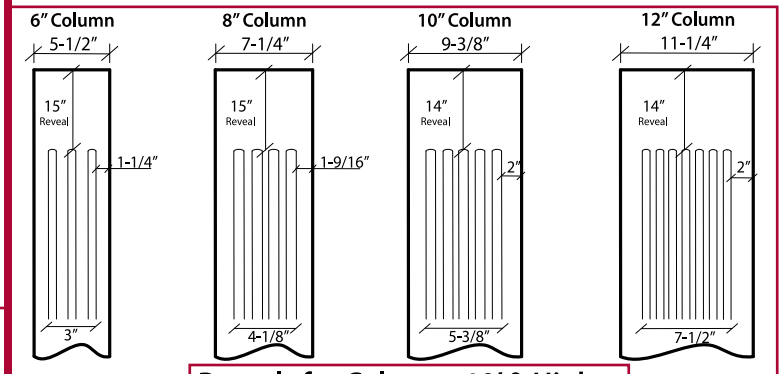

Reveals for Columns 10' & Higher

* NOTE:

- For any column skirts above 6" in height, the column reveals will go to 14".
- 6" – 10" columns with square edge recessed panels will use either a 3/8" or a 1/2" thick backer panel.
- 12" columns and larger, with square edge recessed panels, will use a 1/2" thick backer panel.
- All columns with recessed panel with base cap trim will use a 5/8" thick column shaft and backer panel.

PRESTIGE FLEX COLUMNS - 2017

FLEX COLUMNS

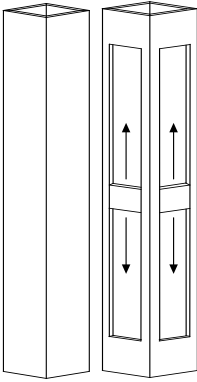

ADJUSTABLE 4" DIVIDER

*Reveals match Standard Column Layouts

6" SQUARE COLUMNS	PRODUCT CODE	DESCRIPTION	FLEX PACKAGE (1PC)	FLEX PACKAGE (6PCS)	FLEX PACKAGE (24PCS)
	CPSPL-06096-FX	Column - PVC, Square, Plain, 6" @ 8'	\$ 149.77	\$ 140.96	\$ 132.15
	CPSPL-06120-FX	Column - PVC, Square, Plain, 6" @ 10'	\$ 165.57	\$ 155.83	\$ 146.09
	CSP-6FX	Skirt - PVC, Flex Skirt, 1" x 6"ID (1 Set - 4 L's)	\$ 9.56	\$ 9.00	\$ 8.44
8" SQUARE COLUMNS					
	CPSPL-08096-FX	Column - PVC, Square, Plain, 8" @ 8'	\$ 144.00	\$ 135.53	\$ 127.06
	CPSPL-08120-FX	Column - PVC, Square, Plain, 8" @ 10'	\$ 164.07	\$ 154.42	\$ 144.77
	CSP-8FX	Skirt - PVC, Flex Skirt, 1" x 8"ID (1 Set - 4 L's)	\$ 9.07	\$ 8.54	\$ 8.00
10" SQUARE COLUMNS					
	CPSPL-10096-FX	Column - PVC, Square, Plain, 10" @ 8'	\$ 164.75	\$ 155.06	\$ 145.37
	CPSPL-10120-FX	Column - PVC, Square, Plain, 10" @ 10'	\$ 189.84	\$ 178.68	\$ 167.51
	CSP-10FX	Skirt - PVC, Flex Skirt, 1" x 10"ID (1 Set - 4 L's)	\$ 12.20	\$ 11.48	\$ 10.76
8" RECESSED SQUARE EDGE					
	CPSRS-08096-FX	Column - PVC, Square, Recessed Square Edge Panel, 8" @ 8'	\$ 191.39	\$ 180.14	\$ 168.88
	CPSRS-08120-FX	Column - PVC, Square, Recessed Square Edge Panel, 8" @ 10'	\$ 221.57	\$ 208.54	\$ 195.50
	CSP-8FX	Skirt - PVC, Flex Skirt, 1" x 8"ID (1 Set - 4 L's)	\$ 10.88	\$ 10.24	\$ 9.60
10" RECESSED SQUARE EDGE					
	CPSRS-10096-FX	Column - PVC, Square, Recessed Square Edge Panel, 10" @ 8'	\$ 225.75	\$ 212.47	\$ 199.19
	CPSRS-10120-FX	Column - PVC, Square, Recessed Square Edge Panel, 10" @ 10'	\$ 265.24	\$ 249.64	\$ 234.04
	CSP-10FX	Skirt - PVC, Flex Skirt, 1" x 10"ID (1 Set - 4 L's)	\$ 12.20	\$ 11.48	\$ 10.76

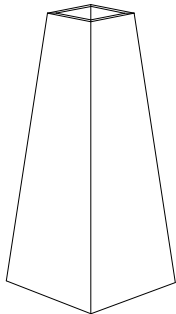

12"-8" PLAIN TAPERED	PRODUCT CODE	DESCRIPTION	1 PC	6 PCS	24 PCS
	CPTPL-1208048-FX	Column - PVC, Tapered, Plain Panel, 12"-8" @ 4'	\$ 120.08	\$ 113.01	\$ 105.95
	CPTPL-1208060-FX	Column - PVC, Tapered, Plain Panel, 12"-8" @ 5'	\$ 132.15	\$ 124.37	\$ 116.60
	CPTPL-1208072-FX	Column - PVC, Tapered, Plain Panel, 12"-8" @ 6'	\$ 144.22	\$ 135.74	\$ 127.26
	CPTPL-1208096-FX	Column - PVC, Tapered, Plain Panel, 12"-8" @ 8'	\$ 168.37	\$ 158.47	\$ 148.56
	CPTPL-1208120-FX	Column - PVC, Tapered, Plain Panel, 12"-8" @ 10'	\$ 192.52	\$ 181.20	\$ 169.87
	CPTPL-1208144-FX	Column - PVC, Tapered, Plain Panel, 12"-8" @ 12'	\$ 216.73	\$ 203.99	\$ 191.24
	CSP-1208FX	Skirt - PVC, Flex Skirt, 2 L's @ 1" x 12"ID & 2 L's @ 1" x 8"ID(1 Set)	\$ 12.20	\$ 11.48	\$ 10.76

ADHESIVE

ADHS-WO7052

Weld On705 WHITE 2 OZ Tube

1 PC	6 PCS	24 PCS
\$ 1.63	\$ 13.03	\$ 39.09

1"H x 1 1/2"W SQUARING SKIRT

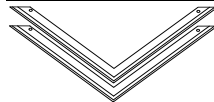

*Adds 3" to Outside Dims

SQUARE DIMS			TAPERED DIMS		
SIZE	OUTSIDE	INSIDE	SIZE	OUTSIDE	INSIDE
6"	5-1/2"	4-1/2"	12"-8"	12"	8"
8"	7-1/4"	6-1/4"			
10"	9-3/8"	8-3/8"			
SQUARE RECESSED PANEL DIMS					
SIZE	OUTSIDE	INSIDE			
8"	7-1/4"	5-1/4"			
10"	9-3/8"	7-3/8"			

****PRICES REFLECT 2 PC SHAFT, PACKAGED IN CLEAR PLASTIC FILM /W EDGE PROTECTORS & BAGGED**
SOLD SEPARATELY: Adhesive, Fasteners & Squaring Skirt Sold in 1-6-24 Packs
Square Column Recessed Panel /w 4" Adjustable Divider Set (Micro-Beveled Edges for alignment to Column Shaft)
***PRICES SUBJECT TO CHANGE WITHOUT NOTICE**



PRICE LEVEL	
STOCKING	
Standard C&B: 4" Craftsman	
CAP	4" Craftsman Skirt
BASE	4" Craftsman Skirt
<input checked="" type="checkbox"/> ADD CAP & BASE	

PRESTIGE COLUMNS - 2017

6" COLUMNS	PRODUCT CODE / SHAFT	PRODUCT CODE /w	DESCRIPTION	1 PIECE	6 PIECE
	ONLY	4" SKIRTS			
	CPSPL-06048	CPSPL-06048-4K	Column - PVC, Square, Plain, 6" @ 4'	\$ 146.84	\$ 138.03
	CPSPL-06060	CPSPL-06060-4K	Column - PVC, Square, Plain, 6" @ 5'	\$ 155.52	\$ 146.19
	CPSPL-06072	CPSPL-06072-4K	Column - PVC, Square, Plain, 6" @ 6'	\$ 164.21	\$ 154.36
	CPSPL-06096	CPSPL-06096-4K	Column - PVC, Square, Plain, 6" @ 8'	\$ 181.62	\$ 170.72
	CPSPL-06108	CPSPL-06108-4K	Column - PVC, Square, Plain, 6" @ 9'	\$ 190.31	\$ 178.89
	CPSPL-06120	CPSPL-06120-4K	Column - PVC, Square, Plain, 6" @ 10'	\$ 199.02	\$ 187.08
	CPSPL-06144	CPSPL-06144-4K	Column - PVC, Square, Plain, 6" @ 12'	\$ 216.45	\$ 203.47
8" COLUMNS					
	CPSPL-08048	CPSPL-08048-4K	Column - PVC, Square, Plain, 8" @ 4'	\$ 157.06	\$ 147.64
	CPSPL-08060	CPSPL-08060-4K	Column - PVC, Square, Plain, 8" @ 5'	\$ 170.33	\$ 160.11
	CPSPL-08072	CPSPL-08072-4K	Column - PVC, Square, Plain, 8" @ 6'	\$ 183.60	\$ 172.58
	CPSPL-08096	CPSPL-08096-4K	Column - PVC, Square, Plain, 8" @ 8'	\$ 210.13	\$ 197.52
	CPSPL-08108	CPSPL-08108-4K	Column - PVC, Square, Plain, 8" @ 9'	\$ 223.40	\$ 209.99
	CPSPL-08120	CPSPL-08120-4K	Column - PVC, Square, Plain, 8" @ 10'	\$ 236.66	\$ 222.46
	CPSPL-08144	CPSPL-08144-4K	Column - PVC, Square, Plain, 8" @ 12'	\$ 263.26	\$ 247.47
10" COLUMNS					
	CPSPL-10048	CPSPL-10048-4K	Column - PVC, Square, Plain, 10" @ 4'	\$ 173.45	\$ 163.05
	CPSPL-10060	CPSPL-10060-4K	Column - PVC, Square, Plain, 10" @ 5'	\$ 190.04	\$ 178.63
	CPSPL-10072	CPSPL-10072-4K	Column - PVC, Square, Plain, 10" @ 6'	\$ 206.62	\$ 194.23
	CPSPL-10096	CPSPL-10096-4K	Column - PVC, Square, Plain, 10" @ 8'	\$ 239.79	\$ 225.40
	CPSPL-10108	CPSPL-10108-4K	Column - PVC, Square, Plain, 10" @ 9'	\$ 256.37	\$ 240.99
	CPSPL-10120	CPSPL-10120-4K	Column - PVC, Square, Plain, 10" @ 10'	\$ 272.95	\$ 256.57
	CPSPL-10144	CPSPL-10144-4K	Column - PVC, Square, Plain, 10" @ 12'	\$ 306.20	\$ 287.83
12" COLUMNS					
	CPSPL-12048	CPSPL-12048-4K	Column - PVC, Square, Plain, 12" @ 4'	\$ 189.84	\$ 178.45
	CPSPL-12060	CPSPL-12060-4K	Column - PVC, Square, Plain, 12" @ 5'	\$ 209.74	\$ 197.16
	CPSPL-12072	CPSPL-12072-4K	Column - PVC, Square, Plain, 12" @ 6'	\$ 229.64	\$ 215.86
	CPSPL-12096	CPSPL-12096-4K	Column - PVC, Square, Plain, 12" @ 8'	\$ 269.44	\$ 253.27
	CPSPL-12108	CPSPL-12108-4K	Column - PVC, Square, Plain, 12" @ 9'	\$ 289.33	\$ 271.97
	CPSPL-12120	CPSPL-12120-4K	Column - PVC, Square, Plain, 12" @ 10'	\$ 309.23	\$ 290.68
	CPSPL-12144	CPSPL-12144-4K	Column - PVC, Square, Plain, 12" @ 12'	\$ 349.13	\$ 328.19
14" COLUMNS					
	CPSPL-14048	CPSPL-14048-4K	Column - PVC, Square, Plain, 14" @ 4'	\$ 203.19	\$ 191.00
	CPSPL-14060	CPSPL-14060-4K	Column - PVC, Square, Plain, 14" @ 5'	\$ 226.41	\$ 212.83
	CPSPL-14072	CPSPL-14072-4K	Column - PVC, Square, Plain, 14" @ 6'	\$ 249.62	\$ 234.65
	CPSPL-14096	CPSPL-14096-4K	Column - PVC, Square, Plain, 14" @ 8'	\$ 296.06	\$ 278.30
	CPSPL-14108	CPSPL-14108-4K	Column - PVC, Square, Plain, 14" @ 9'	\$ 319.27	\$ 300.11
	CPSPL-14120	CPSPL-14120-4K	Column - PVC, Square, Plain, 14" @ 10'	\$ 342.49	\$ 321.94
	CPSPL-14144	CPSPL-14144-4K	Column - PVC, Square, Plain, 14" @ 12'	\$ 389.04	\$ 365.70

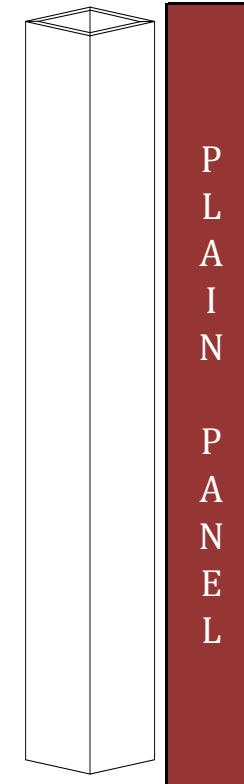

DIMS		
SIZE	OUTSIDE	INSIDE
6"	5-1/2"	4-1/2"
8"	7-1/4"	6-1/4"
10"	9-3/8"	8-3/8"
12"	11-1/2"	10-1/2"
14"	13-1/4"	12-1/4"

SQUARING "L" INCLUDED

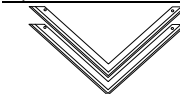

*Adds 3" to Outside Dims

***12% FOR CUSTOM HEIGHT & 12% FOR ACTUAL WIDTH
 ***FOR COLUMNS LARGER THAN 14" PLEASE CONTACT YOUR LOCAL PRESTIGE DEALER
 PRICES SUBJECT TO CHANGE WITHOUT NOTICE



PRICE LEVEL	
STOCKING	
Standard C&B: 4" Craftsman	
CAP	4" Craftsman Skirt
BASE	4" Craftsman Skirt
<input checked="" type="checkbox"/> ADD CAP & BASE	

PRESTIGE COLUMNS - 2017

6" COLUMNS

PRODUCT CODE / SHAFT ONLY	PRODUCT CODE /w 4" SKIRTS	DESCRIPTION	1 PIECE	6 PIECE
CPSRA-06048	CPSRA-06048-4K	Column - PVC, Square, Raised Panel, 6" @ 4'	\$ 168.09	\$ 158.00
CPSRA-06060	CPSRA-06060-4K	Column - PVC, Square, Raised Panel, 6" @ 5'	\$ 178.04	\$ 167.36
CPSRA-06072	CPSRA-06072-4K	Column - PVC, Square, Raised Panel, 6" @ 6'	\$ 187.99	\$ 176.71
CPSRA-06096	CPSRA-06096-4K	Column - PVC, Square, Raised Panel, 6" @ 8'	\$ 207.89	\$ 195.42
CPSRA-06108	CPSRA-06108-4K	Column - PVC, Square, Raised Panel, 6" @ 9'	\$ 217.84	\$ 204.77
CPSRA-06120	CPSRA-06120-4K	Column - PVC, Square, Raised Panel, 6" @ 10'	\$ 227.79	\$ 214.12
CPSRA-06144	CPSRA-06144-4K	Column - PVC, Square, Raised Panel, 6" @ 12'	\$ 247.74	\$ 232.88

8" COLUMNS

CPSRA-08048	CPSRA-08048-4K	Column - PVC, Square, Raised Panel, 8" @ 4'	\$ 185.41	\$ 174.29
CPSRA-08060	CPSRA-08060-4K	Column - PVC, Square, Raised Panel, 8" @ 5'	\$ 198.68	\$ 186.76
CPSRA-08072	CPSRA-08072-4K	Column - PVC, Square, Raised Panel, 8" @ 6'	\$ 211.94	\$ 199.23
CPSRA-08096	CPSRA-08096-4K	Column - PVC, Square, Raised Panel, 8" @ 8'	\$ 238.48	\$ 224.17
CPSRA-08108	CPSRA-08108-4K	Column - PVC, Square, Raised Panel, 8" @ 9'	\$ 251.74	\$ 236.64
CPSRA-08120	CPSRA-08120-4K	Column - PVC, Square, Raised Panel, 8" @ 10'	\$ 265.01	\$ 249.11
CPSRA-08144	CPSRA-08144-4K	Column - PVC, Square, Raised Panel, 8" @ 12'	\$ 291.61	\$ 274.11

10" COLUMNS

CPSRA-10048	CPSRA-10048-4K	Column - PVC, Square, Raised Panel, 10" @ 4'	\$ 201.80	\$ 189.69
CPSRA-10060	CPSRA-10060-4K	Column - PVC, Square, Raised Panel, 10" @ 5'	\$ 218.38	\$ 205.28
CPSRA-10072	CPSRA-10072-4K	Column - PVC, Square, Raised Panel, 10" @ 6'	\$ 234.97	\$ 220.87
CPSRA-10096	CPSRA-10096-4K	Column - PVC, Square, Raised Panel, 10" @ 8'	\$ 268.13	\$ 252.04
CPSRA-10108	CPSRA-10108-4K	Column - PVC, Square, Raised Panel, 10" @ 9'	\$ 284.71	\$ 267.63
CPSRA-10120	CPSRA-10120-4K	Column - PVC, Square, Raised Panel, 10" @ 10'	\$ 301.29	\$ 283.22
CPSRA-10144	CPSRA-10144-4K	Column - PVC, Square, Raised Panel, 10" @ 12'	\$ 334.55	\$ 314.48

12" COLUMNS

CPSRA-12048	CPSRA-12048-4K	Column - PVC, Square, Raised Panel, 12" @ 4'	\$ 218.18	\$ 205.09
CPSRA-12120	CPSRA-12060-4K	Column - PVC, Square, Raised Panel, 12" @ 5'	\$ 238.09	\$ 223.80
CPSRA-12072	CPSRA-12072-4K	Column - PVC, Square, Raised Panel, 12" @ 6'	\$ 257.98	\$ 242.50
CPSRA-12096	CPSRA-12096-4K	Column - PVC, Square, Raised Panel, 12" @ 8'	\$ 297.78	\$ 279.92
CPSRA-12108	CPSRA-12108-4K	Column - PVC, Square, Raised Panel, 12" @ 9'	\$ 317.68	\$ 298.62
CPSRA-12120	CPSRA-12120-4K	Column - PVC, Square, Raised Panel, 12" @ 10'	\$ 337.58	\$ 317.33
CPSRA-12144	CPSRA-12144-4K	Column - PVC, Square, Raised Panel, 12" @ 12'	\$ 377.48	\$ 354.83

14" COLUMNS

CPSRA-14048	CPSRA-14048-4K	Column - PVC, Square, Raised Panel, 14" @ 4'	\$ 243.12	\$ 228.53
CPSRA-14060	CPSRA-14060-4K	Column - PVC, Square, Raised Panel, 14" @ 5'	\$ 266.33	\$ 250.35
CPSRA-14072	CPSRA-14072-4K	Column - PVC, Square, Raised Panel, 14" @ 6'	\$ 289.54	\$ 272.17
CPSRA-14096	CPSRA-14096-4K	Column - PVC, Square, Raised Panel, 14" @ 8'	\$ 335.98	\$ 315.82
CPSRA-14108	CPSRA-14108-4K	Column - PVC, Square, Raised Panel, 14" @ 9'	\$ 359.19	\$ 337.64
CPSRA-14120	CPSRA-14120-4K	Column - PVC, Square, Raised Panel, 14" @ 10'	\$ 382.41	\$ 359.47
CPSRA-14144	CPSRA-14144-4K	Column - PVC, Square, Raised Panel, 14" @ 12'	\$ 428.96	\$ 403.22

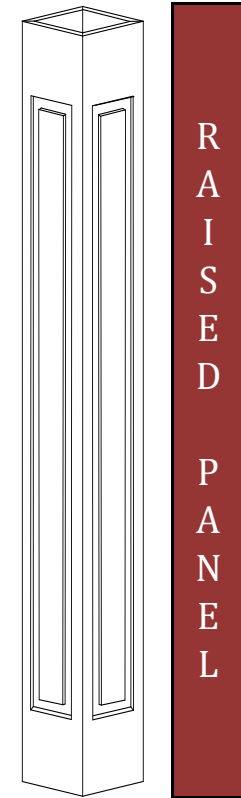

DIMS		
SIZE	OUTSIDE	INSIDE
6"	5-1/2"	4-1/2"
8"	7-1/4"	6-1/4"
10"	9-3/8"	8-3/8"
12"	11-1/2"	10-1/2"
14"	13-1/4"	12-1/4"

*12% FOR CUSTOM HEIGHT & 12% FOR ACTUAL WIDTH & 12% FOR DOUBLE PANEL
 ***FOR COLUMNS LARGER THAN 14" PLEASE CONTACT YOUR LOCAL PRESTIGE DEALER
 **PRICES SUBJECT TO CHANGE WITHOUT NOTICE

SQUARING "L" INCLUDED



*Adds 3" to Outside Dims



PRICE LEVEL	
STOCKING	
Standard C&B: 4" Craftsman	
CAP	4" Craftsman Skirt
BASE	4" Craftsman Skirt
<input checked="" type="checkbox"/> ADD CAP & BASE	

PRESTIGE COLUMNS - 2017

6" COLUMNS	PRODUCT CODE / SHAFT ONLY	PRODUCT CODE /w 4" SKIRTS	DESCRIPTION	1 PIECE	6 PIECE
	CPSFL-06048	CPSFL-06048-4K	Column - PVC, Square, Fluted Panel, 6" @ 4'	\$ 168.09	\$ 158.00
CPSFL-06060	CPSFL-06060-4K	Column - PVC, Square, Fluted Panel, 6" @ 5'	\$ 178.04	\$ 167.36	
CPSFL-06072	CPSFL-06072-4K	Column - PVC, Square, Fluted Panel, 6" @ 6'	\$ 187.99	\$ 176.71	
CPSFL-06096	CPSFL-06096-4K	Column - PVC, Square, Fluted Panel, 6" @ 8'	\$ 207.89	\$ 195.42	
CPSFL-06108	CPSFL-06108-4K	Column - PVC, Square, Fluted Panel, 6" @ 9'	\$ 217.84	\$ 204.77	
CPSFL-06120	CPSFL-06120-4K	Column - PVC, Square, Fluted Panel, 6" @ 10'	\$ 227.79	\$ 214.12	
CPSFL-06144	CPSFL-06144-4K	Column - PVC, Square, Fluted Panel, 6" @ 12'	\$ 247.74	\$ 232.88	
8" COLUMNS	CPSFL-08048	CPSFL-08048-4K	Column - PVC, Square, Fluted Panel, 8" @ 4'	\$ 185.41	\$ 174.29
CPSFL-08060	CPSFL-08060-4K	Column - PVC, Square, Fluted Panel, 8" @ 5'	\$ 198.68	\$ 186.76	
CPSFL-08072	CPSFL-08072-4K	Column - PVC, Square, Fluted Panel, 8" @ 6'	\$ 211.94	\$ 199.23	
CPSFL-08096	CPSFL-08096-4K	Column - PVC, Square, Fluted Panel, 8" @ 8'	\$ 238.48	\$ 224.17	
CPSFL-08108	CPSFL-08108-4K	Column - PVC, Square, Fluted Panel, 8" @ 9'	\$ 251.74	\$ 236.64	
CPSFL-08120	CPSFL-08120-4K	Column - PVC, Square, Fluted Panel, 8" @ 10'	\$ 265.01	\$ 249.11	
CPSFL-08144	CPSFL-08144-4K	Column - PVC, Square, Fluted Panel, 8" @ 12'	\$ 291.61	\$ 274.11	
10" COLUMNS	CPSFL-10048	CPSFL-10048-4K	Column - PVC, Square, Fluted Panel, 10" @ 4'	\$ 201.80	\$ 189.69
CPSFL-10060	CPSFL-10060-4K	Column - PVC, Square, Fluted Panel, 10" @ 5'	\$ 218.38	\$ 205.28	
CPSFL-10072	CPSFL-10072-4K	Column - PVC, Square, Fluted Panel, 10" @ 6'	\$ 234.97	\$ 220.87	
CPSFL-10096	CPSFL-10096-4K	Column - PVC, Square, Fluted Panel, 10" @ 8'	\$ 268.13	\$ 252.04	
CPSFL-10108	CPSFL-10108-4K	Column - PVC, Square, Fluted Panel, 10" @ 9'	\$ 284.71	\$ 267.63	
CPSFL-10120	CPSFL-10120-4K	Column - PVC, Square, Fluted Panel, 10" @ 10'	\$ 301.29	\$ 283.22	
CPSFL-10144	CPSFL-10144-4K	Column - PVC, Square, Fluted Panel, 10" @ 12'	\$ 334.55	\$ 314.48	
12" COLUMNS	CPSFL-12048	CPSFL-12048-4K	Column - PVC, Square, Fluted Panel, 12" @ 4'	\$ 218.18	\$ 205.09
CPSFL-12060	CPSFL-12060-4K	Column - PVC, Square, Fluted Panel, 12" @ 5'	\$ 238.09	\$ 223.80	
CPSFL-12072	CPSFL-12072-4K	Column - PVC, Square, Fluted Panel, 12" @ 6'	\$ 257.98	\$ 242.50	
CPSFL-12096	CPSFL-12096-4K	Column - PVC, Square, Fluted Panel, 12" @ 8'	\$ 297.78	\$ 279.92	
CPSFL-12108	CPSFL-12108-4K	Column - PVC, Square, Fluted Panel, 12" @ 9'	\$ 317.68	\$ 298.62	
CPSFL-12120	CPSFL-12120-4K	Column - PVC, Square, Fluted Panel, 12" @ 10'	\$ 337.58	\$ 317.33	
CPSFL-12144	CPSFL-12144-4K	Column - PVC, Square, Fluted Panel, 12" @ 12'	\$ 377.48	\$ 354.83	
14" COLUMNS	CPSFL-14048	CPSFL-14048-4K	Column - PVC, Square, Fluted Panel, 14" @ 4'	\$ 243.12	\$ 228.53
CPSFL-14060	CPSFL-14060-4K	Column - PVC, Square, Fluted Panel, 14" @ 5'	\$ 266.33	\$ 250.35	
CPSFL-14072	CPSFL-14072-4K	Column - PVC, Square, Fluted Panel, 14" @ 6'	\$ 289.54	\$ 272.17	
CPSFL-14096	CPSFL-14096-4K	Column - PVC, Square, Fluted Panel, 14" @ 8'	\$ 335.98	\$ 315.82	
CPSFL-14108	CPSFL-14108-4K	Column - PVC, Square, Fluted Panel, 14" @ 9'	\$ 359.19	\$ 337.64	
CPSFL-14120	CPSFL-14120-4K	Column - PVC, Square, Fluted Panel, 14" @ 10'	\$ 382.41	\$ 359.47	
CPSFL-14144	CPSFL-14144-4K	Column - PVC, Square, Fluted Panel, 14" @ 12'	\$ 428.96	\$ 403.22	

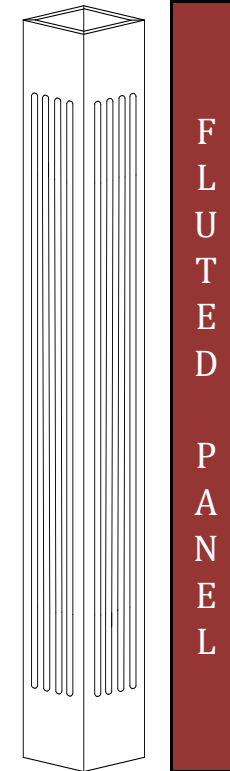

DIMS		
SIZE	OUTSIDE	INSIDE
6"	5-1/2"	4-1/2"
8"	7-1/4"	6-1/4"
10"	9-3/8"	8-3/8"
12"	11-1/2"	10-1/2"
14"	13-1/4"	12-1/4"

SQUARING "L" INCLUDED

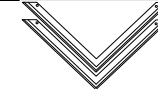

*Adds 3" to Outside Dims

*12% FOR CUSTOM HEIGHT & 12% FOR ACTUAL WIDTH
 ***FOR COLUMNS LARGER THAN 14" PLEASE CONTACT YOUR LOCAL PRESTIGE DEALER
 **PRICES SUBJECT TO CHANGE WITHOUT NOTICE



PRESTIGE COLUMNS - 2017

	PRODUCT CODE / SHAFT ONLY	PRODUCT CODE /w 4" SKIRTS	DESCRIPTION	1 PIECE	6 PIECE
8" COLUMNS	CPSRS-08048	CPSRS-08048-4K	Column - PVC, Square, Recessed Square Edge Panel, 8" @ 4'	\$ 193.00	\$ 181.42
	CPSRS-08060	CPSRS-08060-4K	Column - PVC, Square, Recessed Square Edge Panel, 8" @ 5'	\$ 212.95	\$ 200.17
	CPSRS-08072	CPSRS-08072-4K	Column - PVC, Square, Recessed Square Edge Panel, 8" @ 6'	\$ 232.89	\$ 218.92
	CPSRS-08096	CPSRS-08096-4K	Column - PVC, Square, Recessed Square Edge Panel, 8" @ 8'	\$ 272.78	\$ 256.41
	CPSRS-08108	CPSRS-08108-4K	Column - PVC, Square, Recessed Square Edge Panel, 8" @ 9'	\$ 292.73	\$ 275.17
	CPSRS-08120	CPSRS-08120-4K	Column - PVC, Square, Recessed Square Edge Panel, 8" @ 10'	\$ 312.67	\$ 293.91
	CPSRS-08144	CPSRS-08144-4K	Column - PVC, Square, Recessed Square Edge Panel, 8" @ 12'	\$ 352.56	\$ 331.41
10" COLUMNS	CPSRS-10048	CPSRS-10048-4K	Column - PVC, Square, Recessed Square Edge Panel, 10" @ 4'	\$ 216.02	\$ 203.06
	CPSRS-10060	CPSRS-10060-4K	Column - PVC, Square, Recessed Square Edge Panel, 10" @ 5'	\$ 242.12	\$ 227.59
	CPSRS-10072	CPSRS-10072-4K	Column - PVC, Square, Recessed Square Edge Panel, 10" @ 6'	\$ 268.22	\$ 252.13
	CPSRS-10096	CPSRS-10096-4K	Column - PVC, Square, Recessed Square Edge Panel, 10" @ 8'	\$ 320.42	\$ 301.20
	CPSRS-10108	CPSRS-10108-4K	Column - PVC, Square, Recessed Square Edge Panel, 10" @ 9'	\$ 346.52	\$ 325.73
	CPSRS-10120	CPSRS-10120-4K	Column - PVC, Square, Recessed Square Edge Panel, 10" @ 10'	\$ 372.62	\$ 350.26
	CPSRS-10144	CPSRS-10144-4K	Column - PVC, Square, Recessed Square Edge Panel, 10" @ 12'	\$ 424.82	\$ 399.33
12" COLUMNS	CPSRS-12048	CPSRS-12048-4K	Column - PVC, Square, Recessed Square Edge Panel, 12" @ 4'	\$ 236.68	\$ 222.48
	CPSRS-12060	CPSRS-12060-4K	Column - PVC, Square, Recessed Square Edge Panel, 12" @ 5'	\$ 267.93	\$ 251.86
	CPSRS-12072	CPSRS-12072-4K	Column - PVC, Square, Recessed Square Edge Panel, 12" @ 6'	\$ 299.19	\$ 281.24
	CPSRS-12096	CPSRS-12096-4K	Column - PVC, Square, Recessed Square Edge Panel, 12" @ 8'	\$ 361.70	\$ 340.00
	CPSRS-12108	CPSRS-12108-4K	Column - PVC, Square, Recessed Square Edge Panel, 12" @ 9'	\$ 407.07	\$ 382.64
	CPSRS-12120	CPSRS-12120-4K	Column - PVC, Square, Recessed Square Edge Panel, 12" @ 10'	\$ 424.21	\$ 398.75
	CPSRS-12144	CPSRS-12144-4K	Column - PVC, Square, Recessed Square Edge Panel, 12" @ 12'	\$ 486.71	\$ 457.51
14" COLUMNS	CPSRS-14048	CPSRS-14048-4K	Column - PVC, Square, Recessed Square Edge Panel, 14" @ 4'	\$ 264.59	\$ 248.71
	CPSRS-14060	CPSRS-14060-4K	Column - PVC, Square, Recessed Square Edge Panel, 14" @ 5'	\$ 301.83	\$ 283.72
	CPSRS-14072	CPSRS-14072-4K	Column - PVC, Square, Recessed Square Edge Panel, 14" @ 6'	\$ 339.07	\$ 318.73
	CPSRS-14096	CPSRS-14096-4K	Column - PVC, Square, Recessed Square Edge Panel, 14" @ 8'	\$ 413.55	\$ 388.74
	CPSRS-14108	CPSRS-14108-4K	Column - PVC, Square, Recessed Square Edge Panel, 14" @ 9'	\$ 450.80	\$ 423.75
	CPSRS-14120	CPSRS-14120-4K	Column - PVC, Square, Recessed Square Edge Panel, 14" @ 10'	\$ 488.04	\$ 458.76
	CPSRS-14144	CPSRS-14144-4K	Column - PVC, Square, Recessed Square Edge Panel, 14" @ 12'	\$ 562.52	\$ 528.77

***12% FOR CUSTOM HEIGHT & 12% FOR ACTUAL WIDTH**
*****FOR COLUMNS LARGER THAN 14" PLEASE CONTACT YOUR LOCAL PRESTIGE DEALER**
****PRICES SUBJECT TO CHANGE WITHOUT NOTICE**

NOTE:
 6" – 10" columns with square edge recessed panels will use either a 3/8" or a 1/2" thick backer panel.
 12" columns and larger, with square edge recessed panels, will use a 1/2" thick backer panel.
 All columns with recessed panel with base cap trim will use a 3/8" thick backer panel.

Recessed panel with base cap trim will only wrap a 5" wide structure.

PRICE LEVEL
STOCKING
Standard C&B: 4" Craftsman
CAP 4" Craftsman Skirt
BASE 4" Craftsman Skirt
<input checked="" type="checkbox"/> ADD CAP & BASE

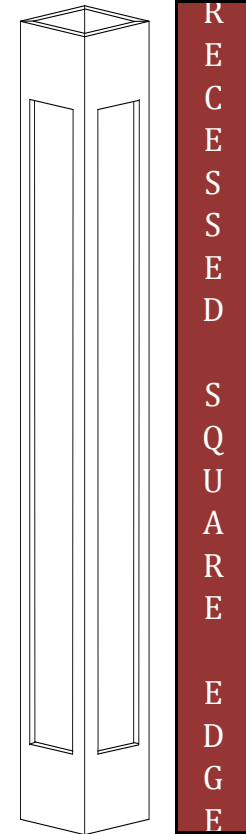

	DIMS	
SIZE	OUTSIDE	INSIDE
8"	7-1/4"	5-1/4"
10"	9-3/8"	7-3/8"
12"	11-1/2"	9-1/2"
14"	13-1/4"	11-1/4"

SQUARING "L" INCLUDED



*Adds 3" to Outside Dims



PRICE LEVEL
STOCKING
Standard C&B: 4" Craftsman
CAP 4" Craftsman Skirt
BASE 4" Craftsman Skirt
<input checked="" type="checkbox"/> ADD CAP & BASE

PRESTIGE COLUMNS - 2017

8" COLUMNS	PRODUCT CODE / SHAFT ONLY	PRODUCT CODE /w 4" SKIRTS	DESCRIPTION	1 PIECE	6 PIECE
		CPSRBF-08048	CPSRBF-08048-4K	Column - PVC, Square, Recessed Flush Trim Panel, 8" @ 4'	\$ 256.34
	CPSRBF-08060	CPSRBF-08060-4K	Column - PVC, Square, Recessed Flush Trim Panel, 8" @ 5'	\$ 284.83	\$ 267.74
	CPSRBF-08072	CPSRBF-08072-4K	Column - PVC, Square, Recessed Flush Trim Panel, 8" @ 6'	\$ 313.30	\$ 294.51
	CPSRBF-08096	CPSRBF-08096-4K	Column - PVC, Square, Recessed Flush Trim Panel, 8" @ 8'	\$ 370.26	\$ 348.05
	CPSRBF-08108	CPSRBF-08108-4K	Column - PVC, Square, Recessed Flush Trim Panel, 8" @ 9'	\$ 398.75	\$ 374.82
	CPSRBF-08120	CPSRBF-08120-4K	Column - PVC, Square, Recessed Flush Trim Panel, 8" @ 10'	\$ 427.22	\$ 401.59
	CPSRBF-08144	CPSRBF-08144-4K	Column - PVC, Square, Recessed Flush Trim Panel, 8" @ 12'	\$ 484.18	\$ 455.13
10" COLUMNS					
	CPSRBF-10048	CPSRBF-10048-4K	Column - PVC, Square, Recessed Flush Trim Panel, 10" @ 4'	\$ 279.14	\$ 262.39
	CPSRBF-10060	CPSRBF-10060-4K	Column - PVC, Square, Recessed Flush Trim Panel, 10" @ 5'	\$ 312.09	\$ 293.37
	CPSRBF-10072	CPSRBF-10072-4K	Column - PVC, Square, Recessed Flush Trim Panel, 10" @ 6'	\$ 345.05	\$ 324.35
	CPSRBF-10096	CPSRBF-10096-4K	Column - PVC, Square, Recessed Flush Trim Panel, 10" @ 8'	\$ 410.96	\$ 386.30
	CPSRBF-10108	CPSRBF-10108-4K	Column - PVC, Square, Recessed Flush Trim Panel, 10" @ 9'	\$ 443.93	\$ 417.29
	CPSRBF-10120	CPSRBF-10120-4K	Column - PVC, Square, Recessed Flush Trim Panel, 10" @ 10'	\$ 476.88	\$ 448.27
	CPSRBF-10144	CPSRBF-10144-4K	Column - PVC, Square, Recessed Flush Trim Panel, 10" @ 12'	\$ 542.80	\$ 510.23
12" COLUMNS					
	CPSRBF-12048	CPSRBF-12048-4K	Column - PVC, Square, Recessed Flush Trim Panel, 12" @ 4'	\$ 301.29	\$ 283.22
	CPSRBF-12060	CPSRBF-12060-4K	Column - PVC, Square, Recessed Flush Trim Panel, 12" @ 5'	\$ 338.73	\$ 318.41
	CPSRBF-12072	CPSRBF-12072-4K	Column - PVC, Square, Recessed Flush Trim Panel, 12" @ 6'	\$ 376.16	\$ 353.59
	CPSRBF-12096	CPSRBF-12096-4K	Column - PVC, Square, Recessed Flush Trim Panel, 12" @ 8'	\$ 451.03	\$ 423.97
	CPSRBF-12108	CPSRBF-12108-4K	Column - PVC, Square, Recessed Flush Trim Panel, 12" @ 9'	\$ 488.46	\$ 459.16
	CPSRBF-12120	CPSRBF-12120-4K	Column - PVC, Square, Recessed Flush Trim Panel, 12" @ 10'	\$ 525.89	\$ 494.34
	CPSRBF-12144	CPSRBF-12144-4K	Column - PVC, Square, Recessed Flush Trim Panel, 12" @ 12'	\$ 600.76	\$ 564.72
14" COLUMNS					
	CPSRBF-14048	CPSRBF-14048-4K	Column - PVC, Square, Recessed Flush Trim Panel, 14" @ 4'	\$ 332.53	\$ 312.58
	CPSRBF-14060	CPSRBF-14060-4K	Column - PVC, Square, Recessed Flush Trim Panel, 14" @ 5'	\$ 374.44	\$ 351.97
	CPSRBF-14072	CPSRBF-14072-4K	Column - PVC, Square, Recessed Flush Trim Panel, 14" @ 6'	\$ 416.35	\$ 391.37
	CPSRBF-14096	CPSRBF-14096-4K	Column - PVC, Square, Recessed Flush Trim Panel, 14" @ 8'	\$ 500.17	\$ 470.16
	CPSRBF-14108	CPSRBF-14108-4K	Column - PVC, Square, Recessed Flush Trim Panel, 14" @ 9'	\$ 542.08	\$ 509.55
	CPSRBF-14120	CPSRBF-14120-4K	Column - PVC, Square, Recessed Flush Trim Panel, 14" @ 10'	\$ 583.99	\$ 548.95
	CPSRBF-14144	CPSRBF-14144-4K	Column - PVC, Square, Recessed Flush Trim Panel, 14" @ 12'	\$ 667.81	\$ 627.74

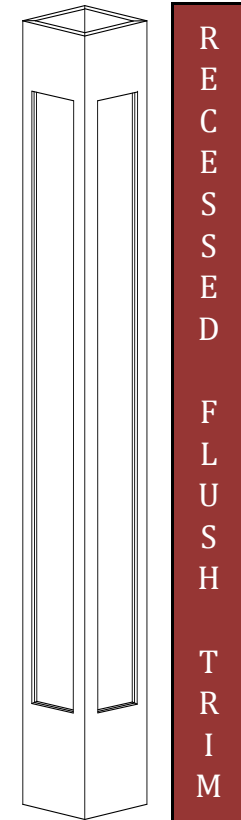

*12% FOR CUSTOM HEIGHT & 12% FOR ACTUAL WIDTH
 ***FOR COLUMNS LARGER THAN 14" PLEASE CONTACT YOUR LOCAL PRESTIGE DEALER
 **PRICES SUBJECT TO CHANGE WITHOUT NOTICE

NOTE:

6" – 10" columns with square edge recessed panels will use either a 3/8" or a 1/2" thick backer panel.
 12" columns and larger, with square edge recessed panels, will use a 1/2" thick backer panel.
 All columns with recessed panel with base cap trim will use a 3/8" thick backer panel.

Recessed panel with base cap trim will only wrap a 5" wide structure.

SIZE	DIMS	
	OUTSIDE	INSIDE
8"	7-1/4"	5-1/4"
10"	9-3/8"	7-3/8"
12"	11-1/2"	9-1/2"
14"	13-1/4"	11-1/4"

SQUARING "L" INCLUDED

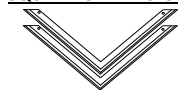

*Adds 3" to Outside Dims



PRICE LEVEL
STOCKING
Standard C&B: 4" Craftsman
CAP 4" Craftsman Skirt
BASE 4" Craftsman Skirt
<input checked="" type="checkbox"/> ADD CAP & BASE

PRESTIGE COLUMNS - 2017

8" COLUMNS

PRODUCT CODE / SHAFT ONLY	PRODUCT CODE /w 4" SKIRTS	DESCRIPTION	1 PIECE	6 PIECE
CPSRBF-08048	CPSRBR-08048-4K	Column - PVC, Square, Recessed Raised Trim Panel, 8" @ 4'	\$ 256.79	\$ 241.38
CPSRBF-08060	CPSRBR-08060-4K	Column - PVC, Square, Recessed Raised Trim Panel, 8" @ 5'	\$ 285.32	\$ 268.20
CPSRBF-08072	CPSRBR-08072-4K	Column - PVC, Square, Recessed Raised Trim Panel, 8" @ 6'	\$ 313.86	\$ 295.03
CPSRBF-08096	CPSRBR-08096-4K	Column - PVC, Square, Recessed Raised Trim Panel, 8" @ 8'	\$ 370.93	\$ 348.67
CPSRBF-08108	CPSRBR-08108-4K	Column - PVC, Square, Recessed Raised Trim Panel, 8" @ 9'	\$ 399.46	\$ 375.49
CPSRBF-08120	CPSRBR-08120-4K	Column - PVC, Square, Recessed Raised Trim Panel, 8" @ 10'	\$ 427.99	\$ 402.31
CPSRBF-08144	CPSRBR-08144-4K	Column - PVC, Square, Recessed Raised Trim Panel, 8" @ 12'	\$ 485.06	\$ 455.96

10" COLUMNS

CPSRBF-10048	CPSRBR-10048-4K	Column - PVC, Square, Recessed Raised Trim Panel, 10" @ 4'	\$ 279.62	\$ 262.85
CPSRBF-10060	CPSRBR-10060-4K	Column - PVC, Square, Recessed Raised Trim Panel, 10" @ 5'	\$ 312.64	\$ 293.88
CPSRBF-10072	CPSRBR-10072-4K	Column - PVC, Square, Recessed Raised Trim Panel, 10" @ 6'	\$ 345.66	\$ 324.92
CPSRBF-10096	CPSRBR-10096-4K	Column - PVC, Square, Recessed Raised Trim Panel, 10" @ 8'	\$ 411.69	\$ 386.99
CPSRBF-10108	CPSRBR-10108-4K	Column - PVC, Square, Recessed Raised Trim Panel, 10" @ 9'	\$ 444.72	\$ 418.04
CPSRBF-10120	CPSRBR-10120-4K	Column - PVC, Square, Recessed Raised Trim Panel, 10" @ 10'	\$ 477.74	\$ 449.07
CPSRBF-10144	CPSRBR-10144-4K	Column - PVC, Square, Recessed Raised Trim Panel, 10" @ 12'	\$ 543.77	\$ 511.14

12" COLUMNS

CPSRBF-12048	CPSRBR-12048-4K	Column - PVC, Square, Recessed Raised Trim Panel, 12" @ 4'	\$ 301.81	\$ 283.70
CPSRBF-12060	CPSRBR-12060-4K	Column - PVC, Square, Recessed Raised Trim Panel, 12" @ 5'	\$ 339.32	\$ 318.96
CPSRBF-12072	CPSRBR-12072-4K	Column - PVC, Square, Recessed Raised Trim Panel, 12" @ 6'	\$ 376.82	\$ 354.21
CPSRBF-12096	CPSRBR-12096-4K	Column - PVC, Square, Recessed Raised Trim Panel, 12" @ 8'	\$ 451.84	\$ 424.73
CPSRBF-12108	CPSRBR-12108-4K	Column - PVC, Square, Recessed Raised Trim Panel, 12" @ 9'	\$ 489.33	\$ 459.97
CPSRBF-12120	CPSRBR-12120-4K	Column - PVC, Square, Recessed Raised Trim Panel, 12" @ 10'	\$ 526.84	\$ 495.23
CPSRBF-12144	CPSRBR-12144-4K	Column - PVC, Square, Recessed Raised Trim Panel, 12" @ 12'	\$ 601.85	\$ 565.74

14" COLUMNS

CPSRBF-14048	CPSRBR-14048-4K	Column - PVC, Square, Recessed Raised Trim Panel, 14" @ 4'	\$ 333.10	\$ 313.11
CPSRBF-14060	CPSRBR-14060-4K	Column - PVC, Square, Recessed Raised Trim Panel, 14" @ 5'	\$ 375.09	\$ 352.58
CPSRBF-14072	CPSRBR-14072-4K	Column - PVC, Square, Recessed Raised Trim Panel, 14" @ 6'	\$ 417.08	\$ 392.06
CPSRBF-14096	CPSRBR-14096-4K	Column - PVC, Square, Recessed Raised Trim Panel, 14" @ 8'	\$ 501.06	\$ 471.00
CPSRBF-14108	CPSRBR-14108-4K	Column - PVC, Square, Recessed Raised Trim Panel, 14" @ 9'	\$ 543.05	\$ 510.46
CPSRBF-14120	CPSRBR-14120-4K	Column - PVC, Square, Recessed Raised Trim Panel, 14" @ 10'	\$ 585.03	\$ 549.93
CPSRBF-14144	CPSRBR-14144-4K	Column - PVC, Square, Recessed Raised Trim Panel, 14" @ 12'	\$ 669.01	\$ 628.87

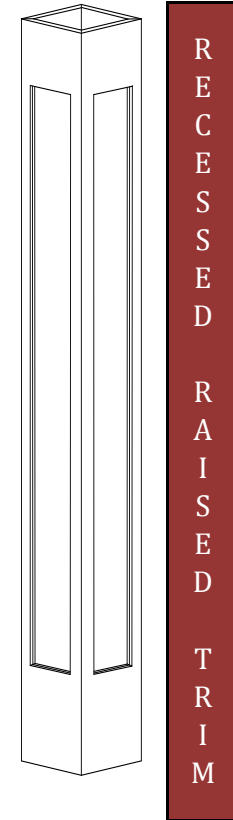

***12% FOR CUSTOM HEIGHT & 12% FOR ACTUAL WIDTH**
*****FOR COLUMNS LARGER THAN 14" PLEASE CONTACT YOUR LOCAL PRESTIGE DEALER**
****PRICES SUBJECT TO CHANGE WITHOUT NOTICE**

NOTE:
 6" – 10" columns with square edge recessed panels will use either a 3/8" or a 1/2" thick backer panel.
 12" columns and larger, with square edge recessed panels, will use a 1/2" thick backer panel.
 All columns with recessed panel with base cap trim will use a 3/8" thick backer panel.

Recessed panel with base cap trim will only wrap a 5" wide structure.

DIMS		
SIZE	OUTSIDE	INSIDE
8"	7-1/4"	5-1/4"
10"	9-3/8"	7-3/8"
12"	11-1/2"	9-1/2"
14"	13-1/4"	11-1/4"

SQUARING "L" INCLUDED

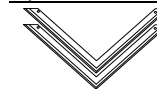

***Adds 3" to Outside Dims**

PRESTIGE COLUMNS - 2017

C
A
P
&
B
A
S
E
O
P
T
I
O
N
S

6" COLUMNS

PRODUCT CODE	DESCRIPTION	SINGLE SKIRT	SKIRT SET
CSP314	Skirt-PVC,CMN-6"Col-4"	\$ 8.32	\$ 16.64
CSP316	Skirt-PVC,CMN-6"Col-6"	\$ 9.45	\$ 18.91
CSP318	Skirt-PVC,CMN-6"Col-8"	\$ 10.44	\$ 20.88
CSP116	Skirt-PVC,BSE CP-6"Col-6"	\$ 20.22	\$ 40.45
CSP118	Skirt-PVC,BSE CP-6"Col-8"	\$ 22.25	\$ 44.50
CSP414	Skirt-PVC,CRWN-6"Col-4"	\$ 26.53	\$ 53.07
CSP415	Skirt-PVC,CRWN-6"Col-5"	\$ 35.76	\$ 71.53
CSP416	Skirt-PVC,CRWN-6"Col-6"	\$ 41.20	\$ 82.40
CSP616	Skirt-PVC,TSCN-6"Col-6"	\$ 35.65	\$ 71.30
CSP618	Skirt-PVC,TSCN-6"Col-8"	\$ 39.33	\$ 78.67
CSP61A	Skirt-PVC,TSCN-6"Col-10"	\$ 43.02	\$ 86.05
CSP716	Skirt-PVC,CHMFRD-6"Col-6"	\$ 28.87	\$ 57.74
CSP718	Skirt-PVC,CHMFRD-6"Col-8"	\$ 32.55	\$ 65.11
CSP71A	Skirt-PVC,CHMFRD-6"Col-10"	\$ 36.24	\$ 72.48
CSP512	Skirt-PVC,SLD CRWN-6"Col-2"	\$ 21.22	\$ 42.44
ASTRG-0606	Astragal-PVC, BSE CP-6" Col	\$ 25.69	

8" COLUMNS

CSP324	Skirt-PVC,CMN-8"Col-4"	\$ 9.89	\$ 19.78
CSP326	Skirt-PVC,CMN-8"Col-6"	\$ 10.52	\$ 21.05
CSP328	Skirt-PVC,CMN-8"Col-8"	\$ 11.78	\$ 23.56
CSP126	Skirt-PVC,BSE CP-8"Col-6"	\$ 26.97	\$ 53.93
CSP128	Skirt-PVC,BSE CP-8"Col-8"	\$ 29.66	\$ 59.33
CSP424	Skirt-PVC,CRWN-8"Col-4"	\$ 30.46	\$ 60.93
CSP425	Skirt-PVC,CRWN-8"Col-5"	\$ 38.95	\$ 77.90
CSP426	Skirt-PVC,CRWN-8"Col-6"	\$ 44.60	\$ 89.20
CSP626	Skirt-PVC,TSCN-8"Col-6"	\$ 38.70	\$ 77.40
CSP628	Skirt-PVC,TSCN-8"Col-8"	\$ 43.41	\$ 86.81
CSP62A	Skirt-PVC,TSCN-8"Col-10"	\$ 48.12	\$ 96.23
CSP726	Skirt-PVC,CHMFRD-8"Col-6"	\$ 31.92	\$ 63.84
CSP728	Skirt-PVC,CHMFRD-8"Col-8"	\$ 36.63	\$ 73.26
CSP72A	Skirt-PVC,CHMFRD-8"Col-10"	\$ 41.33	\$ 82.67
CSP522	Skirt-PVC,SLD CRWN-8"Col-2"	\$ 23.56	\$ 47.12
ASTRG-0808	Astragal-PVC, BSE CP-8" Col	\$ 29.42	

10" COLUMNS

CSP334	Skirt-PVC,CMN-10"col-4"	\$ 11.00	\$ 22.01
CSP336	Skirt-PVC,CMN-10"col-6"	\$ 16.56	\$ 33.12
CSP338	Skirt-PVC,CMN-10"col-8"	\$ 19.63	\$ 39.25
CSP136	Skirt-PVC,BSE CP-10"col-6"	\$ 33.71	\$ 67.41
CSP138	Skirt-PVC,BSE CP-10"col-8"	\$ 37.08	\$ 74.17
CSP434	Skirt-PVC,CRWN-10"col-4"	\$ 30.98	\$ 61.95
CSP435	Skirt-PVC,CRWN-10"col-5"	\$ 42.14	\$ 84.28
CSP436	Skirt-PVC,CRWN-10"col-6"	\$ 48.00	\$ 96.00
CSP636	Skirt-PVC,TSCN-10"col-6"	\$ 41.76	\$ 83.52
CSP638	Skirt-PVC,TSCN-10"col-8"	\$ 47.48	\$ 94.95
CSP63A	Skirt-PVC,TSCN-10"col-10"	\$ 53.20	\$ 106.41
CSP736	Skirt-PVC,CHMFRD-10"col-6"	\$ 34.98	\$ 69.95
CSP738	Skirt-PVC,CHMFRD-10"col-8"	\$ 40.69	\$ 81.39
CSP73A	Skirt-PVC,CHMFRD-10"col-10"	\$ 46.42	\$ 92.84
CSP532	Skirt-PVC,SLD CRWN-10"col-2"	\$ 25.91	\$ 51.82
ASTRG-1010	Astragal-PVC, BSE CP-10" Col	\$ 30.99	

C
A
P
&
B
A
S
E

O
P
T
I
O
N
S

12" COLUMNS

CSP344	Skirt-PVC,CMN-12"col-4"	\$ 12.11	\$ 24.22
CSP346	Skirt-PVC,CMN-12"col-6"	\$ 18.27	\$ 36.55
CSP348	Skirt-PVC,CMN-12"col-8"	\$ 21.88	\$ 43.77
CSP146	Skirt-PVC,BSE CP-12"col-6"	\$ 40.45	\$ 80.90
CSP148	Skirt-PVC,BSE CP-12"col-8"	\$ 44.50	\$ 88.99
CSP444	Skirt-PVC,CRWN-12"col-4"	\$ 33.18	\$ 66.35
CSP445	Skirt-PVC,CRWN-12"col-5"	\$ 45.33	\$ 90.66
CSP446	Skirt-PVC,CRWN-12"col-6"	\$ 51.40	\$ 102.79
CSP645	Skirt-PVC,TSCN-12"col-5"	\$ 41.44	\$ 82.88
CSP646	Skirt-PVC,TSCN-12"col-6"	\$ 44.81	\$ 89.61
CSP648	Skirt-PVC,TSCN-12"col-8"	\$ 51.55	\$ 103.10
CSP64A	Skirt-PVC,TSCN-12"col-10"	\$ 58.29	\$ 116.58
CSP746	Skirt-PVC,CHMFRD-12"col-6"	\$ 38.02	\$ 76.05
CSP748	Skirt-PVC,CHMFRD-12"col-8"	\$ 44.77	\$ 89.54
CSP74A	Skirt-PVC,CHMFRD-12"col-10"	\$ 51.51	\$ 103.01
CSP542	Skirt-PVC,SLD CRWN-12"col-2"	\$ 28.25	\$ 56.51
ASTRG-1212	Astragal-PVC, BSE CP-12" Col	\$ 32.57	

14" COLUMNS

CSP354	Skirt-PVC,CMN-14"col-4"	\$ 15.86	\$ 31.71
CSP356	Skirt-PVC,CMN-14"col-6"	\$ 23.98	\$ 47.97
CSP358	Skirt-PVC,CMN-14"col-8"	\$ 28.96	\$ 57.91
CSP156	Skirt-PVC,BSE CP-14"col-6"	\$ 56.63	\$ 113.26
CSP158	Skirt-PVC,BSE CP-14"col-8"	\$ 62.30	\$ 124.59
CSP454	Skirt-PVC,CRWN-14"col-4"	\$ 42.47	\$ 84.95
CSP455	Skirt-PVC,CRWN-14"col-5"	\$ 58.21	\$ 116.43
CSP456	Skirt-PVC,CRWN-14"col-6"	\$ 65.76	\$ 131.53
CSP656	Skirt-PVC,TSCN-14"col-6"	\$ 57.43	\$ 114.86
CSP658	Skirt-PVC,TSCN-14"col-8"	\$ 66.74	\$ 133.48
CSP65A	Skirt-PVC,TSCN-14"col-10"	\$ 76.06	\$ 152.12
CSP756	Skirt-PVC,CHMFRD-14"col-6"	\$ 49.29	\$ 98.59
CSP758	Skirt-PVC,CHMFRD-14"col-8"	\$ 58.61	\$ 117.21
CSP75A	Skirt-PVC,CHMFRD-14"col-10"	\$ 67.92	\$ 135.84
CSP552	Skirt-PVC,SLD CRWN-14"col-2"	\$ 36.72	\$ 73.44
ASTRG-1414	Astragal-PVC, BSE CP-14" Col	\$ 41.00	

**PRICES SUBJECT TO CHANGE WITHOUT NOTICE

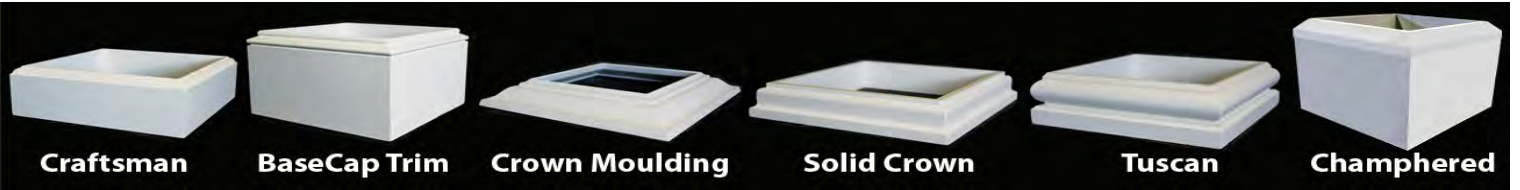

Craftsman

BaseCap Trim

Crown Moulding

Solid Crown

Tuscan

Champhered



CUSTOM COLUMN LAYOUT

CLIENT INFORMATION

Dealer Name: _____

Project: _____

PO#: _____

Project Contact: _____

Date: _____

Approved By: _____

PANEL SIZES

1. Height (Y")

2. Top Width (X")

3. Bottom Width (XX")

Note: Tapered column panels are always actual dimensions.

3. Inside Dims

4. Painted No

Yes

Colour: _____

REVEALS

R*. All bottom and top panel reveals will be adjusted to 2" above and below chosen joints.

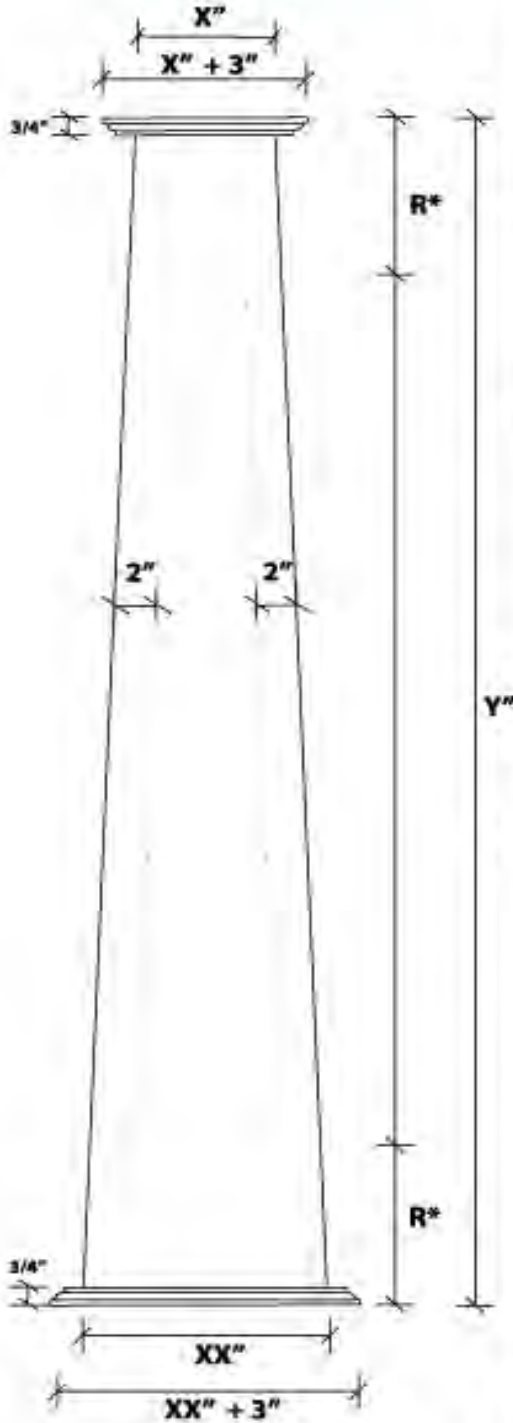

PANEL PROFILE

- | | |
|--------------------|--------------------------|
| 1. Plain | <input type="checkbox"/> |
| 2. Fluted | <input type="checkbox"/> |
| 3. Raised | <input type="checkbox"/> |
| 4. Recessed | <input type="checkbox"/> |
| • Square Edge | <input type="checkbox"/> |
| • Round Edge | <input type="checkbox"/> |
| • w/ Base Cap Trim | <input type="checkbox"/> |
| • Flush Trim | <input type="checkbox"/> |
| • Raised Trim | <input type="checkbox"/> |

- | | |
|--------------------|--------------------------|
| 1. Single Panel | <input type="checkbox"/> |
| 2. Double Panel | <input type="checkbox"/> |
| 3. 1/3 - 2/3 Panel | <input type="checkbox"/> |
| 4. Custom | <input type="checkbox"/> |

NOTES:

Panel Locks: M F

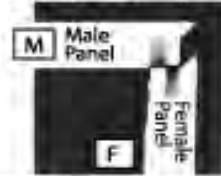

CAPS & BASES

Craftsman



- 4"
6"
8"
10"

Crown Mould



- 4"
5"
6"

Tuscan



- 4"
6"
8"
10"

Place a 'T' for Column Top
Place 'B' for Column Bottom

Base Cap Edge



- 4"
6"
8"
10"

Solid Crown



1.
2.

****Note:** For more column dimension information see Prestige Column Reference Guide (On Reverse).
All approved custom column orders are non-refundable.

Ver 2, 06-16

Prestige Column Sizes & Reveals - Tapered Columns

Product Code	Prestige PVC Tapered Columns	Base Width (inches)	Top Width (inches)	Interior Base Width (inches)	Interior Top Width (inches)	Column Height (ft)	Column Weight (lbs)
CPTPL-0906-048	Prestige Column - PVC, Square Tapered, Plain Panel, 9" x 6" x 4'	9"	6"	8"	5"	48	40
CPTPL-0906-060	Prestige Column - PVC, Square Tapered, Plain Panel, 9" x 6" x 5'	9"	6"	8"	5"	60	49
CPTPL-0906-072	Prestige Column - PVC, Square Tapered, Plain Panel, 9" x 6" x 6'	9"	6"	8"	5"	72	49
CPTPL-1208-048	Prestige Column - PVC, Square Tapered, Plain Panel, 12" x 8" x 4'	12"	8"	11"	7"	48	40
CPTPL-1208-060	Prestige Column - PVC, Square Tapered, Plain Panel, 12" x 8" x 5'	12"	8"	11"	7"	60	49
CPTPL-1208-072	Prestige Column - PVC, Square Tapered, Plain Panel, 12" x 8" x 6'	12"	8"	11"	7"	72	49
CPTPL-1309-048	Prestige Column - PVC, Square Tapered, Plain Panel, 13" x 9" x 4'	13"	9"	12"	8"	48	40
CPTPL-1309-060	Prestige Column - PVC, Square Tapered, Plain Panel, 13" x 9" x 5'	13"	9"	12"	8"	60	49
CPTPL-1309-072	Prestige Column - PVC, Square Tapered, Plain Panel, 13" x 9" x 6'	13"	9"	12"	8"	72	49
CPTPL-1612-048	Prestige Column - PVC, Square Tapered, Plain Panel, 16" x 12" x 4'	16"	12"	15"	11"	48	40
CPTPL-1612-060	Prestige Column - PVC, Square Tapered, Plain Panel, 16" x 12" x 5'	16"	12"	15"	11"	60	49
CPTPL-1612-072	Prestige Column - PVC, Square Tapered, Plain Panel, 16" x 12" x 6'	16"	12"	15"	11"	72	49

Packaging- Standard Kit consists of boxed, 4 column panels, cap/base c/w non fastener strip, squaring corners, adhesive, fasteners, instructions & warranty

Prestige Columns™ - Double Panel 10% for all Columns	Prestige Columns™ - Actual Size 10% for all Columns	Prestige Columns™ - Paint Services 30% for all Columns
--	---	--

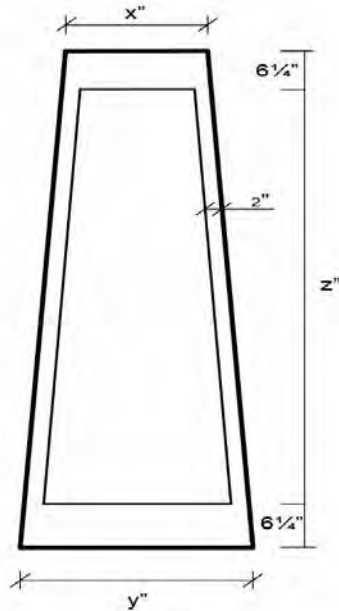



PRICE LEVEL
STOCKING
Standard C&B: 4" Craftsman
CAP 4" Craftsman Skirt Set
BASE 4" Craftsman Skirt Set
<input checked="" type="checkbox"/> ADD CAP & BASE

PRESTIGE COLUMNS - 2017

9" - 6" TAPERED COLUMNS

PRODUCT CODE / SHAFT ONLY
CPTPL-0906048
CPTPL-0906060
CPTPL-0906072
CPTPL-0906096
CPTPL-0906120
CPTPL-0906144

PRODUCT CODE /w 4" SKIRTS
CPTPL-0906048-4K
CPTPL-0906060-4K
CPTPL-0906072-4K
CPTPL-0906096-4K
CPTPL-0906120-4K
CPTPL-0906144-4K

DESCRIPTION
Column - PVC, Tapered, Plain Panel, 9"-6" @ 4'
Column - PVC, Tapered, Plain Panel, 9"-6" @ 5'
Column - PVC, Tapered, Plain Panel, 9"-6" @ 6'
Column - PVC, Tapered, Plain Panel, 9"-6" @ 8'
Column - PVC, Tapered, Plain Panel, 9"-6" @ 10'
Column - PVC, Tapered, Plain Panel, 9"-6" @ 12'

1 PIECE	6 PIECE
\$ 156.94	\$ 147.52
\$ 168.91	\$ 158.78
\$ 180.88	\$ 170.03
\$ 204.82	\$ 192.53
\$ 228.77	\$ 215.04
\$ 252.77	\$ 237.60

12" - 8" TAPERED COLUMNS

CPTPL-1208048
CPTPL-1208060
CPTPL-1208072
CPTPL-1208096
CPTPL-1208120
CPTPL-1208144

CPTPL-1208048-4K
CPTPL-1208060-4K
CPTPL-1208072-4K
CPTPL-1208096-4K
CPTPL-1208120-4K
CPTPL-1208144-4K

Column - PVC, Tapered, Plain Panel, 12"-8" @ 4'
Column - PVC, Tapered, Plain Panel, 12"-8" @ 5'
Column - PVC, Tapered, Plain Panel, 12"-8" @ 6'
Column - PVC, Tapered, Plain Panel, 12"-8" @ 8'
Column - PVC, Tapered, Plain Panel, 12"-8" @ 10'
Column - PVC, Tapered, Plain Panel, 12"-8" @ 12'

\$ 177.34	\$ 166.70
\$ 193.29	\$ 181.70
\$ 209.26	\$ 196.70
\$ 241.18	\$ 226.71
\$ 273.10	\$ 256.72
\$ 305.11	\$ 286.80

13" - 9" TAPERED COLUMNS

CPTPL-1309048
CPTPL-1309060
CPTPL-1309072
CPTPL-1309096
CPTPL-1309120
CPTPL-1309144

CPTPL-1309048-4K
CPTPL-1309060-4K
CPTPL-1309072-4K
CPTPL-1309096-4K
CPTPL-1309120-4K
CPTPL-1309144-4K

Column - PVC, Tapered, Plain Panel, 13"-9" @ 4'
Column - PVC, Tapered, Plain Panel, 13"-9" @ 5'
Column - PVC, Tapered, Plain Panel, 13"-9" @ 6'
Column - PVC, Tapered, Plain Panel, 13"-9" @ 8'
Column - PVC, Tapered, Plain Panel, 13"-9" @ 10'
Column - PVC, Tapered, Plain Panel, 13"-9" @ 12'

\$ 185.47	\$ 174.34
\$ 203.01	\$ 190.83
\$ 220.58	\$ 207.34
\$ 255.70	\$ 240.36
\$ 290.81	\$ 273.36
\$ 326.02	\$ 306.46

16" - 12" TAPERED COLUMNS

CPTPL-1612048
CPTPL-1612060
CPTPL-1612072
CPTPL-1612096
CPTPL-1612120
CPTPL-1612144

CPTPL-1612048-4K
CPTPL-1612060-4K
CPTPL-1612072-4K
CPTPL-1612096-4K
CPTPL-1612120-4K
CPTPL-1612144-4K

Column - PVC, Tapered, Plain Panel, 16"-12" @ 4'
Column - PVC, Tapered, Plain Panel, 16"-12" @ 5'
Column - PVC, Tapered, Plain Panel, 16"-12" @ 6'
Column - PVC, Tapered, Plain Panel, 16"-12" @ 8'
Column - PVC, Tapered, Plain Panel, 16"-12" @ 10'
Column - PVC, Tapered, Plain Panel, 16"-12" @ 12'

\$ 209.83	\$ 197.24
\$ 232.18	\$ 218.25
\$ 254.52	\$ 239.25
\$ 299.22	\$ 281.27
\$ 343.91	\$ 323.28
\$ 388.72	\$ 365.40

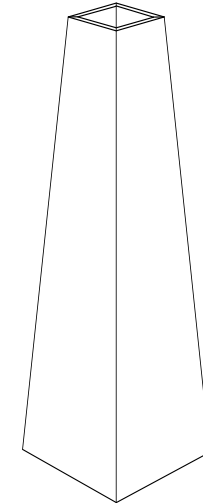

TAPERED PLAIN

*12% FOR CUSTOM HEIGHT
**PRICES SUBJECT TO CHANGE WITHOUT NOTICE

DIMS			
OUTSIDE		INSIDE	
TOP	BOTTOM	TOP	BOTTOM
6"	9"	5"	8"
8"	12"	7"	11"
9"	13"	8"	12"
12"	16"	11"	15"

SQUARING "L" INCLUDED



*Adds 3" to Outside Dims



PRICE LEVEL
STOCKING
Standard C&B: 4" Craftsman
CAP 4" Craftsman Skirt Set
BASE 4" Craftsman Skirt Set
<input checked="" type="checkbox"/> ADD CAP & BASE

PRESTIGE COLUMNS - 2017

9" - 6" TAPERED COLUMNS

PRODUCT CODE / SHAFT ONLY
CPTRA-0906048
CPTRA-0906060
CPTRA-0906072
CPTRA-0906096
CPTRA-0906120
CPTRA-0906144

PRODUCT CODE /w 4" SKIRTS
CPTRA-0906048-4K
CPTRA-0906060-4K
CPTRA-0906072-4K
CPTRA-0906096-4K
CPTRA-0906120-4K
CPTRA-0906144-4K

DESCRIPTION
Column - PVC, Tapered, Raised Panel, 9"-6" @ 4'
Column - PVC, Tapered, Raised Panel, 9"-6" @ 5'
Column - PVC, Tapered, Raised Panel, 9"-6" @ 6'
Column - PVC, Tapered, Raised Panel, 9"-6" @ 8'
Column - PVC, Tapered, Raised Panel, 9"-6" @ 10'
Column - PVC, Tapered, Raised Panel, 9"-6" @ 12'

1 PIECE	6 PIECE
\$ 184.22	\$ 173.17
\$ 196.20	\$ 184.43
\$ 208.16	\$ 195.67
\$ 232.87	\$ 218.89
\$ 256.05	\$ 240.68
\$ 280.06	\$ 263.25

12" - 8" TAPERED COLUMNS

CPTRA-1208048
CPTRA-1208060
CPTRA-1208072
CPTRA-1208096
CPTRA-1208120
CPTRA-1208144

CPTRA-1208048-4K
CPTRA-1208060-4K
CPTRA-1208072-4K
CPTRA-1208096-4K
CPTRA-1208120-4K
CPTRA-1208144-4K

Column - PVC, Tapered, Raised Panel, 12"-8" @ 4'
Column - PVC, Tapered, Raised Panel, 12"-8" @ 5'
Column - PVC, Tapered, Raised Panel, 12"-8" @ 6'
Column - PVC, Tapered, Raised Panel, 12"-8" @ 8'
Column - PVC, Tapered, Raised Panel, 12"-8" @ 10'
Column - PVC, Tapered, Raised Panel, 12"-8" @ 12'

\$ 204.62	\$ 192.34
\$ 220.57	\$ 207.34
\$ 236.54	\$ 222.34
\$ 268.46	\$ 252.36
\$ 300.38	\$ 282.36
\$ 332.39	\$ 312.45

13" - 9" TAPERED COLUMNS

CPTRA-1309048
CPTRA-1309060
CPTRA-1309072
CPTRA-1309096
CPTRA-1309120
CPTRA-1309144

CPTRA-1309048-4K
CPTRA-1309060-4K
CPTRA-1309072-4K
CPTRA-1309096-4K
CPTRA-1309120-4K
CPTRA-1309144-4K

Column - PVC, Tapered, Raised Panel, 13"-9" @ 4'
Column - PVC, Tapered, Raised Panel, 13"-9" @ 5'
Column - PVC, Tapered, Raised Panel, 13"-9" @ 6'
Column - PVC, Tapered, Raised Panel, 13"-9" @ 8'
Column - PVC, Tapered, Raised Panel, 13"-9" @ 10'
Column - PVC, Tapered, Raised Panel, 13"-9" @ 12'

\$ 212.75	\$ 199.98
\$ 230.31	\$ 216.49
\$ 247.87	\$ 232.99
\$ 282.98	\$ 266.00
\$ 318.10	\$ 299.01
\$ 353.30	\$ 332.11

16" - 12" TAPERED COLUMNS

CPTRA-1612048
CPTRA-1612060
CPTRA-1612072
CPTRA-1612096
CPTRA-1612120
CPTRA-1612144

CPTRA-1612048-4K
CPTRA-1612060-4K
CPTRA-1612072-4K
CPTRA-1612096-4K
CPTRA-1612120-4K
CPTRA-1612144-4K

Column - PVC, Tapered, Raised Panel, 16"-12" @ 4'
Column - PVC, Tapered, Raised Panel, 16"-12" @ 5'
Column - PVC, Tapered, Raised Panel, 16"-12" @ 6'
Column - PVC, Tapered, Raised Panel, 16"-12" @ 8'
Column - PVC, Tapered, Raised Panel, 16"-12" @ 10'
Column - PVC, Tapered, Raised Panel, 16"-12" @ 12'

\$ 237.12	\$ 222.89
\$ 259.46	\$ 243.89
\$ 281.81	\$ 264.90
\$ 326.51	\$ 306.92
\$ 371.19	\$ 348.92
\$ 416.01	\$ 391.05

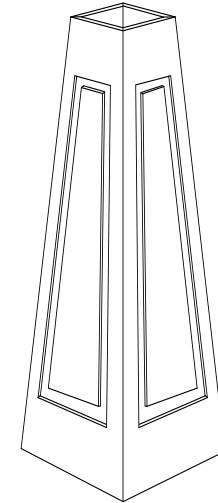

TAPERED RAISED PANEL

*12% FOR CUSTOM HEIGHT
**PRICES SUBJECT TO CHANGE WITHOUT NOTICE

DIMS			
OUTSIDE		INSIDE	
TOP	BOTTOM	TOP	BOTTOM
6"	9"	5"	8"
8"	12"	7"	11"
9"	13"	8"	12"
12"	16"	11"	15"

SQUARING "L" INCLUDED

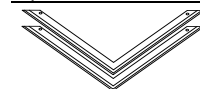

*Adds 3" to Outside Dims



PRICE LEVEL
STOCKING
Standard C&B: 4" Craftsman
CAP 4" Craftsman Skirt Set
BASE 4" Craftsman Skirt Set
<input checked="" type="checkbox"/> ADD CAP & BASE

PRESTIGE COLUMNS - 2017

12" - 8" TAPERED COLUMNS

PRODUCT CODE / SHAFT ONLY
CPTRS-1208048
CPTRS-1208060
CPTRS-1208072
CPTRS-1208096
CPTRS-1208120
CPTRS-1208144

PRODUCT CODE /w 4" SKIRTS
CPTRS-1208048-4K
CPTRS-1208060-4K
CPTRS-1208072-4K
CPTRS-1208096-4K
CPTRS-1208120-4K
CPTRS-1208144-4K

DESCRIPTION
Column - PVC, Tapered, Recessed Square Edge Panel, 12"-8" @ 4'
Column - PVC, Tapered, Recessed Square Edge Panel, 12"-8" @ 5'
Column - PVC, Tapered, Recessed Square Edge Panel, 12"-8" @ 6'
Column - PVC, Tapered, Recessed Square Edge Panel, 12"-8" @ 8'
Column - PVC, Tapered, Recessed Square Edge Panel, 12"-8" @ 10'
Column - PVC, Tapered, Recessed Square Edge Panel, 12"-8" @ 12'

1 PIECE	6 PIECE
\$ 219.60	\$ 206.43
\$ 246.08	\$ 231.32
\$ 272.56	\$ 256.20
\$ 325.52	\$ 305.99
\$ 378.48	\$ 355.77
\$ 431.52	\$ 405.63

13" - 9" TAPERED COLUMNS

CPTRS-1309048
CPTRS-1309060
CPTRS-1309072
CPTRS-1309096
CPTRS-1309120
CPTRS-1309144

CPTRS-1309048-4K
CPTRS-1309060-4K
CPTRS-1309072-4K
CPTRS-1309096-4K
CPTRS-1309120-4K
CPTRS-1309144-4K

Column - PVC, Tapered, Recessed Square Edge Panel, 13"-9" @ 4'
Column - PVC, Tapered, Recessed Square Edge Panel, 13"-9" @ 5'
Column - PVC, Tapered, Recessed Square Edge Panel, 13"-9" @ 6'
Column - PVC, Tapered, Recessed Square Edge Panel, 13"-9" @ 8'
Column - PVC, Tapered, Recessed Square Edge Panel, 13"-9" @ 10'
Column - PVC, Tapered, Recessed Square Edge Panel, 13"-9" @ 12'

\$ 230.33	\$ 216.51
\$ 259.65	\$ 244.07
\$ 288.97	\$ 271.63
\$ 347.60	\$ 326.75
\$ 406.25	\$ 381.87
\$ 464.98	\$ 437.08

16" - 12" TAPERED COLUMNS

CPTRS-1612048
CPTRS-1612060
CPTRS-1612072
CPTRS-1612096
CPTRS-1612120
CPTRS-1612144

CPTRS-1612048-4K
CPTRS-1612060-4K
CPTRS-1612072-4K
CPTRS-1612096-4K
CPTRS-1612120-4K
CPTRS-1612144-4K

Column - PVC, Tapered, Recessed Square Edge Panel, 16"-12" @ 4'
Column - PVC, Tapered, Recessed Square Edge Panel, 16"-12" @ 5'
Column - PVC, Tapered, Recessed Square Edge Panel, 16"-12" @ 6'
Column - PVC, Tapered, Recessed Square Edge Panel, 16"-12" @ 8'
Column - PVC, Tapered, Recessed Square Edge Panel, 16"-12" @ 10'
Column - PVC, Tapered, Recessed Square Edge Panel, 16"-12" @ 12'

\$ 262.66	\$ 246.90
\$ 300.49	\$ 282.46
\$ 338.32	\$ 318.02
\$ 413.99	\$ 389.15
\$ 489.65	\$ 460.27
\$ 565.43	\$ 531.50

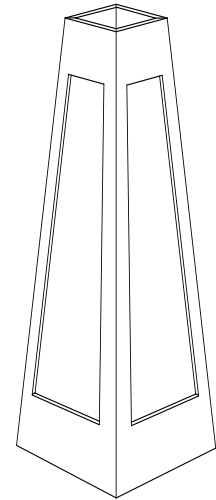

T
A
P
E
R
E
D

R
E
C
E
S
S
E
D

S
Q
U
A
R
E

E
D
G
E

*12% FOR CUSTOM HEIGHT
**PRICES SUBJECT TO CHANGE WITHOUT NOTICE

DIMS

OUTSIDE		INSIDE	
TOP	BOTTOM	TOP	BOTTOM
6"	9"	5"	8"
8"	12"	7"	11"
9"	13"	8"	12"
12"	16"	11"	15"

SQUARING "L" INCLUDED

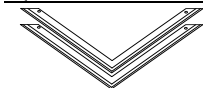

*Adds 3" to Outside Dims



PRICE LEVEL	
STOCKING	
Standard C&B: 4" Craftsman	
CAP	4" Craftsman Skirt Set
BASE	4" Craftsman Skirt Set
<input checked="" type="checkbox"/> ADD CAP & BASE	

PRESTIGE COLUMNS - 2017

12" - 8" TAPERED COLUMNS

PRODUCT CODE / SHAFT ONLY
CPTRBF-1208048
CPTRBF-1208060
CPTRBF-1208072
CPTRBF-1208096
CPTRBF-1208120
CPTRBF-1208144

PRODUCT CODE
CPTRBF-1208048-4K
CPTRBF-1208060-4K
CPTRBF-1208072-4K
CPTRBF-1208096-4K
CPTRBF-1208120-4K
CPTRBF-1208144-4K

DESCRIPTION
Column - PVC, Tapered, Recessed Flush Trim Panel, 12"-8" @ 4'
Column - PVC, Tapered, Recessed Flush Trim Panel, 12"-8" @ 5'
Column - PVC, Tapered, Recessed Flush Trim Panel, 12"-8" @ 6'
Column - PVC, Tapered, Recessed Flush Trim Panel, 12"-8" @ 8'
Column - PVC, Tapered, Recessed Flush Trim Panel, 12"-8" @ 10'
Column - PVC, Tapered, Recessed Flush Trim Panel, 12"-8" @ 12'

	1 PIECE	6 PIECE
\$	261.40	\$ 245.72
\$	287.51	\$ 270.26
\$	313.61	\$ 294.80
\$	365.84	\$ 343.89
\$	418.06	\$ 392.98
\$	470.36	\$ 442.14

13" - 9" TAPERED COLUMNS

CPTRBF-1309048
CPTRBF-1309060
CPTRBF-1309072
CPTRBF-1309096
CPTRBF-1309120
CPTRBF-1309144

CPTRBF-1309048-4K
CPTRBF-1309060-4K
CPTRBF-1309072-4K
CPTRBF-1309096-4K
CPTRBF-1309120-4K
CPTRBF-1309144-4K

Column - PVC, Tapered, Recessed Flush Trim Panel, 13"-9" @ 4'
Column - PVC, Tapered, Recessed Flush Trim Panel, 13"-9" @ 5'
Column - PVC, Tapered, Recessed Flush Trim Panel, 13"-9" @ 6'
Column - PVC, Tapered, Recessed Flush Trim Panel, 13"-9" @ 8'
Column - PVC, Tapered, Recessed Flush Trim Panel, 13"-9" @ 10'
Column - PVC, Tapered, Recessed Flush Trim Panel, 13"-9" @ 12'

\$	271.21	\$ 254.94
\$	298.92	\$ 280.98
\$	326.63	\$ 307.03
\$	382.03	\$ 359.11
\$	437.45	\$ 411.20
\$	492.96	\$ 463.38

16" - 12" TAPERED COLUMNS

CPTRBF-1612048
CPTRBF-1612060
CPTRBF-1612072
CPTRBF-1612096
CPTRBF-1612120
CPTRBF-1612144

CPTRBF-1612048-4K
CPTRBF-1612060-4K
CPTRBF-1612072-4K
CPTRBF-1612096-4K
CPTRBF-1612120-4K
CPTRBF-1612144-4K

Column - PVC, Tapered, Recessed Flush Trim Panel, 16"-12" @ 4'
Column - PVC, Tapered, Recessed Flush Trim Panel, 16"-12" @ 5'
Column - PVC, Tapered, Recessed Flush Trim Panel, 16"-12" @ 6'
Column - PVC, Tapered, Recessed Flush Trim Panel, 16"-12" @ 8'
Column - PVC, Tapered, Recessed Flush Trim Panel, 16"-12" @ 10'
Column - PVC, Tapered, Recessed Flush Trim Panel, 16"-12" @ 12'

\$	296.68	\$ 278.88
\$	329.17	\$ 309.42
\$	361.66	\$ 339.96
\$	426.65	\$ 401.05
\$	491.64	\$ 462.14
\$	556.75	\$ 523.34

*12% FOR CUSTOM HEIGHT
 **PRICES SUBJECT TO CHANGE WITHOUT NOTICE

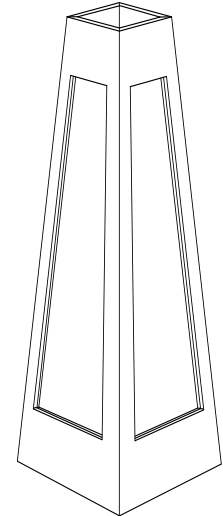

T
A
P
E
R
E
D

R
E
C
E
S
S
E
D

F
L
U
S
H

T
R
I
M

DIMS			
OUTSIDE		INSIDE	
TOP	BOTTOM	TOP	BOTTOM
8"	12"	7"	11"
9"	13"	8"	12"
12"	16"	11"	15"

SQUARING "L" INCLUDED



*Adds 3" to Outside Dims



PRESTIGE COLUMNS

T
A
P
E
R
E
D

C
A
P

&

B
A
S
E

O
P
T
I
O
N
S

	PRODUCT CODE	DESCRIPTION	STANDARD PACKAGE
<u>9" - 6" TAPERED COLUMNS</u>	CSP3C14T	Skirt-PVC,CMN-9"-6"Col-4" SET	\$ 16.18
	CSP3C16T	Skirt-PVC,CMN-9"-6"Col-6" SET	\$ 24.97
	CSP3C18T	Skirt-PVC,CMN-9"-6"Col-8" SET	\$ 29.10
	CSP5C1T	Skirt-PVC,SLD CRWN-9"-6"Col SET	\$ 36.18
<u>12" - 8" TAPERED COLUMNS</u>	CSP3424T	Skirt-PVC,CMN-12"-8"Col-4" SET	\$ 18.61
	CSP3426T	Skirt-PVC,CMN-12"-8"Col-6" SET	\$ 28.68
	CSP3428T	Skirt-PVC,CMN-12"-8"Col-8" SET	\$ 34.00
	CSP542T	Skirt-PVC,SLD CRWN-12"-8"Col SET	\$ 40.80
<u>13" - 9" TAPERED COLUMNS</u>	CSP3DC4T	Skirt-PVC,CMN-13"-9"Col-4" SET	\$ 19.55
	CSP3DC6T	Skirt-PVC,CMN-13"-9"Col-6" SET	\$ 30.17
	CSP3DC28T	Skirt-PVC,CMN-13"-9"Col-8" SET	\$ 35.94
	CSP5DCT	Skirt-PVC,SLD CRWN-13"-9"Col SET	\$ 42.64
<u>16" - 12" TAPERED COLUMNS</u>	CSP3644T	Skirt-PVC,CMN-16"-12"Col-4" SET	\$ 22.49
	CSP3646T	Skirt-PVC,CMN-16"-12"Col-6" SET	\$ 31.02
	CSP3648T	Skirt-PVC,CMN-16"-12"Col-8" SET	\$ 38.50
	CSP564T	Skirt-PVC,SLD CRWN-16"-12"Col SET	\$ 45.04

****PRICES SUBJECT TO CHANGE WITHOUT NOTICE**



Innovative PVC Systems

P R E M I U M C O L U M N S T Y L E S



Columns shown above are Edgewater I.

The Prestige Advantage™

Beautiful

- Classic Architectural Look
- No Visible Fasteners
- Wide Assortment of Styles

Easy Installation

- Complete Kit, with Fasteners & Adhesive
- No Special Tools Needed
- Easy Innovative SmartLock™ Corners
- Flat-Pack for Safe & Easy Transportation

Virtually Maintenance Free

- Free-Foam Cellular PVC Construction
- Weather, Decay and Insect Resistant
- Paint Friendly with Acrylic Latex Paints

Smart & Beautiful

Prestige Columns™ feature beautiful, unblemished column panel faces. Each panel incorporates our innovative SmartLock™ Corner technology, resulting in a column that is assembled without the need for nails or screws marring the panel face.

The PREMIUM COLUMN SERIES™ reflects style of elegance that has been produced over the years for architects and builders as repeat custom profiles that have earned their place in the series.





Innovative PVC Systems

P R E M I U M C O L U M N S T Y L E S



Cochren Flare I

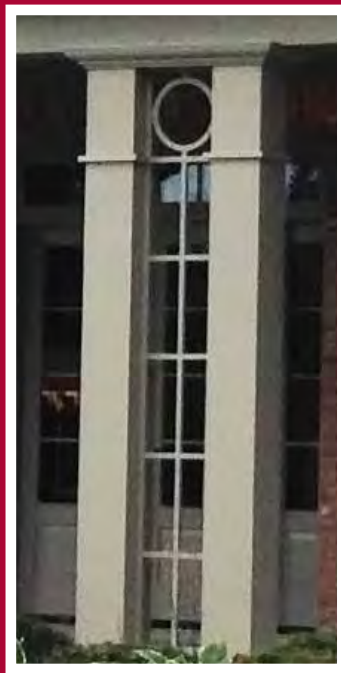

Cochren Flare II

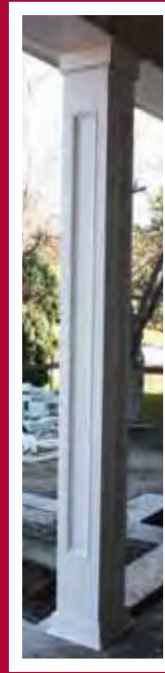

Bayside I



Bayview I

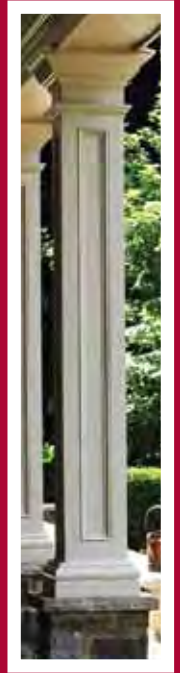

Edgewater I



Riverside I

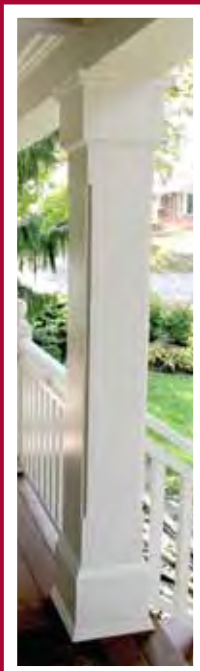

Unique Flare I

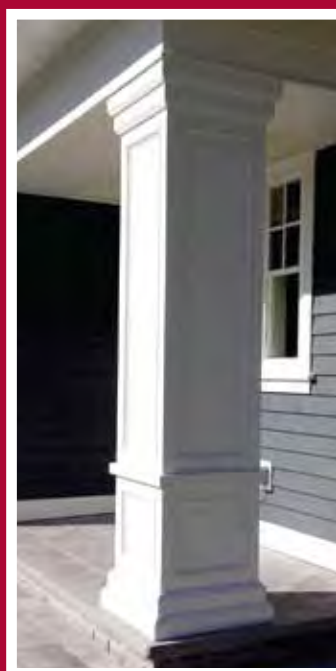

Blue Water I



Lakeside I



Bayshore II



PRESTIGE PREMIUM

PRESTIGE PREMIUM COLUMNS - 2017

PRICE LEVEL
STOCKING



	PRODUCT CODE	DESCRIPTION	STANDARD PACKAGE
BAYSHORE II	CPSRS2-08096	Column - PVC, Square Edge, Double Recessed Panel, 8" @ 8' /w 4" Craftsman Cap & 8" Craftsman Base	\$ 249.71
	CPSRS2-10096	Column - PVC, Square Edge, Double Recessed Panel, 10" @ 8' /w 4" Craftsman Cap & 8" Craftsman Base	\$ 298.74
	CPSRS2-12120	Column - PVC, Square Edge, Double Recessed Panel, 12" @ 10' /w 4" Craftsman Skirt & 8" Craftsman Base	\$ 394.57
LAKESIDE I	CPSRBF4-08096	Column - PVC, Square, Recessed Flush Trim Panel - 50/50, 8" @ 8' /w 4" Craftsman Skirts	\$ 336.66
	CPSRBF4-10096	Column - PVC, Square, Recessed Flush Trim Panel - 50/50, 10" @ 8' /w 4" Craftsman Skirts	\$ 373.71
	CPSRBF4-12120	Column - PVC, Square, Recessed Flush Trim Panel - 50/50, 12" @ 10' /w 4" Craftsman Skirts	\$ 478.80
BAYSIDE I	CPSRBF1-08096	Column - PVC, Square, Recessed Flush Trim Single Panel, 8" @ 8' /w 4" Craftsman Skirts	\$ 308.55
	CPSRBF1-10096	Column - PVC, Square, Recessed Flush Trim Single Panel, 10" @ 8' /w 4" Craftsman Skirts	\$ 342.47
	CPSRBF1-12120	Column - PVC, Square, Recessed Flush Trim Single Panel, 12" @ 10' /w 4" Craftsman Skirts	\$ 438.24
RIVERSIDE I	CPSRBF3-08096	Column - PVC, Square, Recessed Flush Trim Panel - 1/2 - 2/3, 8" @ 8' /w 5" Crown Cap, 8" Base Cap Skirt & Base Cap Astragal	\$ 401.87
	CPSRBF3-10096	Column - PVC, Square, Recessed Flush Trim Panel - 1/2 - 2/3, 10" @ 8' /w 5" Crown Cap, 8" Base Cap Skirt & Base Cap Astragal	\$ 447.22
	CPSRBF3-12120	Column - PVC, Square, Recessed Flush Trim Panel - 1/2 - 2/3, 12" @ 10' /w 5" Crown Cap, 8" Base Cap Skirt & Base Cap Astragal	\$ 560.62
EDGEWATER I	CPSRBF1-08096	Column - PVC, Square, Recessed Flush Trim Single Panel, 8" @ 8' /w 6" Crown Cap, 6" PVC Tuscan Skirt & Base Cap Astragal	\$ 359.52
	CPSRBF1-10096	Column - PVC, Square, Recessed Flush Trim Single Panel, 10" @ 8' /w 6" Crown Cap, 6" PVC Tuscan Skirt & Base Cap Astragal	\$ 396.53
	CPSRBF1-12120	Column - PVC, Square, Recessed Flush Trim Single Panel, 12" @ 10' /w 6" Crown Cap, 6" PVC Tuscan Skirt & Base Cap Astragal	\$ 495.43
BAYVIEW I	CPSRBF1-08096	Column - PVC, Square, Recessed Flush Trim Single Panel, 8" @ 8' /w 5" Crown Cap, 8" Base Cap Skirt & Base Cap Astragal	\$ 373.76
	CPSRBF1-10096	Column - PVC, Square, Recessed Flush Trim Single Panel, 10" @ 8' /w 5" Crown Cap, 8" Base Cap Skirt & Base Cap Astragal	\$ 415.98
	CPSRBF1-12120	Column - PVC, Square, Recessed Flush Trim Single Panel, 12" @ 10' /w 5" Crown Cap, 8" Base Cap Skirt & Base Cap Astragal	\$ 520.06
COCHREN FLARE I	CPSPLDC12-08096	Column - PVC, Square, Plain Panel /w Double 12" Lattice, 8" @ 8' /w 5" Crown Mould Cap, 6" PVC Tuscan Base & 1" Astragal	\$ 910.89
	CPSPLDC12-10096	Column - PVC, Square, Plain Panel /w Double 12" Lattice, 10" @ 8' /w 5" Crown Mould Cap, 6" PVC Tuscan Base & 1" Astragal	\$ 997.69
	CPSPLDC12-12120	Column - PVC, Square, Plain Panel /w Double 12" Lattice, 12" @ 10' /w 5" Crown Mould Cap, 6" PVC Tuscan Base & 1" Astragal	\$ 1,285.87
COCHREN FLARE II	CPSPLS12-08096	Column - PVC, Square, Plain Panel /w Single 12" Lattice, 8" @ 8' /w 5" Crown Mould Cap, 6" PVC Tuscan Base & 1" Astragal	\$ 552.85
	CPSPLS12-10096	Column - PVC, Square, Plain Panel /w Single 12" Lattice, 10" @ 8' /w 5" Crown Mould Cap, 6" PVC Tuscan Base & 1" Astragal	\$ 615.19
	CPSPLS12-12120	Column - PVC, Square, Plain Panel /w Single 12" Lattice, 12" @ 10' /w 5" Crown Mould Cap, 6" PVC Tuscan Base & 1" Astragal	\$ 789.96
UNIQUE FLARE	CPSCH-08096	Column - PVC, Square, Chamfered Plain Panel, 8" @ 8' /w 4/4" x 8" Chamfered Cap & 4/4" x 10" Chamfered Base	\$ 285.66
	CPSCH-10096	Column - PVC, Square, Chamfered Plain Panel, 10" @ 8' /w 4/4" x 8" Chamfered Cap & 4/4" x 10" Chamfered Base	\$ 346.51
	CPSCH-12120	Column - PVC, Square, Chamfered Plain Panel, 12" @ 10' /w 4/4" x 8" Chamfered Cap & 4/4" x 10" Chamfered Base	\$ 486.01

DIMS

SIZE	OUTSIDE
6"	5-1/2"
8"	7-1/4"
10"	9-3/8"
12"	11-1/2"
14"	13-1/4"

SQUARING "L" INCLUDED



*Adds 3" to Outside Dims

***12% FOR CUSTOM HEIGHT & 12% FOR ACTUAL WIDTH**
*****FOR COLUMNS LARGER THAN 14" PLEASE CONTACT YOUR LOCAL PRESTIGE DEALER**
****PRICES SUBJECT TO CHANGE WITHOUT NOTICE**



PRESTIGE COLUMNS - 2017



PRICE LEVEL	
STOCKING	
Standard C&B: Chamfered 8" CP & 10 BSE	
CAP	8" Chamfered (4/4")
BASE	10" Chamfered (4/4")
<input checked="" type="checkbox"/> ADD CAP & BASE	

8" COLUMNS

PRODUCT CODE	DESCRIPTION
CPSCH-08048	Column - PVC, Square, Chamfered Plain Panel, 8" @ 4'
CPSCH-08060	Column - PVC, Square, Chamfered Plain Panel, 8" @ 5'
CPSCH-08072	Column - PVC, Square, Chamfered Plain Panel, 8" @ 6'
CPSCH-08096	Column - PVC, Square, Chamfered Plain Panel, 8" @ 8'
CPSCH-08108	Column - PVC, Square, Chamfered Plain Panel, 8" @ 9'
CPSCH-08120	Column - PVC, Square, Chamfered Plain Panel, 8" @ 10'
CPSCH-08144	Column - PVC, Square, Chamfered Plain Panel, 8" @ 12'

1 PIECE	6 PIECE
\$ 217.84	\$ 204.77
\$ 249.29	\$ 234.33
\$ 280.74	\$ 263.90
\$ 343.64	\$ 323.02
\$ 375.10	\$ 352.59
\$ 406.55	\$ 382.15
\$ 469.45	\$ 441.28

10" COLUMNS

CPSCH-10048	Column - PVC, Square, Chamfered Plain Panel, 10" @ 4'
CPSCH-10060	Column - PVC, Square, Chamfered Plain Panel, 10" @ 5'
CPSCH-10072	Column - PVC, Square, Chamfered Plain Panel, 10" @ 6'
CPSCH-10096	Column - PVC, Square, Chamfered Plain Panel, 10" @ 8'
CPSCH-10108	Column - PVC, Square, Chamfered Plain Panel, 10" @ 9'
CPSCH-10120	Column - PVC, Square, Chamfered Plain Panel, 10" @ 10'
CPSCH-10144	Column - PVC, Square, Chamfered Plain Panel, 10" @ 12'

\$ 259.39	\$ 243.83
\$ 298.71	\$ 280.79
\$ 338.03	\$ 317.75
\$ 416.67	\$ 391.67
\$ 455.99	\$ 428.63
\$ 495.31	\$ 465.59
\$ 573.95	\$ 539.51

12" COLUMNS

CPSCH-12048	Column - PVC, Square, Chamfered Plain Panel, 12" @ 4'
CPSCH-12060	Column - PVC, Square, Chamfered Plain Panel, 12" @ 5'
CPSCH-12072	Column - PVC, Square, Chamfered Plain Panel, 12" @ 6'
CPSCH-12096	Column - PVC, Square, Chamfered Plain Panel, 12" @ 8'
CPSCH-12108	Column - PVC, Square, Chamfered Plain Panel, 12" @ 9'
CPSCH-12120	Column - PVC, Square, Chamfered Plain Panel, 12" @ 10'
CPSCH-12144	Column - PVC, Square, Chamfered Plain Panel, 12" @ 12'

\$ 300.93	\$ 282.87
\$ 348.12	\$ 327.23
\$ 395.31	\$ 371.59
\$ 489.69	\$ 460.31
\$ 536.87	\$ 504.66
\$ 584.07	\$ 549.02
\$ 678.45	\$ 637.74

14" COLUMNS

CPSCH-14048	Column - PVC, Square, Chamfered Plain Panel, 14" @ 4'
CPSCH-14060	Column - PVC, Square, Chamfered Plain Panel, 14" @ 5'
CPSCH-14072	Column - PVC, Square, Chamfered Plain Panel, 14" @ 6'
CPSCH-14096	Column - PVC, Square, Chamfered Plain Panel, 14" @ 8'
CPSCH-14108	Column - PVC, Square, Chamfered Plain Panel, 14" @ 9'
CPSCH-14120	Column - PVC, Square, Chamfered Plain Panel, 14" @ 10'
CPSCH-14144	Column - PVC, Square, Chamfered Plain Panel, 14" @ 12'

\$ 369.94	\$ 347.74
\$ 394.74	\$ 371.05
\$ 449.79	\$ 422.81
\$ 559.89	\$ 526.29
\$ 614.94	\$ 578.05
\$ 669.99	\$ 629.79
\$ 780.09	\$ 733.28

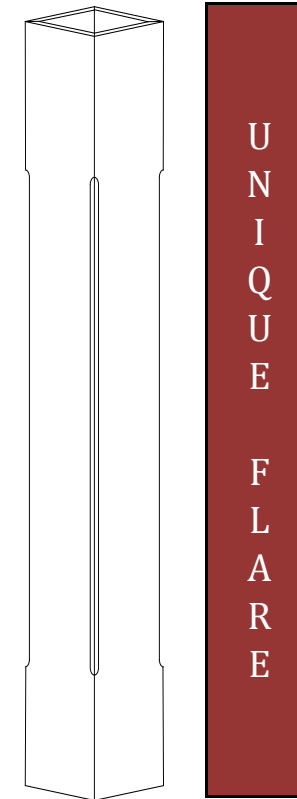

*12% FOR CUSTOM HEIGHT & 12% FOR ACTUAL WIDTH
 ***FOR COLUMNS LARGER THAN 14" PLEASE CONTACT YOUR LOCAL PRESTIGE DEALER
 **PRICES SUBJECT TO CHANGE WITHOUT NOTICE

SIZE	OUTSIDE DIMS	INSIDE
6"	5-1/2"	3-1/2"
8"	7-1/4"	5-1/4"
10"	9-3/8"	7-3/8"
12"	11-1/2"	9-1/2"
14"	13-1/4"	11-1/4"

SQUARING "L" INCLUDED



*Adds 3" to Outside Dims



PRESTIGE COLUMNS - 2017



PRICE LEVEL	
STOCKING	
Standard C&B: 5" CRWN CP & 6" TSCN BSE	
CAP	5" Crown Mould
BASE	PVC Tuscan 6"
<input checked="" type="checkbox"/> ADD CAP & BASE	

8" COLUMNS

PRODUCT CODE
CPSPLS12-08048
CPSPLS12-08060
CPSPLS12-08072
CPSPLS12-08096
CPSPLS12-08108
CPSPLS12-08120
CPSPLS12-08144

DESCRIPTION
Column - PVC, Square, Plain Panel /w Single 12" Lattice, 8" @ 4'
Column - PVC, Square, Plain Panel /w Single 12" Lattice, 8" @ 5'
Column - PVC, Square, Plain Panel /w Single 12" Lattice, 8" @ 6'
Column - PVC, Square, Plain Panel /w Single 12" Lattice, 8" @ 8'
Column - PVC, Square, Plain Panel /w Single 12" Lattice, 8" @ 9'
Column - PVC, Square, Plain Panel /w Single 12" Lattice, 8" @ 10'
Column - PVC, Square, Plain Panel /w Single 12" Lattice, 8" @ 12'

1 PIECE		6 PIECE	
\$	440.37	\$	413.95
\$	503.90	\$	473.67
\$	546.12	\$	513.35
\$	651.87	\$	612.76
\$	704.36	\$	662.10
\$	757.62	\$	712.16
\$	863.53	\$	811.72

10" COLUMNS

CPSPLS12-10048
CPSPLS12-10060
CPSPLS12-10072
CPSPLS12-10096
CPSPLS12-10108
CPSPLS12-10120
CPSPLS12-10144

Column - PVC, Square, Plain Panel /w Single 12" Lattice, 10" @ 4'
Column - PVC, Square, Plain Panel /w Single 12" Lattice, 10" @ 5'
Column - PVC, Square, Plain Panel /w Single 12" Lattice, 10" @ 6'
Column - PVC, Square, Plain Panel /w Single 12" Lattice, 10" @ 8'
Column - PVC, Square, Plain Panel /w Single 12" Lattice, 10" @ 9'
Column - PVC, Square, Plain Panel /w Single 12" Lattice, 10" @ 10'
Column - PVC, Square, Plain Panel /w Single 12" Lattice, 10" @ 12'

\$	479.08	\$	450.34
\$	550.51	\$	517.48
\$	600.60	\$	564.57
\$	722.13	\$	678.80
\$	782.88	\$	735.91
\$	843.64	\$	793.03
\$	965.37	\$	907.45

12" COLUMNS

CPSPLS12-12048
CPSPLS12-12060
CPSPLS12-12072
CPSPLS12-12096
CPSPLS12-12108
CPSPLS12-12120
CPSPLS12-12144

Column - PVC, Square, Plain Panel /w Single 12" Lattice, 12" @ 4'
Column - PVC, Square, Plain Panel /w Single 12" Lattice, 12" @ 5'
Column - PVC, Square, Plain Panel /w Single 12" Lattice, 12" @ 6'
Column - PVC, Square, Plain Panel /w Single 12" Lattice, 12" @ 8'
Column - PVC, Square, Plain Panel /w Single 12" Lattice, 12" @ 9'
Column - PVC, Square, Plain Panel /w Single 12" Lattice, 12" @ 10'
Column - PVC, Square, Plain Panel /w Single 12" Lattice, 12" @ 12'

\$	517.76	\$	486.69
\$	597.08	\$	561.25
\$	655.06	\$	615.75
\$	792.35	\$	744.81
\$	861.00	\$	809.34
\$	929.64	\$	873.87
\$	1,067.18	\$	1,003.15

***12% FOR CUSTOM HEIGHT & 12% FOR ACTUAL WIDTH**
*****FOR COLUMNS LARGER THAN 14" PLEASE CONTACT YOUR LOCAL PRESTIGE DEALER**
****PRICES SUBJECT TO CHANGE WITHOUT NOTICE**

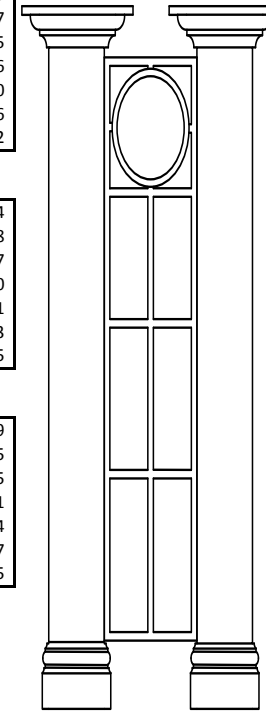

COCHRAN FLARE

SQUARING "L" INCLUDED



***Adds 3" to Outside Dims**

DIMS		
SIZE	OUTSIDE	INSIDE
6"	5-1/2"	4-1/2"
8"	7-1/4"	6-1/4"
10"	9-3/8"	8-3/8"
12"	11-1/2"	10-1/2"
14"	13-1/4"	12-1/4"



PRESTIGE COLUMNS - 2017



PRICE LEVEL	
STOCKING	
Standard C&B: 5" CRWN CP & 6" TSCN BSE	
CAP	5" Crown Mould
BASE	PVC Tuscan 6"
<input checked="" type="checkbox"/> ADD CAP & BASE	

	PRODUCT CODE	DESCRIPTION	1 PIECE	6 PIECE
8" COLUMNS	CPSPLS16-08048	Column - PVC, Square, Plain Panel /w Single 16" Lattice, 8" @ 4'	\$ 457.86	\$ 430.38
	CPSPLS16-08060	Column - PVC, Square, Plain Panel /w Single 16" Lattice, 8" @ 5'	\$ 531.89	\$ 499.98
	CPSPLS16-08072	Column - PVC, Square, Plain Panel /w Single 16" Lattice, 8" @ 6'	\$ 577.60	\$ 542.94
	CPSPLS16-08096	Column - PVC, Square, Plain Panel /w Single 16" Lattice, 8" @ 8'	\$ 697.34	\$ 655.50
	CPSPLS16-08108	Column - PVC, Square, Plain Panel /w Single 16" Lattice, 8" @ 9'	\$ 757.57	\$ 712.11
	CPSPLS16-08120	Column - PVC, Square, Plain Panel /w Single 16" Lattice, 8" @ 10'	\$ 817.08	\$ 768.06
	CPSPLS16-08144	Column - PVC, Square, Plain Panel /w Single 16" Lattice, 8" @ 12'	\$ 936.99	\$ 880.77
10" COLUMNS	CPSPLS16-10048	Column - PVC, Square, Plain Panel /w Single 16" Lattice, 10" @ 4'	\$ 496.57	\$ 466.77
	CPSPLS16-10060	Column - PVC, Square, Plain Panel /w Single 16" Lattice, 10" @ 5'	\$ 578.49	\$ 543.78
	CPSPLS16-10072	Column - PVC, Square, Plain Panel /w Single 16" Lattice, 10" @ 6'	\$ 632.08	\$ 594.16
	CPSPLS16-10096	Column - PVC, Square, Plain Panel /w Single 16" Lattice, 10" @ 8'	\$ 767.60	\$ 721.54
	CPSPLS16-10108	Column - PVC, Square, Plain Panel /w Single 16" Lattice, 10" @ 9'	\$ 835.35	\$ 785.23
	CPSPLS16-10120	Column - PVC, Square, Plain Panel /w Single 16" Lattice, 10" @ 10'	\$ 903.11	\$ 848.92
	CPSPLS16-10144	Column - PVC, Square, Plain Panel /w Single 16" Lattice, 10" @ 12'	\$ 1,038.83	\$ 976.50
12" COLUMNS	CPSPLS16-12048	Column - PVC, Square, Plain Panel /w Single 16" Lattice, 12" @ 4'	\$ 535.26	\$ 503.14
	CPSPLS16-12060	Column - PVC, Square, Plain Panel /w Single 16" Lattice, 12" @ 5'	\$ 625.06	\$ 587.55
	CPSPLS16-12072	Column - PVC, Square, Plain Panel /w Single 16" Lattice, 12" @ 6'	\$ 686.54	\$ 645.34
	CPSPLS16-12096	Column - PVC, Square, Plain Panel /w Single 16" Lattice, 12" @ 8'	\$ 837.82	\$ 787.55
	CPSPLS16-12108	Column - PVC, Square, Plain Panel /w Single 16" Lattice, 12" @ 9'	\$ 913.47	\$ 858.66
	CPSPLS16-12120	Column - PVC, Square, Plain Panel /w Single 16" Lattice, 12" @ 10'	\$ 989.11	\$ 929.76
	CPSPLS16-12144	Column - PVC, Square, Plain Panel /w Single 16" Lattice, 12" @ 12'	\$ 1,140.64	\$ 1,072.20

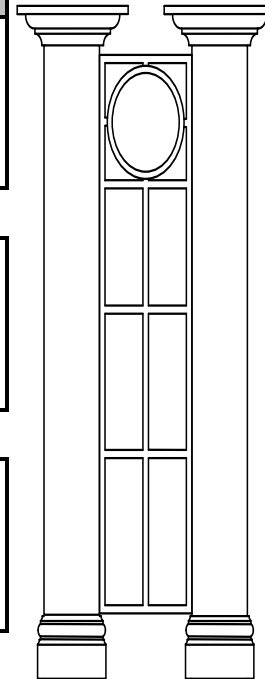

COCHREN FLARE

*12% FOR CUSTOM HEIGHT & 12% FOR ACTUAL WIDTH
 ***FOR COLUMNS LARGER THAN 14" PLEASE CONTACT YOUR LOCAL PRESTIGE DEALER
 **PRICES SUBJECT TO CHANGE WITHOUT NOTICE

SQUARING "L" INCLUDED

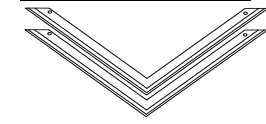

*Adds 3" to Outside Dims

	DIMS	
SIZE	OUTSIDE	INSIDE
6"	5-1/2"	4-1/2"
8"	7-1/4"	6-1/4"
10"	9-3/8"	8-3/8"
12"	11-1/2"	10-1/2"
14"	13-1/4"	12-1/4"



PRICE LEVEL	
STOCKING	
Standard C&B: 5" CRWN CP & 6" TSCN BSE	
CAP	5" Crown Mould
BASE	PVC Tuscan 6"
<input checked="" type="checkbox"/> ADD CAP & BASE	

PRESTIGE COLUMNS - 2017

8" COLUMNS	PRODUCT CODE	DESCRIPTION	1 PIECE	6 PIECE
		CPSPLS24-08048	Column - PVC, Square, Plain Panel /w Single 24" Lattice, 8" @ 4'	\$ 493.41
	CPSPLS24-08060	Column - PVC, Square, Plain Panel /w Single 24" Lattice, 8" @ 5'	\$ 588.77	\$ 553.45
	CPSPLS24-08072	Column - PVC, Square, Plain Panel /w Single 24" Lattice, 8" @ 6'	\$ 641.60	\$ 603.10
	CPSPLS24-08096	Column - PVC, Square, Plain Panel /w Single 24" Lattice, 8" @ 8'	\$ 789.78	\$ 742.40
	CPSPLS24-08108	Column - PVC, Square, Plain Panel /w Single 24" Lattice, 8" @ 9'	\$ 757.57	\$ 712.11
	CPSPLS24-08120	Column - PVC, Square, Plain Panel /w Single 24" Lattice, 8" @ 10'	\$ 937.97	\$ 881.69
	CPSPLS24-08144	Column - PVC, Square, Plain Panel /w Single 24" Lattice, 8" @ 12'	\$ 1,086.31	\$ 1,021.14
10" COLUMNS				
	CPSPLS24-10048	Column - PVC, Square, Plain Panel /w Single 24" Lattice, 10" @ 4'	\$ 532.12	\$ 500.20
	CPSPLS24-10060	Column - PVC, Square, Plain Panel /w Single 24" Lattice, 10" @ 5'	\$ 635.37	\$ 597.25
	CPSPLS24-10072	Column - PVC, Square, Plain Panel /w Single 24" Lattice, 10" @ 6'	\$ 696.08	\$ 654.32
	CPSPLS24-10096	Column - PVC, Square, Plain Panel /w Single 24" Lattice, 10" @ 8'	\$ 860.04	\$ 808.43
	CPSPLS24-10108	Column - PVC, Square, Plain Panel /w Single 24" Lattice, 10" @ 9'	\$ 942.02	\$ 885.50
	CPSPLS24-10120	Column - PVC, Square, Plain Panel /w Single 24" Lattice, 10" @ 10'	\$ 1,023.99	\$ 962.55
	CPSPLS24-10144	Column - PVC, Square, Plain Panel /w Single 24" Lattice, 10" @ 12'	\$ 1,188.16	\$ 1,116.87
12" COLUMNS				
	CPSPLS24-12048	Column - PVC, Square, Plain Panel /w Single 24" Lattice, 12" @ 4'	\$ 570.80	\$ 536.55
	CPSPLS24-12060	Column - PVC, Square, Plain Panel /w Single 24" Lattice, 12" @ 5'	\$ 681.95	\$ 641.03
	CPSPLS24-12072	Column - PVC, Square, Plain Panel /w Single 24" Lattice, 12" @ 6'	\$ 750.54	\$ 705.50
	CPSPLS24-12096	Column - PVC, Square, Plain Panel /w Single 24" Lattice, 12" @ 8'	\$ 930.26	\$ 874.45
	CPSPLS24-12108	Column - PVC, Square, Plain Panel /w Single 24" Lattice, 12" @ 9'	\$ 1,020.13	\$ 958.92
	CPSPLS24-12120	Column - PVC, Square, Plain Panel /w Single 24" Lattice, 12" @ 10'	\$ 1,109.99	\$ 1,043.39
	CPSPLS24-12144	Column - PVC, Square, Plain Panel /w Single 24" Lattice, 12" @ 12'	\$ 1,289.96	\$ 1,212.57

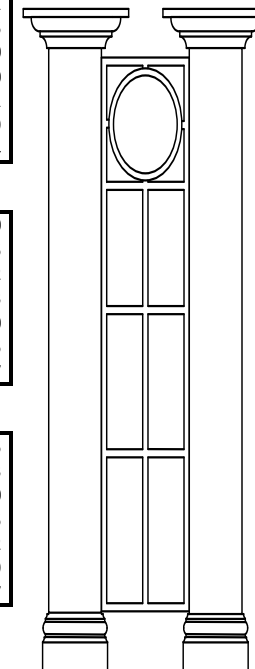

COCHREN FLARE

*12% FOR CUSTOM HEIGHT & 12% FOR ACTUAL WIDTH
 ***FOR COLUMNS LARGER THAN 14" PLEASE CONTACT YOUR LOCAL PRESTIGE DEALER
 **PRICES SUBJECT TO CHANGE WITHOUT NOTICE

SQUARING "L" INCLUDED

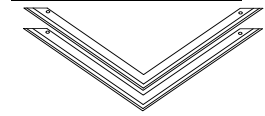

*Adds 3" to Outside Dims

SIZE	DIMS	
	OUTSIDE	INSIDE
6"	5-1/2"	4-1/2"
8"	7-1/4"	6-1/4"
10"	9-3/8"	8-3/8"
12"	11-1/2"	10-1/2"
14"	13-1/4"	12-1/4"



PRESTIGE COLUMNS - 2017



PRICE LEVEL	
STOCKING	
Standard C&B: 5" CRWN CP & 6" TSCN BSE	
CAP	5" Crown Mould
BASE	PVC Tuscan 6"
<input checked="" type="checkbox"/> ADD CAP & BASE	

8" COLUMNS

PRODUCT CODE
CPSPLD12-08048
CPSPLD12-08060
CPSPLD12-08072
CPSPLD12-08096
CPSPLD12-08108
CPSPLD12-08120
CPSPLD12-08144

DESCRIPTION
Column - PVC, Square, Plain Panel /w Double 12" Lattice, 8" @ 4'
Column - PVC, Square, Plain Panel /w Double 12" Lattice, 8" @ 5'
Column - PVC, Square, Plain Panel /w Double 12" Lattice, 8" @ 6'
Column - PVC, Square, Plain Panel /w Double 12" Lattice, 8" @ 8'
Column - PVC, Square, Plain Panel /w Double 12" Lattice, 8" @ 9'
Column - PVC, Square, Plain Panel /w Double 12" Lattice, 8" @ 10'
Column - PVC, Square, Plain Panel /w Double 12" Lattice, 8" @ 12'

1 PIECE		6 PIECE	
\$	618.40	\$	581.30
\$	737.59	\$	693.33
\$	805.73	\$	757.39
\$	993.07	\$	933.48
\$	1,087.37	\$	1,022.13
\$	1,180.41	\$	1,109.58
\$	1,367.96	\$	1,285.88

10" COLUMNS

CPSPLD12-10048
CPSPLD12-10060
CPSPLD12-10072
CPSPLD12-10096
CPSPLD12-10108
CPSPLD12-10120
CPSPLD12-10144

Column - PVC, Square, Plain Panel /w Double 12" Lattice, 10" @ 4'
Column - PVC, Square, Plain Panel /w Double 12" Lattice, 10" @ 5'
Column - PVC, Square, Plain Panel /w Double 12" Lattice, 10" @ 6'
Column - PVC, Square, Plain Panel /w Double 12" Lattice, 10" @ 8'
Column - PVC, Square, Plain Panel /w Double 12" Lattice, 10" @ 9'
Column - PVC, Square, Plain Panel /w Double 12" Lattice, 10" @ 10'
Column - PVC, Square, Plain Panel /w Double 12" Lattice, 10" @ 12'

\$	668.19	\$	628.10
\$	798.04	\$	750.16
\$	876.84	\$	824.23
\$	1,085.50	\$	1,020.37
\$	1,189.82	\$	1,118.43
\$	1,294.14	\$	1,216.49
\$	1,503.06	\$	1,412.88

12" COLUMNS

CPSPLD12-12048
CPSPLD12-12060
CPSPLD12-12072
CPSPLD12-12096
CPSPLD12-12108
CPSPLD12-12120
CPSPLD12-12144

Column - PVC, Square, Plain Panel /w Double 12" Lattice, 12" @ 4'
Column - PVC, Square, Plain Panel /w Double 12" Lattice, 12" @ 5'
Column - PVC, Square, Plain Panel /w Double 12" Lattice, 12" @ 6'
Column - PVC, Square, Plain Panel /w Double 12" Lattice, 12" @ 8'
Column - PVC, Square, Plain Panel /w Double 12" Lattice, 12" @ 9'
Column - PVC, Square, Plain Panel /w Double 12" Lattice, 12" @ 10'
Column - PVC, Square, Plain Panel /w Double 12" Lattice, 12" @ 12'

\$	717.96	\$	674.88
\$	858.47	\$	806.96
\$	947.92	\$	891.05
\$	1,177.88	\$	1,107.21
\$	1,292.87	\$	1,215.29
\$	1,407.84	\$	1,323.37
\$	1,638.14	\$	1,539.85

*12% FOR CUSTOM HEIGHT & 12% FOR ACTUAL WIDTH
 ***FOR COLUMNS LARGER THAN 14" PLEASE CONTACT YOUR LOCAL PRESTIGE DEALER
 **PRICES SUBJECT TO CHANGE WITHOUT NOTICE

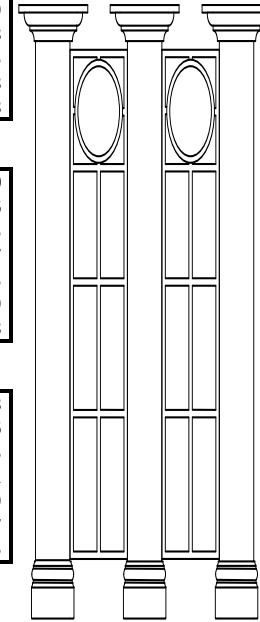

COCHRAN FLARE

SQUARING "L" INCLUDED

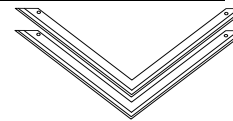

*Adds 3" to Outside Dims

DIMS		
SIZE	OUTSIDE	INSIDE
6"	5-1/2"	4-1/2"
8"	7-1/4"	6-1/4"
10"	9-3/8"	8-3/8"
12"	11-1/2"	10-1/2"
14"	13-1/4"	12-1/4"



PRICE LEVEL	
STOCKING	
Standard C&B: 5" CRWN CP & 6" TSCN BSE	
CAP	5" Crown Mould
BASE	PVC Tuscan 6"
<input checked="" type="checkbox"/> ADD CAP & BASE	

PRESTIGE COLUMNS - 2017

	PRODUCT CODE	DESCRIPTION	1 PIECE	6 PIECE
8" COLUMNS	CPSPLD16-08048	Column - PVC, Square, Plain Panel /w Double 16" Lattice, 8" @ 4'	\$ 618.40	\$ 581.30
	CPSPLD16-08060	Column - PVC, Square, Plain Panel /w Double 16" Lattice, 8" @ 5'	\$ 737.59	\$ 693.33
	CPSPLD16-08072	Column - PVC, Square, Plain Panel /w Double 16" Lattice, 8" @ 6'	\$ 805.73	\$ 757.39
	CPSPLD16-08096	Column - PVC, Square, Plain Panel /w Double 16" Lattice, 8" @ 8'	\$ 993.07	\$ 933.48
	CPSPLD16-08108	Column - PVC, Square, Plain Panel /w Double 16" Lattice, 8" @ 9'	\$ 1,087.37	\$ 1,022.13
	CPSPLD16-08120	Column - PVC, Square, Plain Panel /w Double 16" Lattice, 8" @ 10'	\$ 1,180.41	\$ 1,109.58
	CPSPLD16-08144	Column - PVC, Square, Plain Panel /w Double 16" Lattice, 8" @ 12'	\$ 1,367.96	\$ 1,285.88
10" COLUMNS	CPSPLD16-10048	Column - PVC, Square, Plain Panel /w Double 16" Lattice, 10" @ 4'	\$ 668.19	\$ 628.10
	CPSPLD16-10060	Column - PVC, Square, Plain Panel /w Double 16" Lattice, 10" @ 5'	\$ 798.04	\$ 750.16
	CPSPLD16-10072	Column - PVC, Square, Plain Panel /w Double 16" Lattice, 10" @ 6'	\$ 876.84	\$ 824.23
	CPSPLD16-10096	Column - PVC, Square, Plain Panel /w Double 16" Lattice, 10" @ 8'	\$ 1,085.50	\$ 1,020.37
	CPSPLD16-10108	Column - PVC, Square, Plain Panel /w Double 16" Lattice, 10" @ 9'	\$ 1,189.82	\$ 1,118.43
	CPSPLD16-10120	Column - PVC, Square, Plain Panel /w Double 16" Lattice, 10" @ 10'	\$ 1,294.14	\$ 1,216.49
	CPSPLD16-10144	Column - PVC, Square, Plain Panel /w Double 16" Lattice, 10" @ 12'	\$ 1,503.06	\$ 1,412.88
12" COLUMNS	CPSPLD16-12048	Column - PVC, Square, Plain Panel /w Double 16" Lattice, 12" @ 4'	\$ 717.96	\$ 674.88
	CPSPLD16-12060	Column - PVC, Square, Plain Panel /w Double 16" Lattice, 12" @ 5'	\$ 858.47	\$ 806.96
	CPSPLD16-12072	Column - PVC, Square, Plain Panel /w Double 16" Lattice, 12" @ 6'	\$ 947.92	\$ 891.05
	CPSPLD16-12096	Column - PVC, Square, Plain Panel /w Double 16" Lattice, 12" @ 8'	\$ 1,177.88	\$ 1,107.21
	CPSPLD16-12108	Column - PVC, Square, Plain Panel /w Double 16" Lattice, 12" @ 9'	\$ 1,292.87	\$ 1,215.29
	CPSPLD16-12120	Column - PVC, Square, Plain Panel /w Double 16" Lattice, 12" @ 10'	\$ 1,407.84	\$ 1,323.37
	CPSPLD16-12144	Column - PVC, Square, Plain Panel /w Double 16" Lattice, 12" @ 12'	\$ 1,638.14	\$ 1,539.85

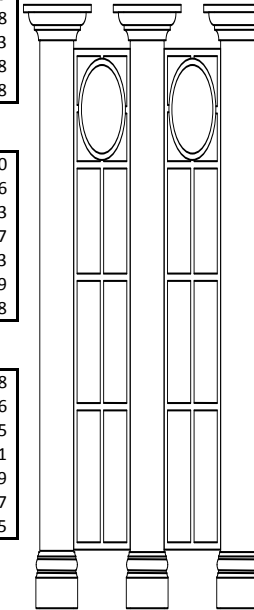

COCHREN FLARE

*12% FOR CUSTOM HEIGHT & 12% FOR ACTUAL WIDTH
 ***FOR COLUMNS LARGER THAN 14" PLEASE CONTACT YOUR LOCAL PRESTIGE DEALER
 **PRICES SUBJECT TO CHANGE WITHOUT NOTICE

SQUARING "L" INCLUDED

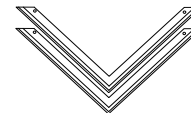

*Adds 3" to Outside Dims

SIZE	DIMS	
	OUTSIDE	INSIDE
6"	5-1/2"	4-1/2"
8"	7-1/4"	6-1/4"
10"	9-3/8"	8-3/8"
12"	11-1/2"	10-1/2"
14"	13-1/4"	12-1/4"



PRICE LEVEL	
STOCKING	
Standard C&B: 5" CRWN CP & 6" TSCN BSE	
CAP	5" Crown Mould
BASE	PVC Tuscan 6"
<input checked="" type="checkbox"/> ADD CAP & BASE	

PRESTIGE COLUMNS - 2017

8" COLUMNS

PRODUCT CODE
CPSPLD24-08048
CPSPLD24-08060
CPSPLD24-08072
CPSPLD24-08096
CPSPLD24-08108
CPSPLD24-08120
CPSPLD24-08144

DESCRIPTION
Column - PVC, Square, Plain Panel /w Double 24" Lattice, 8" @ 4'
Column - PVC, Square, Plain Panel /w Double 24" Lattice, 8" @ 5'
Column - PVC, Square, Plain Panel /w Double 24" Lattice, 8" @ 6'
Column - PVC, Square, Plain Panel /w Double 24" Lattice, 8" @ 8'
Column - PVC, Square, Plain Panel /w Double 24" Lattice, 8" @ 9'
Column - PVC, Square, Plain Panel /w Double 24" Lattice, 8" @ 10'
Column - PVC, Square, Plain Panel /w Double 24" Lattice, 8" @ 12'

1 PIECE	6 PIECE
\$ 682.46	\$ 641.51
\$ 840.08	\$ 789.68
\$ 921.04	\$ 865.78
\$ 1,159.63	\$ 1,090.05
\$ 1,087.37	\$ 1,022.13
\$ 1,398.21	\$ 1,314.32
\$ 1,637.01	\$ 1,538.79

10" COLUMNS

CPSPLD24-10048
CPSPLD24-10060
CPSPLD24-10072
CPSPLD24-10096
CPSPLD24-10108
CPSPLD24-10120
CPSPLD24-10144

Column - PVC, Square, Plain Panel /w Double 24" Lattice, 10" @ 4'
Column - PVC, Square, Plain Panel /w Double 24" Lattice, 10" @ 5'
Column - PVC, Square, Plain Panel /w Double 24" Lattice, 10" @ 6'
Column - PVC, Square, Plain Panel /w Double 24" Lattice, 10" @ 8'
Column - PVC, Square, Plain Panel /w Double 24" Lattice, 10" @ 9'
Column - PVC, Square, Plain Panel /w Double 24" Lattice, 10" @ 10'
Column - PVC, Square, Plain Panel /w Double 24" Lattice, 10" @ 12'

\$ 732.26	\$ 688.32
\$ 900.54	\$ 846.50
\$ 992.16	\$ 932.63
\$ 1,252.05	\$ 1,176.93
\$ 1,382.00	\$ 1,299.08
\$ 1,511.95	\$ 1,421.23
\$ 1,772.12	\$ 1,665.79

12" COLUMNS

CPSPLD24-12048
CPSPLD24-12060
CPSPLD24-12072
CPSPLD24-12096
CPSPLD24-12108
CPSPLD24-12120
CPSPLD24-12144

Column - PVC, Square, Plain Panel /w Double 24" Lattice, 12" @ 4'
Column - PVC, Square, Plain Panel /w Double 24" Lattice, 12" @ 5'
Column - PVC, Square, Plain Panel /w Double 24" Lattice, 12" @ 6'
Column - PVC, Square, Plain Panel /w Double 24" Lattice, 12" @ 8'
Column - PVC, Square, Plain Panel /w Double 24" Lattice, 12" @ 9'
Column - PVC, Square, Plain Panel /w Double 24" Lattice, 12" @ 10'
Column - PVC, Square, Plain Panel /w Double 24" Lattice, 12" @ 12'

\$ 782.02	\$ 735.10
\$ 960.96	\$ 903.30
\$ 1,063.23	\$ 999.44
\$ 1,344.44	\$ 1,263.77
\$ 1,485.05	\$ 1,395.95
\$ 1,625.65	\$ 1,528.12
\$ 1,907.19	\$ 1,792.76

*12% FOR CUSTOM HEIGHT & 12% FOR ACTUAL WIDTH

***FOR COLUMNS LARGER THAN 14" PLEASE CONTACT YOUR LOCAL PRESTIGE DEALER

**PRICES SUBJECT TO CHANGE WITHOUT NOTICE

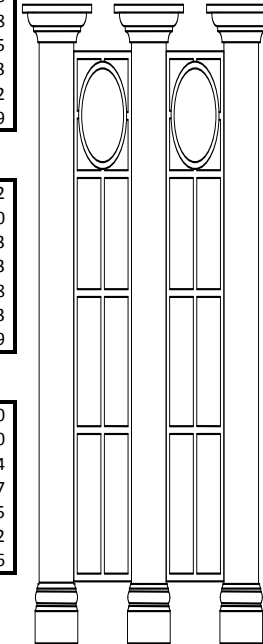

COCHREN FLARE

SQUARING "L" INCLUDED

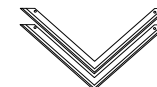

*Adds 3" to Outside Dims

SIZE	DIMS	
	OUTSIDE	INSIDE
6"	5-1/2"	4-1/2"
8"	7-1/4"	6-1/4"
10"	9-3/8"	8-3/8"
12"	11-1/2"	10-1/2"
14"	13-1/4"	12-1/4"

PRESTIGE NEWEL POSTS - 2017

P
R
E
S
T
I
G
E

N
E
W
E
L

P
O
S
T
S

HEIGHT	WIDTH				
	6	8	10	12	14
22	\$42.27	\$56.36	\$70.45	\$84.54	\$98.63
24	\$46.12	\$61.49	\$76.86	\$92.22	\$107.59
26	\$49.96	\$66.61	\$83.26	\$99.91	\$116.56
28	\$53.80	\$71.73	\$89.66	\$107.59	\$125.53
30	\$57.64	\$76.86	\$96.07	\$115.28	\$134.49
32	\$61.49	\$81.98	\$102.47	\$122.97	\$143.46
34	\$65.33	\$87.10	\$108.87	\$130.65	\$152.43
36	\$69.17	\$92.22	\$115.28	\$138.34	\$161.39
38	\$73.01	\$97.35	\$121.68	\$146.02	\$170.36
40	\$76.86	\$102.47	\$128.09	\$153.71	\$179.33
42	\$80.70	\$107.59	\$134.49	\$161.39	\$188.30
44	\$84.54	\$112.72	\$140.90	\$169.08	\$197.26
46	\$88.38	\$117.84	\$147.30	\$176.77	\$206.23
48	\$92.22	\$122.97	\$153.71	\$184.45	\$215.20

NEWEL OPTIONS		SELECT	SELECTED OPTIONS
FLUTED - 25% Upcharge	(FL)	<input type="checkbox"/>	
RAISED PANEL - 20% Upcharge	(RA)	<input type="checkbox"/>	
RECESSED PANEL - 35% Upcharge	(RS)	<input type="checkbox"/>	
RECESSED FLUSH TRIM - 45% Upcharge	(RBF)	<input type="checkbox"/>	
STANDARD FLAT LID (FC)	6" - 10" LID - 15% Upcharge	<input type="checkbox"/>	
	12" - 14" LID - 20% Upcharge	<input type="checkbox"/>	
CHAMFERED LID (CC)	6" - 10" LID - 25% Upcharge	<input type="checkbox"/>	
	12" - 14" LID - 35% Upcharge	<input type="checkbox"/>	
PRICING INSTRUCTIONS			\$ -
PRICE	ENTER PRICE INTO BLUE CELL		



PRESTIGE NEWEL POST STYLES:



PLAIN

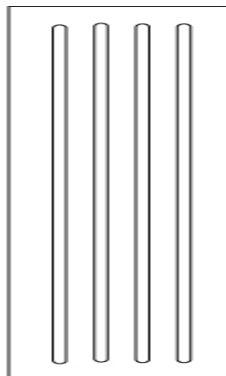

FLUTED

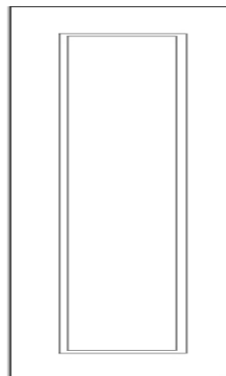

RAISED
PANEL

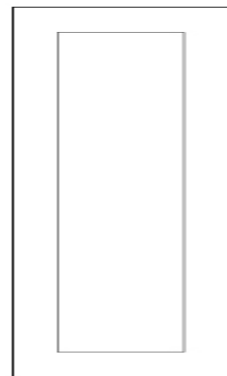

RECESSED
SQUARE EDGE

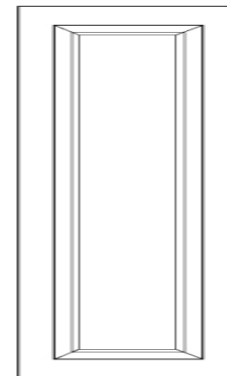

RECESSED
TRIM EDGE

**PRICES SUBJECT TO CHANGE WITHOUT NOTICE

PRESTIGE PLINTH BOXES - 2017

**P
R
E
S
T
I
G
E

P
L
I
N
T
H

B
O
X
E
S**

H E I G H T	W I D T H					
	16	18	20	22	24	26
22	\$99.74	\$112.20	\$124.67	\$137.14	\$149.60	\$162.07
24	\$108.81	\$122.40	\$136.00	\$149.60	\$163.21	\$176.81
26	\$117.87	\$132.60	\$147.34	\$162.07	\$176.81	\$191.54
28	\$126.93	\$142.81	\$158.67	\$174.54	\$190.40	\$206.27
30	\$136.00	\$153.00	\$170.00	\$187.00	\$204.00	\$221.00
32	\$145.07	\$163.21	\$181.34	\$199.47	\$217.60	\$235.74
34	\$154.14	\$173.40	\$192.67	\$211.94	\$231.21	\$250.47
36	\$163.21	\$183.60	\$204.00	\$224.41	\$244.81	\$265.21
38	\$172.27	\$193.81	\$215.34	\$236.88	\$258.41	\$279.94
40	\$181.34	\$204.00	\$226.67	\$249.34	\$272.00	\$294.67
42	\$190.40	\$214.21	\$238.00	\$261.81	\$285.61	\$309.41
44	\$199.47	\$224.41	\$249.34	\$274.27	\$299.21	\$324.14
46	\$208.54	\$234.60	\$260.67	\$286.74	\$312.81	\$338.88
48	\$217.60	\$244.81	\$272.00	\$299.21	\$326.41	\$353.61

P L I N T H O P T I O N S		S E L E C T	S E L E C T E D O P T I O N S
FLUTED - 25% Upcharge	(FL)	<input type="checkbox"/>	
RAISED PANEL - 20% Upcharge	(RA)	<input type="checkbox"/>	
RECESSED PANEL - 35% Upcharge	(RS)	<input type="checkbox"/>	
RECESSED FLUSH TRIM - 45% Upcharge	(RBF)	<input type="checkbox"/>	
STANDARD FLAT LID (FC)	6" - 10" LID - 15% Upcharge	<input type="checkbox"/>	
	12" - 14" LID - 20% Upcharge	<input type="checkbox"/>	
CHAMFERED LID (CC)	6" - 10" LID - 25% Upcharge	<input type="checkbox"/>	
	12" - 14" LID - 35% Upcharge	<input type="checkbox"/>	
P R I C I N G I N S T R U C T I O N S			\$ -
PRICE	ENTER PRICE INTO BLUE CELL		

PRESTIGE PLINTH BOX STYLES:



PLAIN

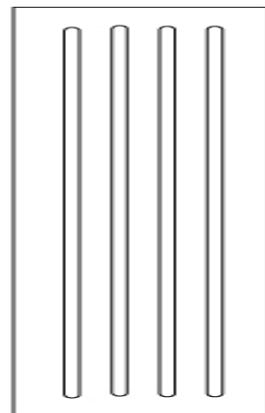

FLUTED

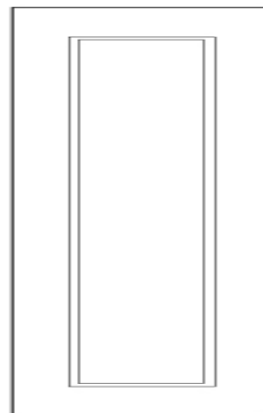

RAISED
PANEL

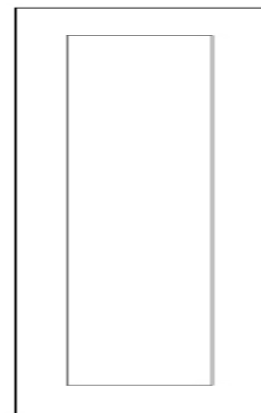

RECESSED
SQUARE EDGE

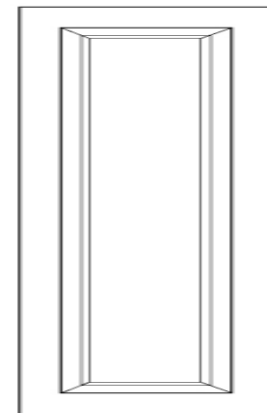

RECESSED
TRIM EDGE

****PRICES SUBJECT TO CHANGE WITHOUT NOTICE**



PRESTIGE SOFFIT - 2017

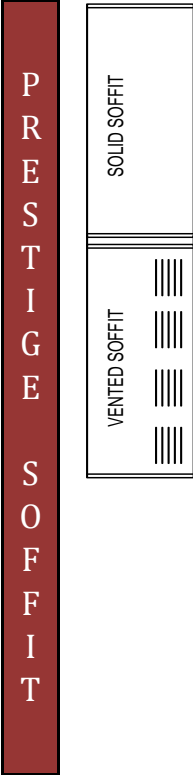

	PRODUCT CODE	DESCRIPTION	NATURAL FINISH		PRE-FINISHED		STAINED	
			PER PIECE PRICE	PER BOX PRICE	PER PIECE PRICE	PER BOX PRICE	PER PIECE PRICE	PER BOX PRICE
SOLID SOFFIT	<i>*SOLD IN BOXES OF 6PCS</i>							
	PSFS1212-48	Soffit - PVC, Solid - 1/2" x 12" x 48" /w Easy Fit System	\$ 27.46	\$ 164.77	\$ 35.70	\$ 214.21	\$ 51.77	\$ 310.60
	PSFS1216-48	Soffit - PVC, Solid - 1/2" x 16" x 48" /w Easy Fit System	\$ 35.54	\$ 213.24	\$ 46.20	\$ 277.21	\$ 67.00	\$ 401.96
	PSFS1224-48	Soffit - PVC, Solid - 1/2" x 24" x 48" /w Easy Fit System	\$ 53.31	\$ 319.86	\$ 69.30	\$ 415.82	\$ 100.48	\$ 602.93
VENTED SOFFIT	<i>*SOLD IN BOXES OF 6PCS</i>							
	PSFV1212-48	Soffit - PVC, Vented - 1/2" x 12" x 48" /w Easy Fit System	\$ 36.35	\$ 218.08	\$ 47.25	\$ 283.51	\$ 68.51	\$ 411.09
	PSFV1216-48	Soffit - PVC, Vented - 1/2" x 16" x 48" /w Easy Fit System	\$ 48.46	\$ 290.78	\$ 63.00	\$ 378.01	\$ 91.36	\$ 548.12
	PSFV1224-48	Soffit - PVC, Vented - 1/2" x 24" x 48" /w Easy Fit System	\$ 72.69	\$ 436.17	\$ 94.50	\$ 567.02	\$ 137.03	\$ 822.18
SOFFIT KITS	<i>*SOLD IN BOXES OF 8PCS</i>							
	PSFS1212-K5C	Soffit - PVC - Kit - 5pcs Vented Soffit 1/2" x 12" x 48", 2pcs Corner Panel & 1pc 4' Spline		\$ 252.42		\$ 324.83		\$ 469.12
	PSFS1216-K5C	Soffit - PVC - Kit - 5pcs Vented Soffit 1/2" x 16" x 48", 2pcs Corner Panel & 1pc 4' Spline		\$ 330.94		\$ 414.99		\$ 616.02
	PSFS1224-K5C	Soffit - PVC - Kit - 5pcs Vented Soffit 1/2" x 24" x 48", 2pcs Corner Panel & 1pc 4' Spline		\$ 469.82		\$ 638.12		\$ 914.65
TRANSITION CORNERS	PSFC1212-12	Soffit - PVC, Solid - 1/2" x 12" x 12" /w Easy Fit System	\$ 9.69		\$ 12.60		\$ 16.38	
	PSFC1216-16	Soffit - PVC, Solid - 1/2" x 16" x 16" /w Easy Fit System	\$ 12.12		\$ 15.75		\$ 20.47	
	PSFC1224-16	Soffit - PVC, Solid - 1/2" x 24" x 16" /w Easy Fit System	\$ 18.17		\$ 23.63		\$ 30.72	
INSERT MOULD	PSTM-48	Soffit - PVC, "Spline" 1/4" x 2" x 48"	\$ 9.24		\$ 12.01		\$ 15.61	

****PRICES SUBJECT TO CHANGE WITHOUT NOTICE**

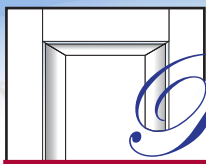

Prestige SHUTTERS

Innovative PVC Systems



*Shutters shown above:
Distinctive Collection, Raised Panel*



The Prestige Advantage

Beautiful

- Classic Architectural Look
- No Visible Fasteners
- Wide Assortment of Styles

Easy Installation

- Complete Kit, with Fasteners & Adhesive
- No Special Tools Needed
- Flat-Pack for Safe & Easy Transportation

Virtually Maintenance Free

- Free-Foam Cellular PVC Construction
- Weather, Decay and Insect Resistant
- Paint Friendly with Acrylic Latex Paints

Prestige Shutters are available in two style categories to best accommodate our customers needs.

The **DECOR COLLECTION**, at a lower cost, shows a beautiful traditional profile but is manufactured using a single PVC sheet with the profile engraved directly to the surface.

The **DISTINCTIVE COLLECTION** is made with true traditional rail and stile construction creating a strong, durable shutter to enjoy for years to come.

All **shutters** are custom ordered to suit your project.

DECOR COLLECTION

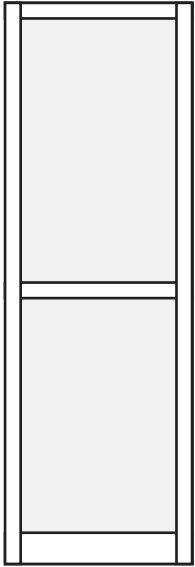

Recessed Flat Panel

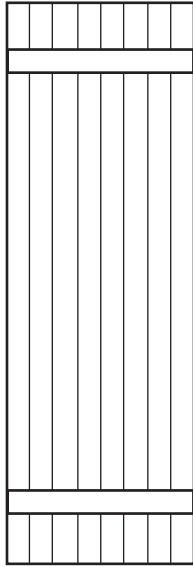

Board & Batten

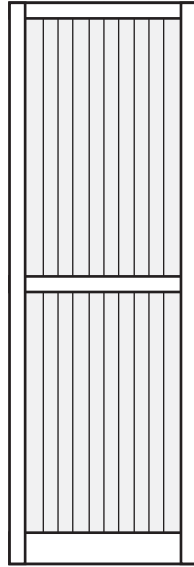

Recessed V-Groove Panel

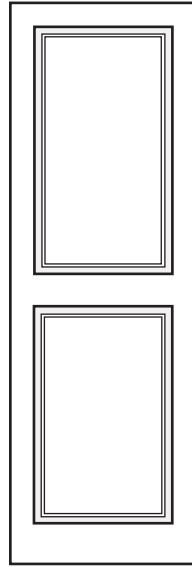

Raised Panel (Routed)



Standard Measurements for **Decor Collection & Distinctive Collections.**

Thickness:	1"
Vertical Stile Width:	2 1/2"
Top Rail Height:	2 1/2"
Middle Rail Height:	2 1/2"
Bottom Rail Height:	4 1/2"

DISTINCTIVE COLLECTION

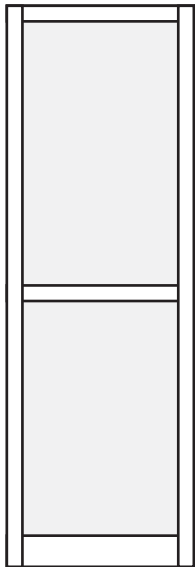

Recessed Flat Panel

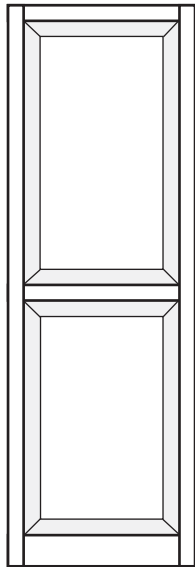

Raised Panel

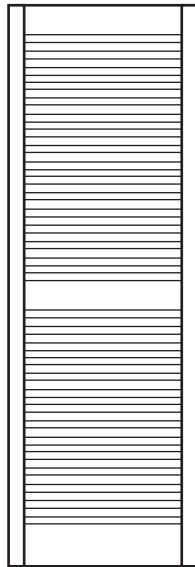

Louvre-Closed



Decor Collection - Raised Panel

Distinctive Collection - Raised Panel

Distinctive Collection - Closed Louvre

PRESTIGE PVC SHUTTER POLICIES

- 1 **Once an order has been placed , it is non-cancelable and non-returnable.**
- 2 **Only complete orders will be accepted.**
 - Partial orders that are missing key information such as: colour, size, ship to location, etc. Will not be accepted
 - Changes Will not be accepted once original order has been allocated for manufacturing
 - Changes Will be accepted prior to allocation. The original order Will be cancelled and The Changes Will be entered as a new order with a new ship date
- 3 **Decor/Distinctive Collections are designed with "key hole" hanging system and come with fasteners for HANGING**
(NO FACE DAMAGE NESSACCARY BY USE OF SCREWS THROUGH FINISHED FACE)

Prices do not include Hardware (see collection tabs to add hardware)
- for hardware options and pricing please see The hardware tab
 - Shutters from 12" to 48" in height require the use of 2 Hinges
 - Shutters from 49" to 96" in height require the use of 3 Hinges
 - Shutters from 97" to 144" in height require the use of 4 Hinges
 - Shutters over 144" in height require the use of 5 Hinges
- 4 **Prices do not include freight. All products are F.O.B Oakville, Ontario**
 - Additional charges may apply for shipments outside of Canada, to residential addresses/locations or construction sites
 - Additional charges may apply for special requests on shipping, packaging & delivery
- 5 Prices reflect the price per pair
- 6 Pricing for a single shutter will half the price of a shutter pair, Design options will receive the entire per pair price
- 7 Pricing is based on 6 standard colours
 - a one time \$150 fee will assessed for all custom colour requests with a minimum of 1 Gallon
 - a primed finish option is available on all Shutters
- 8 Shutter heights and widths are available in 1/8" increments
- 9 Heights at less than 30" are priced at a 30" minimum
- 10 **All product needs to be inspected immediately upon receipt of delivery**
Freight damage claims received after 12 days of receipt of delivery will result in No Credit
- 11 Shutter sizes exceeding 90" in length or width will have an additional freight charge please contact your sales rep for quotation
- 12 Special shipping crate may be required for oversize shipments and/or any orders shipped outside of Ontario.
An additional freight charge please contact your sales rep for quotation





SHUTTER HARDWARE - 2017



Innovative PVC Systems

S
H
U
T
T
E
R

H
A
R
D
W
A
R
E

		DESCRIPTION		PRICE	NEEDED	TOTAL
HINGES 		- 12" Hinge Arm - Sold in pairs, 2 pairs per window - Offsets available: 0", 1", 2" & 3" - Sold in pairs - Stainless Steel		\$ 84.24	0	\$ -
NEW YORK HINGE 		- Sets of 4 Hinges /w 4 Pintels - 6 3/4"w x 5"h - Strengthens corners of the shutter - Offsets available: 0", 1 1/2" & 2 1/8" - Cast Iron construction /w rust resistant paint		\$ 302.64	0	\$ -
PINTELS 		- Sold in pairs (2 pairs per window) - Offsets available: 1/2", 1 1/2" & 2 1/4" - Stainless Steel		\$ 99.84	0	\$ -
"S" SHUTTER DOG 		- 7" Tall with 4" Lag - Sold in pairs - Stainless Steel		\$ 127.92	0	\$ -
				SELECTION TOTAL	\$	-

**PRICES SUBJECT TO CHANGE WITHOUT NOTICE



DECOR COLLECTION SHUTTERS - 2017



RAISED PANEL



		WIDTH										
		12	14	16	18	20	22	24	26	28	30	32
H E I G H T	24	\$ 81.26	\$ 94.80	\$ 108.34	\$ 121.89	\$ 135.43	\$ 148.97	\$ 162.51	\$ 176.06	\$ 189.60	\$ 203.14	\$ 216.68
	30	\$ 101.57	\$ 118.50	\$ 135.43	\$ 152.35	\$ 169.29	\$ 186.22	\$ 203.14	\$ 220.07	\$ 237.00	\$ 253.93	\$ 270.86
	36	\$ 121.89	\$ 142.20	\$ 162.51	\$ 182.83	\$ 203.14	\$ 223.46	\$ 243.77	\$ 264.09	\$ 284.40	\$ 304.72	\$ 325.03
	42	\$ 142.20	\$ 165.90	\$ 189.60	\$ 213.30	\$ 237.00	\$ 260.70	\$ 284.40	\$ 308.10	\$ 331.80	\$ 355.50	\$ 379.20
	48	\$ 162.51	\$ 189.60	\$ 216.68	\$ 243.77	\$ 270.86	\$ 297.94	\$ 325.03	\$ 352.11	\$ 379.20	\$ 406.28	\$ 433.37
	54	\$ 182.83	\$ 213.30	\$ 243.77	\$ 274.24	\$ 304.72	\$ 335.19	\$ 365.66	\$ 396.13	\$ 426.60	\$ 457.07	\$ 487.54
	60	\$ 203.14	\$ 237.00	\$ 270.86	\$ 304.72	\$ 338.57	\$ 372.43	\$ 406.28	\$ 440.15	\$ 474.00	\$ 507.86	\$ 541.71
	66	\$ 223.46	\$ 260.70	\$ 297.94	\$ 335.19	\$ 372.43	\$ 409.67	\$ 446.91	\$ 484.16	\$ 521.40	\$ 558.65	\$ 595.88
	72	\$ 243.77	\$ 284.40	\$ 325.03	\$ 365.66	\$ 406.28	\$ 446.91	\$ 487.54	\$ 528.17	\$ 568.80	\$ 609.43	\$ 650.05
	78	\$ 264.09	\$ 308.10	\$ 352.11	\$ 396.13	\$ 440.15	\$ 484.16	\$ 528.17	\$ 572.19	\$ 616.20	\$ 660.21	\$ 704.23
	84	\$ 284.40	\$ 331.80	\$ 379.20	\$ 426.60	\$ 474.00	\$ 521.40	\$ 568.80	\$ 616.20	\$ 663.60	\$ 711.00	\$ 758.40
	90	\$ 304.72	\$ 355.50	\$ 406.28	\$ 457.07	\$ 507.86	\$ 558.65	\$ 609.43	\$ 660.21	\$ 711.00	\$ 761.79	\$ 812.57
	96	\$ 325.03	\$ 379.20	\$ 433.37	\$ 487.54	\$ 541.71	\$ 595.88	\$ 650.05	\$ 704.23	\$ 758.40	\$ 812.57	\$ 866.74
	102	\$ 345.35	\$ 402.90	\$ 460.46	\$ 518.02	\$ 575.57	\$ 633.13	\$ 690.68	\$ 748.25	\$ 805.80	\$ 863.36	\$ 920.92
108	\$ 365.66	\$ 426.60	\$ 487.54	\$ 548.49	\$ 609.43	\$ 670.37	\$ 731.31	\$ 792.26	\$ 853.20	\$ 914.14	\$ 975.09	
114	\$ 385.97	\$ 450.30	\$ 514.63	\$ 578.96	\$ 643.29	\$ 707.62	\$ 771.94	\$ 836.27	\$ 900.60	\$ 964.93	\$ 1,029.26	
120	\$ 406.28	\$ 474.00	\$ 541.71	\$ 609.43	\$ 677.14	\$ 744.86	\$ 812.57	\$ 880.29	\$ 948.00	\$ 1,015.72	\$ 1,083.43	

**PRICES SUBJECT TO CHANGE WITHOUT NOTICE

SHUTTER OPTIONS		SELECT	SELECTED OPTIONS
FRAMES	SINGLE PANEL - 5% Upcharge	<input type="checkbox"/>	
	TRIPLE PANEL - 10% Upcharge	<input type="checkbox"/>	
	CUSTOM RAIL - 15% Upcharge	<input type="checkbox"/>	
	CUSTOM SHUTTER DETAIL - 25% Upcharge	<input type="checkbox"/>	
	ARCHED TOP - 25% Upcharge	<input type="checkbox"/>	
PRICING INSTRUCTIONS			\$ -
ENTER PRICE INTO BLUE CELL			
HANGING OPTIONS:	FLUSH MOUNT (WOOD/SIDING) INCLUDED	<input type="checkbox"/>	
	FACE MOUNT (CONCRETE/BRICK)	<input type="checkbox"/>	
	HINGES (SEE HARDWARE PAGE)	<input type="checkbox"/>	
HARDWARE PAGE LINK			
		TOTAL	\$ -

- *Sold in Pairs
- **Prices reflect double panel shutters with even sized panels.
- *Prices subject to change without notice

PRICE LEVEL
STOCKING



DECOR COLLECTION SHUTTERS - 2017



RECESSED PANEL

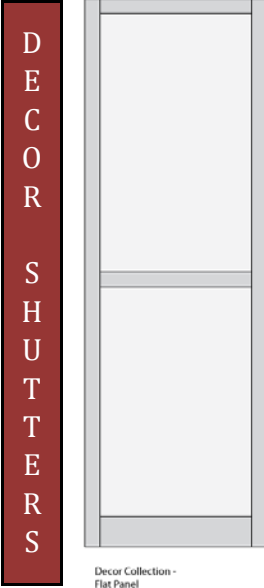

HEIGHT	WIDTH										
	12	14	16	18	20	22	24	26	28	30	32
24	\$86.89	\$101.37	\$115.85	\$130.33	\$144.82	\$159.30	\$173.78	\$188.26	\$202.75	\$217.22	\$231.71
30	\$108.62	\$126.71	\$144.82	\$162.92	\$181.02	\$199.13	\$217.22	\$235.33	\$253.43	\$271.53	\$289.64
36	\$130.33	\$152.06	\$173.78	\$195.50	\$217.22	\$238.95	\$260.67	\$282.39	\$304.11	\$325.84	\$347.56
42	\$152.06	\$177.40	\$202.75	\$228.09	\$253.43	\$278.77	\$304.11	\$329.46	\$354.80	\$380.15	\$405.48
48	\$173.78	\$202.75	\$231.71	\$260.67	\$289.64	\$318.60	\$347.56	\$376.52	\$405.48	\$434.45	\$463.41
54	\$195.50	\$228.09	\$260.67	\$293.26	\$325.84	\$358.42	\$391.01	\$423.59	\$456.17	\$488.75	\$521.34
60	\$217.22	\$253.43	\$289.64	\$325.84	\$362.04	\$398.24	\$434.45	\$470.66	\$506.86	\$543.06	\$579.26
66	\$238.95	\$278.77	\$318.60	\$358.42	\$398.24	\$438.07	\$477.90	\$517.72	\$557.54	\$597.37	\$637.19
72	\$260.67	\$304.11	\$347.56	\$391.01	\$434.45	\$477.90	\$521.34	\$564.79	\$608.23	\$651.68	\$695.12
78	\$282.39	\$329.46	\$376.52	\$423.59	\$470.66	\$517.72	\$564.79	\$611.85	\$658.92	\$705.98	\$753.05
84	\$304.11	\$354.80	\$405.48	\$456.17	\$506.86	\$557.54	\$608.23	\$658.92	\$709.60	\$760.29	\$810.97
90	\$325.84	\$380.15	\$434.45	\$488.75	\$543.06	\$597.37	\$651.68	\$705.98	\$760.29	\$814.59	\$868.90
96	\$347.56	\$405.48	\$463.41	\$521.34	\$579.26	\$637.19	\$695.12	\$753.05	\$810.97	\$868.90	\$926.83
102	\$369.28	\$430.83	\$492.37	\$553.92	\$615.47	\$677.01	\$738.56	\$800.12	\$861.66	\$923.21	\$984.76
108	\$391.01	\$456.17	\$521.34	\$586.50	\$651.68	\$716.84	\$782.01	\$847.18	\$912.34	\$977.51	\$1,042.68
114	\$412.73	\$481.52	\$550.30	\$619.09	\$687.88	\$756.67	\$825.45	\$894.25	\$963.03	\$1,031.82	\$1,100.60
120	\$434.45	\$506.86	\$579.26	\$651.68	\$724.08	\$796.49	\$868.90	\$941.31	\$1,013.72	\$1,086.12	\$1,158.53

****PRICES SUBJECT TO CHANGE WITHOUT NOTICE**

SHUTTER OPTIONS		SELECT	SELECTED OPTIONS
FRAMES	SINGLE PANEL - 5% Upcharge	<input type="checkbox"/>	
	TRIPLE PANEL - 10% Upcharge	<input type="checkbox"/>	
	CUSTOM RAIL - 15% Upcharge	<input type="checkbox"/>	
	CUSTOM SHUTTER DETAIL - 25% Upcharge	<input type="checkbox"/>	
	ARCHED TOP - 25% Upcharge	<input type="checkbox"/>	
PRICING INSTRUCTIONS			\$ -
ENTER PRICE INTO BLUE CELL			
HANGING OPTIONS:	FLUSH MOUNT (WOOD/SIDING) INCLUDED	<input type="checkbox"/>	
	FACE MOUNT (CONCRETE/BRICK)	<input type="checkbox"/>	
	HINGES (SEE HARDWARE PAGE)	<input type="checkbox"/>	
HARDWARE PAGE LINK			
TOTAL		\$	-

*Sold in Pairs
 **Prices reflect double panel shutters with even sized panels.
 *Prices subject to change without notice

PRICE LEVEL
STOCKING



DECOR COLLECTION SHUTTERS - 2017



BOARD & BATTEN

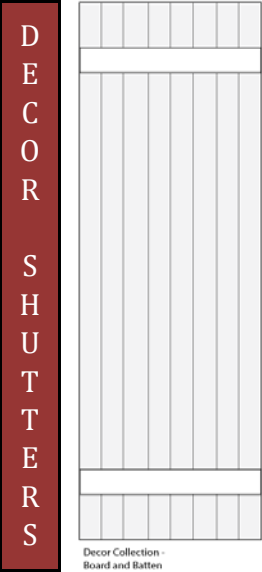

H E I G H T	W I D T H										
	12	14	16	18	20	22	24	26	28	30	32
24	\$88.93	\$103.75	\$118.57	\$133.40	\$148.22	\$163.04	\$177.86	\$192.69	\$207.51	\$222.33	\$237.15
30	\$111.16	\$129.69	\$148.22	\$166.75	\$185.27	\$203.80	\$222.33	\$240.85	\$259.38	\$277.91	\$296.43
36	\$133.40	\$155.63	\$177.86	\$200.09	\$222.33	\$244.56	\$266.79	\$289.03	\$311.26	\$333.49	\$355.72
42	\$155.63	\$181.57	\$207.51	\$233.45	\$259.38	\$285.32	\$311.26	\$337.19	\$363.13	\$389.07	\$415.01
48	\$177.86	\$207.51	\$237.15	\$266.79	\$296.43	\$326.08	\$355.72	\$385.37	\$415.01	\$444.66	\$474.30
54	\$200.09	\$233.45	\$266.79	\$300.14	\$333.49	\$366.84	\$400.19	\$433.54	\$466.89	\$500.24	\$533.58
60	\$222.33	\$259.38	\$296.43	\$333.49	\$370.55	\$407.60	\$444.66	\$481.71	\$518.76	\$555.82	\$592.87
66	\$244.56	\$285.32	\$326.08	\$366.84	\$407.60	\$448.36	\$489.12	\$529.88	\$570.64	\$611.40	\$652.16
72	\$266.79	\$311.26	\$355.72	\$400.19	\$444.66	\$489.12	\$533.58	\$578.05	\$622.52	\$666.98	\$711.45
78	\$289.03	\$337.19	\$385.37	\$433.54	\$481.71	\$529.88	\$578.05	\$626.22	\$674.39	\$722.57	\$770.73
84	\$311.26	\$363.13	\$415.01	\$466.89	\$518.76	\$570.64	\$622.52	\$674.39	\$726.27	\$778.15	\$830.02
90	\$333.49	\$389.07	\$444.66	\$500.24	\$555.82	\$611.40	\$666.98	\$722.57	\$778.15	\$833.73	\$889.31
96	\$355.72	\$415.01	\$474.30	\$533.58	\$592.87	\$652.16	\$711.45	\$770.73	\$830.02	\$889.31	\$948.60
102	\$377.96	\$440.95	\$503.94	\$566.94	\$629.93	\$692.92	\$755.91	\$818.91	\$881.90	\$944.89	\$1,007.88
108	\$400.19	\$466.89	\$533.58	\$600.28	\$666.98	\$733.68	\$800.37	\$867.08	\$933.78	\$1,000.48	\$1,067.17
114	\$422.42	\$492.82	\$563.23	\$633.63	\$704.03	\$774.44	\$844.84	\$915.25	\$985.65	\$1,056.06	\$1,126.46
120	\$444.66	\$518.76	\$592.87	\$666.98	\$741.09	\$815.20	\$889.31	\$963.42	\$1,037.52	\$1,111.64	\$1,185.75

****PRICES SUBJECT TO CHANGE WITHOUT NOTICE**

SHUTTER OPTIONS		SELECT	SELECTED OPTIONS
FRAMES	SINGLE PANEL - 5% Upcharge	<input type="checkbox"/>	
	TRIPLE PANEL - 10% Upcharge	<input type="checkbox"/>	
	CUSTOM RAIL - 15% Upcharge	<input type="checkbox"/>	
	CUSTOM SHUTTER DETAIL - 25% Upcharge	<input type="checkbox"/>	
	ARCHED TOP - 25% Upcharge	<input type="checkbox"/>	
PRICING INSTRUCTIONS			
ENTER PRICE INTO BLUE CELL			
HANGING OPTIONS:	FLUSH MOUNT (WOOD/SIDING) INCLUDED	<input type="checkbox"/>	
	FACE MOUNT (CONCRETE/BRICK)	<input type="checkbox"/>	
	HINGES (SEE HARDWARE PAGE)	<input type="checkbox"/>	
HARDWARE PAGE LINK			
TOTAL		\$	-

*Sold in Pairs
 **Prices reflect double panel shutters with even sized panels.
 *Prices subject to change without notice

PRICE LEVEL
STOCKING

BOARD & "Z" BATTEN

DECOR SHUTTERS

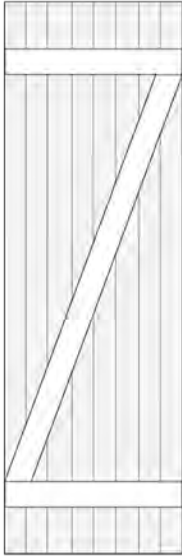

Decor Collection - Board and Batten - Z Pattern

		WIDTH										
		12	14	16	18	20	22	24	26	28	30	32
HEIGHT	24	\$93.18	\$108.71	\$124.24	\$139.77	\$155.30	\$170.83	\$186.36	\$201.89	\$217.42	\$232.95	\$248.48
	30	\$116.48	\$135.89	\$155.30	\$174.71	\$194.13	\$213.54	\$232.95	\$252.37	\$271.77	\$291.19	\$310.61
	36	\$139.77	\$163.07	\$186.36	\$209.66	\$232.95	\$256.25	\$279.54	\$302.84	\$326.14	\$349.43	\$372.72
	42	\$163.07	\$190.24	\$217.42	\$244.60	\$271.77	\$298.96	\$326.14	\$353.31	\$380.49	\$407.67	\$434.84
	48	\$186.36	\$217.42	\$248.48	\$279.54	\$310.61	\$341.67	\$372.72	\$403.78	\$434.84	\$465.90	\$496.97
	54	\$209.66	\$244.60	\$279.54	\$314.49	\$349.43	\$384.37	\$419.31	\$454.26	\$489.20	\$524.14	\$559.09
	60	\$232.95	\$271.77	\$310.61	\$349.43	\$388.25	\$427.08	\$465.90	\$504.73	\$543.56	\$582.38	\$621.21
	66	\$256.25	\$298.96	\$341.67	\$384.37	\$427.08	\$469.79	\$512.50	\$555.20	\$597.91	\$640.62	\$683.33
	72	\$279.54	\$326.14	\$372.72	\$419.31	\$465.90	\$512.50	\$559.09	\$605.68	\$652.26	\$698.86	\$745.45
	78	\$302.84	\$353.31	\$403.78	\$454.26	\$504.73	\$555.20	\$605.68	\$656.15	\$706.63	\$757.09	\$807.57
	84	\$326.14	\$380.49	\$434.84	\$489.20	\$543.56	\$597.91	\$652.26	\$706.63	\$760.98	\$815.33	\$869.69
	90	\$349.43	\$407.67	\$465.90	\$524.14	\$582.38	\$640.62	\$698.86	\$757.09	\$815.33	\$873.57	\$931.81
	96	\$372.72	\$434.84	\$496.97	\$559.09	\$621.21	\$683.33	\$745.45	\$807.57	\$869.69	\$931.81	\$993.93
	102	\$396.02	\$462.02	\$528.03	\$594.03	\$660.03	\$726.03	\$792.04	\$858.04	\$924.05	\$990.05	\$1,056.05
108	\$419.31	\$489.20	\$559.09	\$628.97	\$698.86	\$768.74	\$838.63	\$908.52	\$978.40	\$1,048.28	\$1,118.17	
114	\$442.61	\$516.38	\$590.15	\$663.92	\$737.68	\$811.45	\$885.22	\$958.98	\$1,032.75	\$1,106.52	\$1,180.29	
120	\$465.90	\$543.56	\$621.21	\$698.86	\$776.51	\$854.16	\$931.81	\$1,009.46	\$1,087.11	\$1,164.76	\$1,242.41	

**PRICES SUBJECT TO CHANGE WITHOUT NOTICE

SHUTTER OPTIONS		SELECT	SELECTED OPTIONS
FRAMES	SINGLE PANEL - 5% Upcharge	<input type="checkbox"/>	
	TRIPLE PANEL - 10% Upcharge	<input type="checkbox"/>	
	CUSTOM RAIL - 15% Upcharge	<input type="checkbox"/>	
	CUSTOM SHUTTER DETAIL - 25% Upcharge	<input type="checkbox"/>	
	ARCHED TOP - 25% Upcharge	<input type="checkbox"/>	
PRICING INSTRUCTIONS			\$ -
ENTER PRICE INTO BLUE CELL			
HANGING OPTIONS:	FLUSH MOUNT (WOOD/SIDING) INCLUDED	<input type="checkbox"/>	
	FACE MOUNT (CONCRETE/BRICK)	<input type="checkbox"/>	
	HINGES (SEE HARDWARE PAGE)	<input type="checkbox"/>	
HARDWARE PAGE LINK			
TOTAL			\$ -

*Sold in Pairs

**Prices reflect double panel shutters with even sized panels.

*Prices subject to change without notice



DISTINCTIVE COLLECTION SHUTTERS - 2017



RAISED PANEL

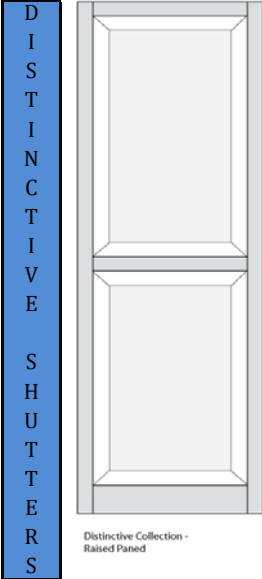

HEIGHT	WIDTH										
	12	14	16	18	20	22	24	26	28	30	32
24	\$ 91.84	\$ 107.14	\$ 122.45	\$ 137.75	\$ 153.06	\$ 168.36	\$ 183.66	\$ 198.97	\$ 214.27	\$ 229.58	\$ 244.89
30	\$ 114.79	\$ 133.92	\$ 153.06	\$ 172.19	\$ 191.32	\$ 210.45	\$ 229.58	\$ 248.72	\$ 267.84	\$ 286.98	\$ 306.11
36	\$ 137.75	\$ 160.71	\$ 183.66	\$ 206.62	\$ 229.58	\$ 252.54	\$ 275.50	\$ 298.46	\$ 321.42	\$ 344.37	\$ 367.33
42	\$ 160.71	\$ 187.49	\$ 214.27	\$ 241.06	\$ 267.84	\$ 294.63	\$ 321.42	\$ 348.20	\$ 374.99	\$ 401.77	\$ 428.56
48	\$ 183.66	\$ 214.27	\$ 244.89	\$ 275.50	\$ 306.11	\$ 336.72	\$ 367.33	\$ 397.95	\$ 428.56	\$ 459.17	\$ 489.78
54	\$ 206.62	\$ 241.06	\$ 275.50	\$ 309.94	\$ 344.37	\$ 378.81	\$ 413.25	\$ 447.68	\$ 482.13	\$ 516.56	\$ 551.00
60	\$ 229.58	\$ 267.84	\$ 306.11	\$ 344.37	\$ 382.64	\$ 420.90	\$ 459.17	\$ 497.43	\$ 535.69	\$ 573.95	\$ 612.22
66	\$ 252.54	\$ 294.63	\$ 336.72	\$ 378.81	\$ 420.90	\$ 462.99	\$ 505.08	\$ 547.17	\$ 589.26	\$ 631.36	\$ 673.44
72	\$ 275.50	\$ 321.42	\$ 367.33	\$ 413.25	\$ 459.17	\$ 505.08	\$ 551.00	\$ 596.91	\$ 642.83	\$ 688.75	\$ 734.67
78	\$ 298.46	\$ 348.20	\$ 397.95	\$ 447.68	\$ 497.43	\$ 547.17	\$ 596.91	\$ 646.66	\$ 696.40	\$ 746.14	\$ 795.89
84	\$ 321.42	\$ 374.99	\$ 428.56	\$ 482.13	\$ 535.69	\$ 589.26	\$ 642.83	\$ 696.40	\$ 749.97	\$ 803.54	\$ 857.11
90	\$ 344.37	\$ 401.77	\$ 459.17	\$ 516.56	\$ 573.95	\$ 631.36	\$ 688.75	\$ 746.14	\$ 803.54	\$ 860.94	\$ 918.33
96	\$ 367.33	\$ 428.56	\$ 489.78	\$ 551.00	\$ 612.22	\$ 673.44	\$ 734.67	\$ 795.89	\$ 857.11	\$ 918.33	\$ 979.55
102	\$ 390.29	\$ 455.34	\$ 520.39	\$ 585.44	\$ 650.48	\$ 715.53	\$ 780.58	\$ 845.63	\$ 910.68	\$ 975.73	\$ 1,040.78
108	\$ 413.25	\$ 482.13	\$ 551.00	\$ 619.87	\$ 688.75	\$ 757.63	\$ 826.50	\$ 895.37	\$ 964.25	\$ 1,033.12	\$ 1,102.00
114	\$ 436.21	\$ 508.91	\$ 581.61	\$ 654.31	\$ 727.01	\$ 799.71	\$ 872.41	\$ 945.12	\$ 1,017.82	\$ 1,090.52	\$ 1,163.22
120	\$ 459.17	\$ 535.69	\$ 612.22	\$ 688.75	\$ 765.28	\$ 841.80	\$ 918.33	\$ 994.86	\$ 1,071.39	\$ 1,147.91	\$ 1,224.44

****PRICES SUBJECT TO CHANGE WITHOUT NOTICE**

SHUTTER OPTIONS		SELECT	SELECTED OPTIONS
FRAMES	SINGLE PANEL - 5% Upcharge	<input type="checkbox"/>	
	TRIPLE PANEL - 10% Upcharge	<input type="checkbox"/>	
	CUSTOM RAIL - 15% Upcharge	<input type="checkbox"/>	
	CUSTOM SHUTTER DETAIL - 25% Upcharge	<input type="checkbox"/>	
	ARCHED TOP - 25% Upcharge	<input type="checkbox"/>	
PRICING INSTRUCTIONS			\$ -
ENTER PRICE INTO BLUE CELL			
HANGING OPTIONS:	FLUSH MOUNT (WOOD/SIDING) INCLUDED	<input type="checkbox"/>	
	FACE MOUNT (CONCRETE/BRICK)	<input type="checkbox"/>	
	HINGES (SEE HARDWARE PAGE)	<input type="checkbox"/>	
HARDWARE PAGE LINK			
TOTAL			\$ -

*Sold in Pairs
 **Prices reflect double panel shutters with even sized panels.
 *Prices subject to change without notice

PRICE LEVEL
STOCKING



DISTINCTIVE COLLECTION SHUTTERS - 2017



RECESSED PANEL

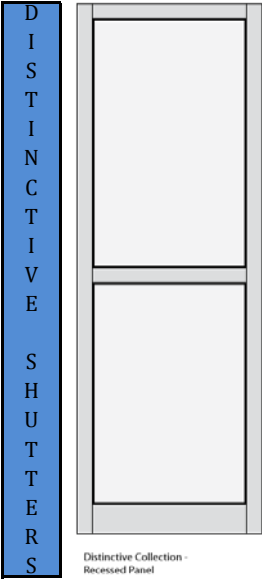

HEIGHT	WIDTH										
	12	14	16	18	20	22	24	26	28	30	32
24	\$ 84.59	\$ 98.69	\$ 112.79	\$ 126.89	\$ 140.99	\$ 155.08	\$ 169.18	\$ 183.28	\$ 197.38	\$ 211.48	\$ 225.57
30	\$ 105.74	\$ 123.36	\$ 140.99	\$ 158.61	\$ 176.23	\$ 193.85	\$ 211.48	\$ 229.10	\$ 246.72	\$ 264.35	\$ 281.97
36	\$ 126.89	\$ 148.03	\$ 169.18	\$ 190.33	\$ 211.48	\$ 232.62	\$ 253.78	\$ 274.92	\$ 296.07	\$ 317.21	\$ 338.37
42	\$ 148.03	\$ 172.71	\$ 197.38	\$ 222.05	\$ 246.72	\$ 271.39	\$ 296.07	\$ 320.74	\$ 345.41	\$ 370.09	\$ 394.76
48	\$ 169.18	\$ 197.38	\$ 225.57	\$ 253.78	\$ 281.97	\$ 310.16	\$ 338.37	\$ 366.56	\$ 394.76	\$ 422.96	\$ 451.15
54	\$ 190.33	\$ 222.05	\$ 253.78	\$ 285.50	\$ 317.21	\$ 348.94	\$ 380.66	\$ 412.38	\$ 444.10	\$ 475.82	\$ 507.55
60	\$ 211.48	\$ 246.72	\$ 281.97	\$ 317.21	\$ 352.46	\$ 387.71	\$ 422.96	\$ 458.20	\$ 493.45	\$ 528.69	\$ 563.94
66	\$ 232.62	\$ 271.39	\$ 310.16	\$ 348.94	\$ 387.71	\$ 426.48	\$ 465.25	\$ 504.02	\$ 542.80	\$ 581.57	\$ 620.34
72	\$ 253.78	\$ 296.07	\$ 338.37	\$ 380.66	\$ 422.96	\$ 465.25	\$ 507.55	\$ 549.84	\$ 592.13	\$ 634.43	\$ 676.72
78	\$ 274.92	\$ 320.74	\$ 366.56	\$ 412.38	\$ 458.20	\$ 504.02	\$ 549.84	\$ 595.66	\$ 641.48	\$ 687.30	\$ 733.12
84	\$ 296.07	\$ 345.41	\$ 394.76	\$ 444.10	\$ 493.45	\$ 542.80	\$ 592.13	\$ 641.48	\$ 690.83	\$ 740.17	\$ 789.52
90	\$ 317.21	\$ 370.09	\$ 422.96	\$ 475.82	\$ 528.69	\$ 581.57	\$ 634.43	\$ 687.30	\$ 740.17	\$ 793.04	\$ 845.91
96	\$ 338.37	\$ 394.76	\$ 451.15	\$ 507.55	\$ 563.94	\$ 620.34	\$ 676.72	\$ 733.12	\$ 789.52	\$ 845.91	\$ 902.31
102	\$ 359.51	\$ 419.43	\$ 479.35	\$ 539.27	\$ 599.18	\$ 659.11	\$ 719.02	\$ 778.94	\$ 838.86	\$ 898.78	\$ 958.70
108	\$ 380.66	\$ 444.10	\$ 507.55	\$ 570.99	\$ 634.43	\$ 697.88	\$ 761.32	\$ 824.77	\$ 888.20	\$ 951.65	\$ 1,015.09
114	\$ 401.81	\$ 468.77	\$ 535.75	\$ 602.71	\$ 669.68	\$ 736.65	\$ 803.61	\$ 870.59	\$ 937.55	\$ 1,004.52	\$ 1,071.49
120	\$ 422.96	\$ 493.45	\$ 563.94	\$ 634.43	\$ 704.93	\$ 775.42	\$ 845.91	\$ 916.40	\$ 986.90	\$ 1,057.39	\$ 1,127.88

****PRICES SUBJECT TO CHANGE WITHOUT NOTICE**

SHUTTER OPTIONS		SELECT	SELECTED OPTIONS
FRAMES	SINGLE PANEL - 5% Upcharge	<input type="checkbox"/>	
	TRIPLE PANEL - 10% Upcharge	<input type="checkbox"/>	
	CUSTOM RAIL - 15% Upcharge	<input type="checkbox"/>	
	CUSTOM SHUTTER DETAIL - 25% Upcharge	<input type="checkbox"/>	
	ARCHED TOP - 25% Upcharge	<input type="checkbox"/>	
PRICING INSTRUCTIONS			\$ -
ENTER PRICE INTO BLUE CELL			
HANGING OPTIONS:	FLUSH MOUNT (WOOD/SIDING) INCLUDED	<input type="checkbox"/>	
	FACE MOUNT (CONCRETE/BRICK)	<input type="checkbox"/>	
	HINGES (SEE HARDWARE PAGE)	<input type="checkbox"/>	
HARDWARE PAGE LINK			
TOTAL			\$ -

*Sold in Pairs
 **Prices reflect double panel shutters with even sized panels.
 *Prices subject to change without notice

PRICE LEVEL
STOCKING



DISTINCTIVE COLLECTION SHUTTERS - 2017



CLOSED LOUVRE

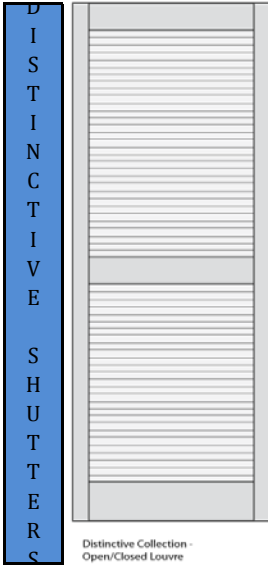

		WIDTH										
		12	14	16	18	20	22	24	26	28	30	32
HEIGHT	24	\$ 103.72	\$ 121.00	\$ 138.29	\$ 155.57	\$ 172.85	\$ 190.14	\$ 207.42	\$ 224.71	\$ 242.00	\$ 259.29	\$ 276.57
	30	\$ 129.64	\$ 151.25	\$ 172.85	\$ 194.46	\$ 216.07	\$ 237.68	\$ 259.29	\$ 280.89	\$ 302.50	\$ 324.10	\$ 345.71
	36	\$ 155.57	\$ 181.50	\$ 207.42	\$ 233.35	\$ 259.29	\$ 285.21	\$ 311.14	\$ 337.07	\$ 362.99	\$ 388.92	\$ 414.86
	42	\$ 181.50	\$ 211.74	\$ 242.00	\$ 272.25	\$ 302.50	\$ 332.74	\$ 362.99	\$ 393.25	\$ 423.50	\$ 453.75	\$ 483.99
	48	\$ 207.42	\$ 242.00	\$ 276.57	\$ 311.14	\$ 345.71	\$ 380.28	\$ 414.86	\$ 449.42	\$ 483.99	\$ 518.56	\$ 553.14
	54	\$ 233.35	\$ 272.25	\$ 311.14	\$ 350.03	\$ 388.92	\$ 427.82	\$ 466.71	\$ 505.60	\$ 544.49	\$ 583.39	\$ 622.28
	60	\$ 259.29	\$ 302.50	\$ 345.71	\$ 388.92	\$ 432.14	\$ 475.35	\$ 518.56	\$ 561.78	\$ 604.99	\$ 648.20	\$ 691.42
	66	\$ 285.21	\$ 332.74	\$ 380.28	\$ 427.82	\$ 475.35	\$ 522.88	\$ 570.43	\$ 617.96	\$ 665.49	\$ 713.03	\$ 760.56
	72	\$ 311.14	\$ 362.99	\$ 414.86	\$ 466.71	\$ 518.56	\$ 570.43	\$ 622.28	\$ 674.13	\$ 725.99	\$ 777.85	\$ 829.70
	78	\$ 337.07	\$ 393.25	\$ 449.42	\$ 505.60	\$ 561.78	\$ 617.96	\$ 674.13	\$ 730.32	\$ 786.49	\$ 842.67	\$ 898.85
	84	\$ 362.99	\$ 423.50	\$ 483.99	\$ 544.49	\$ 604.99	\$ 665.49	\$ 725.99	\$ 786.49	\$ 846.99	\$ 907.49	\$ 967.99
	90	\$ 388.92	\$ 453.75	\$ 518.56	\$ 583.39	\$ 648.20	\$ 713.03	\$ 777.85	\$ 842.67	\$ 907.49	\$ 972.31	\$ 1,037.13
	96	\$ 414.86	\$ 483.99	\$ 553.14	\$ 622.28	\$ 691.42	\$ 760.56	\$ 829.70	\$ 898.85	\$ 967.99	\$ 1,037.13	\$ 1,106.27
102	\$ 440.78	\$ 514.24	\$ 587.71	\$ 661.17	\$ 734.64	\$ 808.10	\$ 881.56	\$ 955.02	\$ 1,028.49	\$ 1,101.95	\$ 1,175.42	
108	\$ 466.71	\$ 544.49	\$ 622.28	\$ 700.06	\$ 777.85	\$ 855.63	\$ 933.42	\$ 1,011.20	\$ 1,088.99	\$ 1,166.77	\$ 1,244.56	
114	\$ 492.64	\$ 574.75	\$ 656.85	\$ 738.96	\$ 821.06	\$ 903.17	\$ 985.27	\$ 1,067.38	\$ 1,149.48	\$ 1,231.59	\$ 1,313.70	
120	\$ 518.56	\$ 604.99	\$ 691.42	\$ 777.85	\$ 864.28	\$ 950.70	\$ 1,037.13	\$ 1,123.56	\$ 1,209.99	\$ 1,296.41	\$ 1,382.84	

****PRICES SUBJECT TO CHANGE WITHOUT NOTICE**

SHUTTER OPTIONS		SELECT	SELECTED OPTIONS
FRAMES	SINGLE PANEL - 5% Upcharge	<input type="checkbox"/>	
	TRIPLE PANEL - 10% Upcharge	<input type="checkbox"/>	
	CUSTOM RAIL - 15% Upcharge	<input type="checkbox"/>	
	CUSTOM SHUTTER DETAIL - 25% Upcharge	<input type="checkbox"/>	
	ARCHED TOP - 25% Upcharge	<input type="checkbox"/>	
PRICING INSTRUCTIONS			
ENTER PRICE INTO BLUE CELL			
HANGING OPTIONS:	FLUSH MOUNT (WOOD/SIDING) INCLUDED	<input type="checkbox"/>	
	FACE MOUNT (CONCRETE/BRICK)	<input type="checkbox"/>	
	HINGES (SEE HARDWARE PAGE)	<input type="checkbox"/>	
HARDWARE PAGE LINK			
		TOTAL	\$ -

*Sold in Pairs

**Prices reflect double panel shutters with even sized panels.

*Prices subject to change without notice

PRESTIGE FLEX SHUTTERS - 2017

PRICE LEVEL
STOCKING

FLEX SHUTTERS

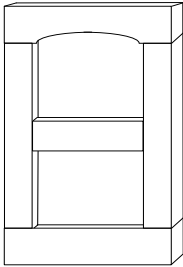

RECESSED PANEL

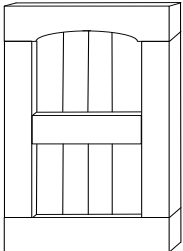

V GROOVE

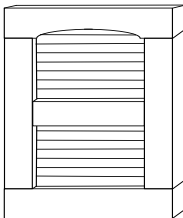

CLOSED LOUVRE

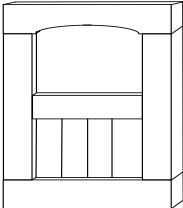

MIXED PANELS

FLEX SHUTTERS

PRODUCT CODE	DESCRIPTION
SFRFV-1648	16" x 48" Reversible Shutter (V Groove/Recessed)
SFRFV-1660	16" x 60" Reversible Shutter (V Groove/Recessed)
SFRFV-1672	16" x 72" Reversible Shutter (V Groove/Recessed)
SFRLF-1648	16" x 48" Reversible Shutter (Closed Louvre/Recessed)
SFRLF-1660	16" x 60" Reversible Shutter (Closed Louvre/Recessed)
SFRLF-1672	16" x 72" Reversible Shutter (Closed Louvre/Recessed)

TOP FRAME ACCESSORIES

SFACC-RT	Round Top (16" Full Round)
SFACC-HT	Half Round Top (16" 1/4 Round)
SFACC-TT	Tapered Top (16" Taper)
SFACC-LA	Low Arch Top (8" 1/4 Round)
SFACC-LR	Round Top (Low)(8" Full Round)

PAIR COST	
\$	178.45
\$	199.59
\$	204.35
\$	219.24
\$	240.39
\$	245.14

\$	40.44
\$	40.44
\$	40.44
\$	22.59
\$	22.59

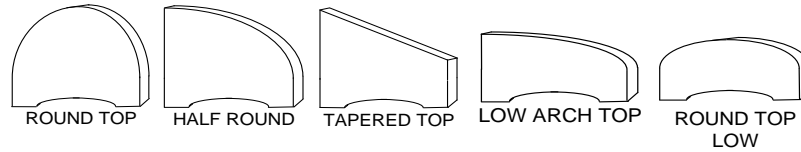

*SHUTTERS CAN BE CUT TO SUIT HEIGHT



*SELECT "V" GROOVE OR RECESSED PANEL OR CLOSED LOUVRE OR MIX MATCH (I.E. RECESSED/"V" GROOVE)

**PRICES SUBJECT TO CHANGE WITHOUT NOTICE

PRESTIGE LOUVRES - 2017

P
R
E
S
T
I
G
E

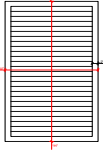
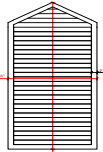
L
O
U
V
R
E
S

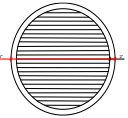
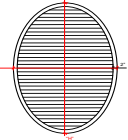
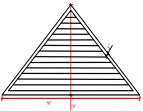
	PRODUCT CODE	DESCRIPTION	WIDTH (IN)	HEIGHT (IN)	STANDARD PACKAGE
 <p><u>RECTANGLE</u></p>	LPC3G-12(24)	Prestige PVC Louvre, 12" x 24" Rectangle, Closed Louvre /w Brick Mould Surround & Sill	12	24	\$ 30.92
	LPC3G-16(36)	Prestige PVC Louvre, 16" x 36" Rectangle, Closed Louvre /w Brick Mould Surround & Sill	16	36	\$ 44.94
	LPC3G-20(48)	Prestige PVC Louvre, 20" x 48" Rectangle, Closed Louvre /w Brick Mould Surround & Sill	20	48	\$ 69.27
 <p><u>PEAK TOP</u></p>	LPC3K-12(48)	Prestige PVC Louvre, 12" x 24" Peak Top Rectangle, Closed Louvre /w Brick Mould Surround & Sill	12	48	\$ 33.43
	LPC3K-16(48)	Prestige PVC Louvre, 16" x 36" Peak Top Rectangle, Closed Louvre /w Brick Mould Surround & Sill	16	48	\$ 48.59
	LPC3K-20(48)	Prestige PVC Louvre, 20" x 48" Peak Top Rectangle, Closed Louvre /w Brick Mould Surround & Sill	20	48	\$ 74.88
 <p><u>ROUND TOP</u></p>	LPC3H-12(48)	Prestige PVC Louvre, 12" x 24" Round Top Rectangle, Closed Louvre /w Brick Mould Surround & Sill	12	48	\$ 35.11
	LPC3H-16(48)	Prestige PVC Louvre, 16" x 36" Round Top Rectangle, Closed Louvre /w Brick Mould Surround & Sill	16	48	\$ 51.01
	LPC3H-20(48)	Prestige PVC Louvre, 20" x 48" Round Top Rectangle, Closed Louvre /w Brick Mould Surround & Sill	20	48	\$ 78.63
 <p><u>ROUND</u></p>	LPC1A-16	Prestige PVC Louvre, 16"ID Round, Closed Louvre /w 4/4" x 3 1/2" Frame	16	16	\$ 38.47
	LPC1A-20	Prestige PVC Louvre, 20"ID Round, Closed Louvre /w 4/4" x 3 1/2" Frame	20	20	\$ 49.62
	LPC1A-24	Prestige PVC Louvre, 24"ID Round, Closed Louvre /w 4/4" x 3 1/2" Frame	24	24	\$ 54.67
 <p><u>OVAL</u></p>	LPC1C-16(36)	Prestige PVC Louvre, 16" x 36"ID Oval, Closed Louvre /w 4/4" x 3 1/2" Frame	16	36	\$ 75.30
	LPC1C-18(42)	Prestige PVC Louvre, 18" x 42"ID Oval, Closed Louvre /w 4/4" x 3 1/2" Frame	18	42	\$ 99.43
	LPC1C-22(48)	Prestige PVC Louvre, 22" x 48"ID Oval, Closed Louvre /w 4/4" x 3 1/2" Frame	22	48	\$ 116.08
 <p><u>TRIANGLE</u></p>	LPC3F-12(48)	Prestige PVC Louvre, 12" x 24" Triangle, Closed Louvre /w Brick Mould Surround & Sill	12	48	\$ 43.46
	LPC3F-16(48)	Prestige PVC Louvre, 16" x 36" Triangle Rectangle, Closed Louvre /w Brick Mould Surround & Sill	16	48	\$ 63.15
	LPC3F-20(48)	Prestige PVC Louvre, 20" x 48" Triangle Rectangle, Closed Louvre /w Brick Mould Surround & Sill	20	48	\$ 97.35

**PRICES SUBJECT TO CHANGE WITHOUT NOTICE

HEIGHT	WIDTH											
	12	14	16	18	20	22	24	26	28	30	32	48
24	\$16.71	\$17.98	\$19.24	\$23.55	\$24.81	\$26.08	\$27.34	\$28.60	\$39.00	\$40.26	\$41.52	\$51.63
30	\$18.61	\$20.19	\$21.76	\$26.39	\$27.97	\$29.55	\$31.13	\$32.71	\$43.42	\$45.00	\$46.57	\$59.21
36	\$20.51	\$22.40	\$24.29	\$29.23	\$31.13	\$33.02	\$34.91	\$36.81	\$47.84	\$49.74	\$51.63	\$66.79
42	\$22.40	\$24.60	\$26.81	\$32.07	\$34.28	\$36.49	\$38.70	\$40.91	\$52.26	\$54.47	\$56.68	\$74.36
48	\$24.29	\$26.81	\$29.34	\$34.91	\$37.44	\$39.97	\$42.50	\$45.02	\$56.68	\$59.21	\$61.74	\$81.95
54	\$26.19	\$29.03	\$31.87	\$37.76	\$40.60	\$43.44	\$46.28	\$49.13	\$61.10	\$63.95	\$66.79	\$89.52
60	\$28.08	\$31.24	\$34.40	\$40.60	\$43.75	\$46.92	\$50.07	\$53.23	\$65.52	\$68.68	\$71.84	\$97.10
66	\$33.02	\$36.49	\$39.97	\$52.58	\$56.05	\$59.52	\$62.99	\$66.47	\$76.38	\$79.84	\$83.32	\$111.11
72	\$34.91	\$38.70	\$42.50	\$55.42	\$59.21	\$62.99	\$66.79	\$70.58	\$80.79	\$84.58	\$88.37	\$118.69
78	\$36.81	\$40.91	\$45.02	\$58.26	\$62.36	\$66.47	\$70.58	\$74.68	\$85.21	\$89.32	\$93.42	\$126.26
84	\$38.70	\$43.13	\$47.55	\$61.10	\$65.52	\$69.94	\$74.36	\$78.78	\$89.63	\$94.05	\$98.47	\$133.85
90	\$40.60	\$45.34	\$50.07	\$63.95	\$68.68	\$73.42	\$78.15	\$82.89	\$94.05	\$98.79	\$103.53	\$141.42
96	\$42.50	\$47.55	\$52.60	\$66.79	\$71.84	\$76.89	\$81.95	\$87.00	\$98.47	\$103.53	\$108.58	\$149.00
102	\$53.52	\$58.89	\$64.26	\$76.06	\$81.43	\$86.79	\$92.16	\$97.53	\$129.97	\$135.33	\$140.70	\$183.64
108	\$55.42	\$61.10	\$66.79	\$78.90	\$84.58	\$90.27	\$95.95	\$101.64	\$134.39	\$140.07	\$145.76	\$191.22
114	\$57.31	\$63.31	\$69.31	\$81.74	\$87.74	\$93.74	\$99.74	\$105.74	\$138.81	\$144.80	\$150.81	\$198.80
120	\$59.21	\$65.52	\$71.84	\$84.58	\$90.90	\$97.22	\$103.53	\$109.84	\$143.23	\$149.54	\$155.86	\$206.38

* ABOVE PRICES REFLECT FRAMELESS RECTANGLE LOUVRE

LOUVRE OPTIONS		SELECT	SELECTED OPTIONS
FRAMES	4/4" X 2" FRAME (4) - 50% Upcharge	<input type="checkbox"/>	
	BRICK MOULD (2) - 80% Upcharge	<input type="checkbox"/>	
	4/4" X 3 1/2" FRAME (6) - 100% Upcharge	<input type="checkbox"/>	
	4/4" X 5 1/2" FRAME (8) - 110% Upcharge	<input type="checkbox"/>	
	BOTTOM SILL - 5% Upcharge	<input type="checkbox"/>	
PEAK TOPLOUVRE (LPCK) - 15% Upcharge	<input type="checkbox"/>		
TRIANGLE LOUVRE (LPCF) - 75% Upcharge	<input type="checkbox"/>		
1/2 TRIANGLE LOUVRE (LPCN) - 15% Upcharge	<input type="checkbox"/>		
ROUND LOUVRE (LPCA) - 75% Upcharge (Red #'s for Frameless Round Louvre)	<input type="checkbox"/>		
ARCH TOP LOUVRE (LPCH) - 25% Upcharge	<input type="checkbox"/>		
OVAL LOUVRE (LPCC) - 110% Upcharge	<input type="checkbox"/>		
PRICING INSTRUCTIONS			\$ -
PRICE	ENTER PRICE INTO BLUE CELL		

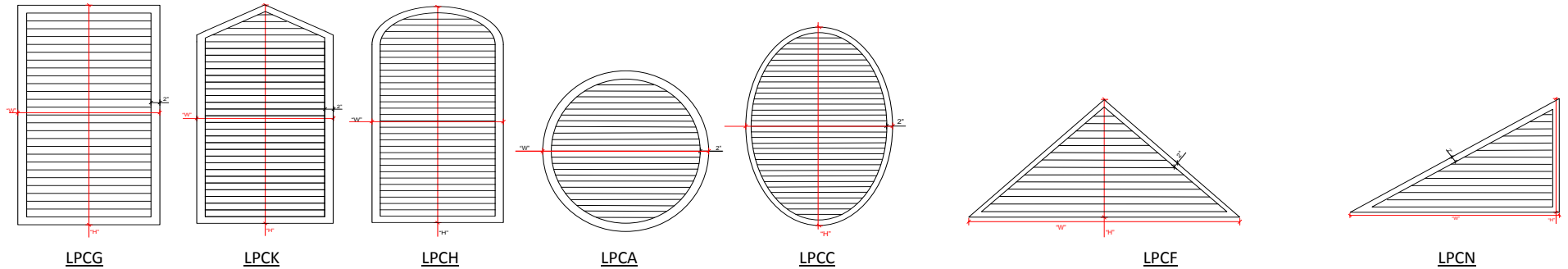
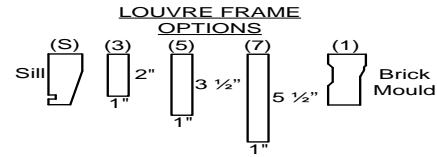

**PRICES SUBJECT TO CHANGE WITHOUT NOTICE

Assembly & Installation Instructions

Congratulations on your purchase of your new Prestige Gable™ Detail. These gables are designed to bring a classical architectural design to your home, and are engineered for easy installation. Before you begin your install, please take a few moments to unpack and review the contents of your package. Each Gable Detail will be installed behind the fascia board. You will need different fasteners depending on the application.

Note: The below installation instructions are suggested practices only. Fastener length may vary depending on product purchased. Ensure for 1" penetration into wood structure.

Materials Included:

- One (1) gable post with mounting block
- Two (2) gable stretchers
- Four (4), #8, 3" galvanized wood screws
- Three (3) screws per side of stretcher
- Two (2) space blocks for each stretcher **

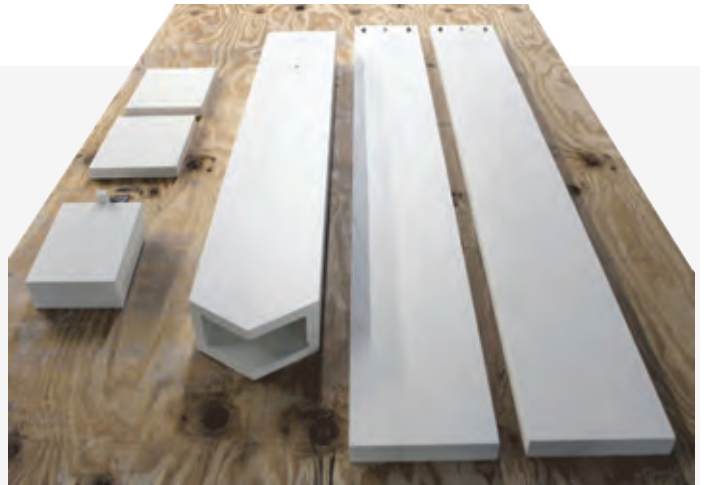

Gable Detail: Assembly



- On a clean flat surface, layout the gable detail parts.
- Using spacers to adjust the depth, place the two gable stretchers at the desired height from the bottom of the gable post or line up with pre marked holes.

It is recommended not to exceed 4" from the bottom of gable post.

- Using the #8 galvanized wood screws provided, toe screw the stretcher to the middle gable post. The holes are pre drilled for easy assembly.



- Fasten both stretchers to either side of the gable post.



Gable Detail: Installation Instructions

- Once the gable detail is assembled, remove the mounting block positioned in the gable post.

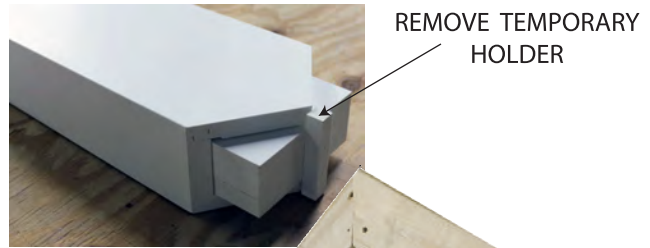

- Using the four (4) 3" #8 galvanized wood screws provided, fasten the mounting block to the top gable peak sub-fascia.

**** Best method is to screw two (2) from back of fascia and two (2) from the front.****



- Once mounting block is secured, with stretchers attached, slide gable post over block and fasten to the mounting block using four (4) 2" #8 galvanized wood screws. (Fasteners not included)



- Once gable post has been fastened to the mounting block, level post before fastening stretchers to sub fascia.



- Place block spacer (included) between stretcher and sub-fascia and using two (2) #8 galvanized wood screws, screw both into the back of the fascia, into the stretcher

- By screwing two (2) screws into both the front and back, you securely lock the gable into place both ways.



Congratulations, your Prestige Gable is now completely installed and ready to enjoy. While not required, your gable can be painted.



Innovative PVC Systems

www.prestigedi.com

PRESTIGE GABLES - 2017

IMPORTANT: * Standard Post widths and Stretcher heights are 3-1/2". ** Upgrade Post width and Stretcher height to 5-1/2" with 18% increase.
Note: (X) Indicates the selection of inverted 'T' or inverted 'C' profiles. (i.e. D1 or D7)

P R E S T I G E G A B L E S

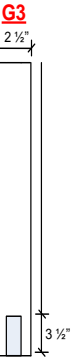
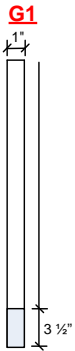

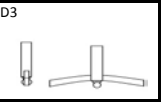
	(X)		PRODUCT CODE		DESCRIPTION	FORMAT	
	INVERTED "T" GABLES	INVERTED "C" GABLES	G1	G3		1" POST (G1)	2 1/2" POST (G3)
D1			G1i(X)b4145-72 G1i(X)b4148-96 G1i(X)b41411-144	G3i(X)b42.545-72 G3i(X)b42.548-96 G3i(X)b42.5412-144	Gable Detail - PVC, Inverted "T" or "Cross" @ 6' wide with ball (All Pitches) Gable Detail - PVC, Inverted "T" or "Cross" @ 8' wide with ball (All Pitches) Gable Detail - PVC, Inverted "T" or "Cross" @ 12' wide with ball (All Pitches) * Standard gable program designed to be cut to fit on-site if required	\$ 104.79 \$ 129.72 \$ 179.60	\$ 137.44 \$ 180.95 \$ 267.96
D2			G1i(X)4145-72 G1i(X)4148-96 G1i(X)41411-144	G3i(X)42.545-72 G3i(X)42.548-96 G3i(X)42.5411-144	Gable Detail - PVC, Inverted "T" or "Cross" @ 6' wide (All Pitches) Gable Detail - PVC, Inverted "T" or "Cross", @ 8' wide (All Pitches) Gable Detail - PVC, Inverted "T" or "Cross" @ 12' wide (All Pitches) * Standard gable program designed to be cut to fit on-site if required	\$ 75.26 \$ 100.20 \$ 150.07	\$ 107.91 \$ 151.42 \$ 238.43
D3			G1i(X)ab4145-72 G1i(X)ab4148-96 G1i(X)ab41411-144	G3i(X)ab42.545-72 G3i(X)ab42.548-96 G3i(X)ab42.5411-144	Gable Detail - PVC, Inverted "T" or "Cross", Arched @ 6' wide with ball (All Pitches) Gable Detail - PVC, Inverted "T" or "Cross", Arched @ 8' wide with ball (All Pitches) Gable Detail - PVC, Inverted "T" or "Cross", Arched, @ 12' wide with ball (All Pitches) * Standard gable program designed to be cut to fit on-site if required	\$ 133.87 \$ 160.74 \$ 214.49	\$ 197.84 \$ 224.71 \$ 278.46
D4			G1i(X)a4145-72 G1i(X)a4148-96 G1i(X)a41411-144	G3i(X)a42.545-72 G3i(X)a42.548-96 G3i(X)a42.5411-144	Gable Detail - PVC, Inverted "T" or "Cross", Arched @ 6' wide (All Pitches) Gable Detail - PVC, Inverted "T" or "Cross", Arched @ 8' wide (All Pitches) Gable Detail - PVC, Inverted "T" or "Cross", Arched @ 12' wide (All Pitches) * Standard gable program designed to be cut to fit on-site if required	\$ 111.63 \$ 136.38 \$ 184.28	\$ 168.31 \$ 195.19 \$ 248.93
D5			G1i(X)Vb4145-72 G1i(X)Vb4148-96 G1i(X)Vb41411-144	G3i(X)Vb42.545-72 G3i(X)Vb42.548-96 G3i(X)Vb42.5411-144	Gable Detail - PVC, Inverted "T" or "Cross" & "V" @ 6' wide with ball (All Pitches) Gable Detail - PVC, Inverted "T" or "Cross" & "V" @ 8' wide with ball (All Pitches) Gable Detail - PVC, Inverted "T" or "Cross" & "V" @ 12' wide with ball (All Pitches) * Standard gable program designed to be cut to fit on-site if required	\$ 136.88 \$ 152.51 \$ 183.78	\$ 220.92 \$ 236.56 \$ 267.82
D6			G1i(X)V4145-72 G1i(X)V4148-96 G1i(X)V41411-144	G3i(X)V42.545-72 G3i(X)V42.548-96 G3i(X)V42.5411-144	Gable Detail - PVC, Inverted "T" or "Cross" & "V" @ 6' wide (All Pitches) Gable Detail - PVC, Inverted "T" or "Cross" & "V" @ 8' wide (All Pitches) Gable Detail - PVC, Inverted "T" or "Cross" & "V" @ 12' wide (All Pitches) * Standard gable program designed to be cut to fit on-site if required	\$ 107.35 \$ 122.99 \$ 154.25	\$ 191.39 \$ 207.03 \$ 238.29
D13			G1i(X)Vab4145-72 G1i(X)Vab4148-96 G1i(X)Vab41411-144	G3i(X)Vab42.545-72 G3i(X)Vab42.548-96 G3i(X)Vab42.5411-144	Gable Detail - PVC, Inverted "T" or "Cross" & "V", Arched @ 6' wide with ball (All Pitches) Gable Detail - PVC, Inverted "T" or "Cross" & "V", Arched @ 8' wide with ball (All Pitches) Gable Detail - PVC, Inverted "T" or "Cross" & "V", Arched, @ 12' wide with ball (All Pitches) * Standard gable program designed to be cut to fit on-site if required	\$ 175.11 \$ 183.70 \$ 200.87	\$ 253.16 \$ 261.75 \$ 278.91
D14			G1i(X)Va4145-72 G1i(X)Va4148-96 G1i(X)Va41411-144	G3i(X)Va42.545-72 G3i(X)Va42.548-96 G3i(X)Va42.5411-144	Gable Detail - PVC, Inverted "T" or "Cross" & "V", Arched @ 6' wide (All Pitches) Gable Detail - PVC, Inverted "T" or "Cross" & "V", Arched @ 8' wide (All Pitches) Gable Detail - PVC, Inverted "T" or "Cross" & "V", Arched @ 12' wide (All Pitches) * Standard gable program designed to be cut to fit on-site if required	\$ 145.58 \$ 154.17 \$ 171.34	\$ 223.63 \$ 232.22 \$ 249.39

**PRICES SUBJECT TO CHANGE WITHOUT NOTICE

PRESTIGE GINGERBREADS - 2017

P
R
E
S
T
I
G
E

G
I
N
G
E
R
B
R
E
A
D
S

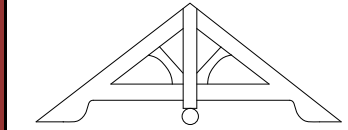

PRODUCT CODE
GDGB-23-07/12-72
GDGB-23-08/12-72
GDGB-23-09/12-72
GDGB-23-10/12-72
GDGB-23-11/12-72
GDGB-23-12/12-72

DESCRIPTION
Gable Gingerbread - 2" P x 7/12 Pitch, 72" Wide
Gable Gingerbread - 2" P x 8/12 Pitch, 72" Wide
Gable Gingerbread - 2" P x 9/12 Pitch, 72" Wide
Gable Gingerbread - 2" P x 10/12 Pitch, 72" Wide
Gable Gingerbread - 2" P x 11/12 Pitch, 72" Wide
Gable Gingerbread - 2" P x 12/12 Pitch, 72" Wide

STANDARD PRICE
\$ 216.69
\$ 234.03
\$ 252.74
\$ 272.97
\$ 294.80
\$ 318.39



GCGB101-667
GCGB101-865
GCGB101-1063
GCGB101-1272

Gable Detail - PVC - Gingerbread - Scroll 1, 1" P x 6/12 - 72"Wide
Gable Detail - PVC - Gingerbread - Scroll 1, 1" P x 8/12 - 65"Wide
Gable Detail - PVC - Gingerbread - Scroll 1, 1" P x 10/12 - 63"Wide
Gable Detail - PVC - Gingerbread - Scroll 1, 1" P x 12/12 - 72"Wide

\$ 146.16
\$ 158.51
\$ 179.42
\$ 258.07



GDGB102-660
GDGB102-857
GDGB102-1057
GDGB102-1272

Gable Detail - PVC - Gingerbread - Scroll 2, 1" P x 6/12 - 60"Wide
Gable Detail - PVC - Gingerbread - Scroll 2, 1" P x 8/12 - 57"Wide
Gable Detail - PVC - Gingerbread - Scroll 2, 1" P x 10/12 - 57"Wide
Gable Detail - PVC - Gingerbread - Scroll 2, 1" P x 12/12 - 72"Wide

\$ 167.59
\$ 175.50
\$ 202.42
\$ 271.69



GDGB103-665
GDGB103-860
GDGB103-1058
GDGB103-1272

Gable Detail - PVC - Gingerbread - Scallop /w Scroll, 1" P x 6/12 - 65
Gable Detail - PVC - Gingerbread - Scallop /w Scroll, 1" P x 8/12 - 60
Gable Detail - PVC - Gingerbread - Scallop /w Scroll, 1" P x 10/12 - 58
Gable Detail - PVC - Gingerbread - Scallop /w Scroll, 1" P x 12/12 - 72

\$ 187.24
\$ 208.45
\$ 222.82
\$ 312.55



GDGB104-660
GDGB104-857
GDGB104-1054
GDGB104-1272

Gable Detail - PVC - Gingerbread - Medallion 1, 1" P x 6/12 - 60
Gable Detail - PVC - Gingerbread - Medallion 1, 1" P x 8/12 - 57
Gable Detail - PVC - Gingerbread - Medallion 1, 1" P x 10/12 - 54
Gable Detail - PVC - Gingerbread - Medallion 1, 1" P x 12/12 - 72

\$ 158.72
\$ 161.88
\$ 163.87
\$ 258.07



GDGB105-664
GDGB105-860
GDGB105-1058
GDGB105-1272

Gable Detail - PVC - Gingerbread - Scroll 3, 1" P x 6/12 - 64"Wide
Gable Detail - PVC - Gingerbread - Scroll 3, 1" P x 8/12 - 60"Wide
Gable Detail - PVC - Gingerbread - Scroll 3, 1" P x 10/12 - 58"Wide
Gable Detail - PVC - Gingerbread - Scroll 3, 1" P x 12/12 - 72"Wide

\$ 150.63
\$ 168.75
\$ 186.88
\$ 271.69



GDGB106-667
GDGB106-864
GDGB106-1061
GDGB106-1272

Gable Detail - PVC - Gingerbread - Owl Scroll, 1" P x 6/12 - 67"Wide
Gable Detail - PVC - Gingerbread - Owl Scroll, 1" P x 8/12 - 64"Wide
Gable Detail - PVC - Gingerbread - Owl Scroll, 1" P x 10/12 - 61"Wide
Gable Detail - PVC - Gingerbread - Owl Scroll, 1" P x 12/12 - 72"Wide

\$ 149.21
\$ 165.33
\$ 178.90
\$ 271.69



GDGB107-662
GDGB107-860
GDGB107-1058
GDGB107-1272

Gable Detail - PVC - Gingerbread - Marine Scroll, 1" P x 6/12 - 62"Wide
Gable Detail - PVC - Gingerbread - Marine Scroll, 1" P x 8/12 - 60"Wide
Gable Detail - PVC - Gingerbread - Marine Scroll, 1" P x 10/12 - 58"Wide
Gable Detail - PVC - Gingerbread - Marine Scroll, 1" P x 12/12 - 72"Wide

\$ 147.23
\$ 163.06
\$ 186.87
\$ 271.69

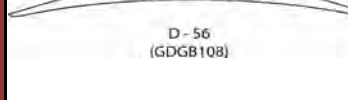

GDGB108-670
GDGB108-865
GDGB108-1062
GDGB108-1272

Gable Detail - PVC - Gingerbread - Butterfly, 1" P x 6/12 - 70"Wide
Gable Detail - PVC - Gingerbread - Butterfly, 1" P x 8/12 - 65"Wide
Gable Detail - PVC - Gingerbread - Butterfly, 1" P x 10/12 - 62"Wide
Gable Detail - PVC - Gingerbread - Butterfly, 1" P x 12/12 - 72"Wide

\$ 134.75
\$ 143.79
\$ 170.99
\$ 258.07

****PRICES SUBJECT TO CHANGE WITHOUT NOTICE**

PRESTIGE PLANTERS - 2017

PRICE LEVEL
STOCKING

P
R
E
S
T
I
G
E

P
L
A
N
T
E
R
S

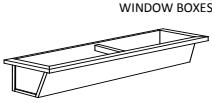

WINDOW BOXES

PRODUCT CODE	DESCRIPTION	NATURAL FINISH	PRE-FINISHED
PPW14	Flower -PVC-Window Box - 4'	\$ 89.63	\$ 116.53
PPW15	Flower -PVC-Window Box - 5'	\$ 112.49	\$ 146.24
PPW16	Flower -PVC-Window Box - 6'	\$ 134.89	\$ 175.36
PPW17	Flower -PVC-Window Box - 7'	\$ 157.30	\$ 204.48
PPW18	Flower -PVC-Window Box - 8'	\$ 179.24	\$ 233.01

#1



PPFL-CFMNTP-12	Flower -PVC-Planter Box /w Craftsman Edge Top - 12" x 12" x 12"	\$ 40.05	\$ 52.07
PPFL-CFMNTP-16	Flower -PVC-Planter Box /w Craftsman Edge Top - 16" x 16" x 16"	\$ 76.88	\$ 99.94
PPFL-CFMNTP-18	Flower -PVC-Planter Box /w Craftsman Edge Top - 18" x 18" x 18"	\$ 83.72	\$ 108.84
PPFL-CFMNTP-22	Flower -PVC-Planter Box /w Craftsman Edge Top - 22" x 22" x 22"	\$ 99.81	\$ 129.76
PPFL-CFMNTP-28	Flower -PVC-Planter Box /w Craftsman Edge Top - 28" x 28" x 28"	\$ 146.36	\$ 190.27

#2



PPFL-SHNGCB-18	Flower -PVC-Planter Box /w Shingle Cap & Base - 18" x 18" x 18"	\$ 108.04	\$ 140.46
PPFL-SHNGCB-22	Flower -PVC-Planter Box /w Shingle Cap & Base - 22" x 22" x 22"	\$ 137.28	\$ 178.47
PPFL-SHNGCB-28	Flower -PVC-Planter Box /w Shingle Cap & Base - 28" x 28" x 28"	\$ 218.01	\$ 283.41
PPFL-SHNGCB-1836	Flower -PVC-Planter Box /w Shingle Cap & Base - 18" x 18" x 36"	\$ 183.26	\$ 238.24
PPFL-SHNGCB-1848	Flower -PVC-Planter Box /w Shingle Cap & Base - 18" x 18" x 48"	\$ 225.07	\$ 292.59
PPFL-SHNGCB-1860	Flower -PVC-Planter Box /w Shingle Cap & Base - 18" x 18" x 60"	\$ 261.69	\$ 340.19

#3



PPFL-RSSHNG-18	Flower -PVC- Recessed Square Edge Planter Box /w Shingle Mould Cap/w Trim & Base - 18" x 18" x 18"	\$ 146.30	\$ 190.19
PPFL-RSSHNG-22	Flower -PVC- Recessed Square Edge Planter Box /w Shingle Mould Cap/w Trim & Base - 22" x 22" x 22"	\$ 179.47	\$ 233.32
PPFL-RSSHNG-2236	Flower -PVC- Recessed Square Edge Planter Box /w Shingle Mould Cap/w Trim & Base - 22" x 22" x 36"	\$ 257.91	\$ 335.29
PPFL-RSSHNG-2248	Flower -PVC- Recessed Square Edge Planter Box /w Shingle Mould Cap/w Trim & Base - 22" x 22" x 48"	\$ 306.10	\$ 397.92
PPFL-RSSHNG-2260	Flower -PVC- Recessed Square Edge Planter Box /w Shingle Mould Cap/w Trim & Base - 22" x 22" x 60"	\$ 352.95	\$ 458.84

#4



PPFL-RSX-18	Flower -PVC- Planter Box /w Applied "X" - 18" x 18" x 18"	\$ 158.82	\$ 206.47
PPFL-RSX-22	Flower -PVC- Planter Box /w Applied "X" - 22" x 22" x 22"	\$ 196.70	\$ 255.70
PPFL-RSX-2236	Flower -PVC- Planter Box /w Applied "X" - 22" x 22" x 36"	\$ 269.45	\$ 350.28
PPFL-RSX-2248	Flower -PVC- Planter Box /w Applied "X" - 22" x 22" x 48"	\$ 331.83	\$ 431.38
PPFL-RSX-2260	Flower -PVC- Planter Box /w Applied "X" - 22" x 22" x 60"	\$ 394.19	\$ 512.45

PLAIN PLANTERS



PPF1BD	Planter-PVC-Floor-Plain Panel - 12"W x 17"H	\$ 57.20	\$ 74.36
PPF1AE	Planter-PVC-Floor-Plain Panel - 11"W x 19"H	\$ 56.76	\$ 73.79

RAISED PANEL PLANTERS

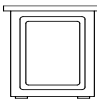

PPF3BD	Planter-PVC-Floor-Raised Panel - 12"W x 17"H	\$ 73.76	\$ 95.89
PPF3AE	Planter-PVC-Floor-Raised Panel - 11"W x 19"H	\$ 73.36	\$ 95.36

PLANTER STANDS

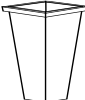

PPS913(42)	Planter-PVC-Stand - 9" - 13" x 42" Tapered	\$ 158.59	\$ 206.17
PPS913(60)	Planter-PVC-Stand - 9" - 13" x 60" Tapered	\$ 199.07	\$ 258.80
PPST	PVC Cocktail Table Square Top - 1/2" x 18 3/4" x 18 3/4"	\$ 26.75	\$ 34.79
PPSQ	PVC Cocktail Table Oval Top - 1/2" x 23" x 35"	\$ 39.59	\$ 51.47
PPSR	PVC Cocktail Table Round Top - 1/2" x 23" x 35"	\$ 26.75	\$ 34.79

**PRICES SUBJECT TO CHANGE WITHOUT NOTICE



P
R
E
S
T
I
G
E

C
O
R
N
I
C
E

PRESTIGE PLANTERS - 2017

PRICE LEVEL
STOCKING



	PRODUCT CODE	DESCRIPTION	NATURAL FINISH	PRE-FINISHED
12' PRESTIGE CORNICE	FB-PSCB-58(0612)	Cornice - PVC, Solid Crown/Base Cap, 5/8" x 6" x 12'	\$ 63.63	\$ 79.55
	FB-PSCB-58(0812)	Cornice - PVC, Solid Crown/Base Cap, 5/8" x 8" x 12'	\$ 84.83	\$ 106.05
	FB-PSCB-58(1012)	Cornice - PVC, Solid Crown/Base Cap, 5/8" x 10" x 12'	\$ 95.69	\$ 119.62
	FB-PSCB-58(1212)	Cornice - PVC, Solid Crown/Base Cap, 5/8" x 12" x 12.	\$ 106.62	\$ 133.27
	FB-C-38(2.512)	Cornice - PVC, Top Cap, 3/8" x 2 1/2" x 12'	\$ 9.39	\$ 11.73
16' PRESTIGE CORNICE	FB-PSCB-58(0616)	Cornice - PVC, Solid Crown/Base Cap, 5/8" x 6" x 16'	\$ 84.84	\$ 106.06
	FB-PSCB-58(0816)	Cornice - PVC, Solid Crown/Base Cap, 5/8" x 8" x 16'	\$ 113.11	\$ 141.39
	FB-PSCB-58(1016)	Cornice - PVC, Solid Crown/Base Cap, 5/8" x 10" x 16'	\$ 127.59	\$ 159.49
	FB-PSCB-58(1216)	Cornice - PVC, Solid Crown/Base Cap, 5/8" x 12" x 16'	\$ 142.16	\$ 177.70
	FB-C-38(2.516)	Cornice - PVC, Top Cap, 3/8" x 2 1/2" x 16'	\$ 12.51	\$ 15.64
4' PRESTIGE "EASY FIT" CORNICE	FB-PSCB(e)-58(0604)	Cornice "Easy Fit" - PVC, Solid Crown/Base Cap, 5/8" x 6" x 4'	\$ 25.45	\$ 31.81
	FB-PSCB(e)-58(0804)	Cornice "Easy Fit" - PVC, Solid Crown/Base Cap, 5/8" x 8" x 4'	\$ 33.93	\$ 42.41
	FB-PSCB(e)-58(1004)	Cornice "Easy Fit" - PVC, Solid Crown/Base Cap, 5/8" x 10" x 4'	\$ 38.28	\$ 47.85
	FB-PSCB(e)-58(1204)	Cornice "Easy Fit" - PVC, Solid Crown/Base Cap, 5/8" x 12" x 4'	\$ 42.65	\$ 53.31
	FB-C-38(2.504)	Decor Cornice - PVC, Top Cap, 3/8" x 2 1/2" x 4'	\$ 3.76	\$ 4.69
8' PRESTIGE "EASY FIT" CORNICE	FB-PSCB-58(0608)	Cornice - PVC, Solid Crown/Base Cap, 5/8" x 6" x 8'	\$ 50.91	\$ 63.63
	FB-PSCB(e)-58(0808)	Cornice "Easy Fit" - PVC, Solid Crown/Base Cap, 5/8" x 8" x 8'	\$ 67.86	\$ 84.83
	FB-PSCB(e)-58(1008)	Cornice "Easy Fit" - PVC, Solid Crown/Base Cap, 5/8" x 10" x 8'	\$ 76.56	\$ 95.69
	FB-PSCB(e)-58(1208)	Cornice "Easy Fit" - PVC, Solid Crown/Base Cap, 5/8" x 12" x 8'	\$ 85.30	\$ 106.62
	FB-C-38(2.508)	Decor Cornice - PVC, Top Cap, 3/8" x 2 1/2" x 8'	\$ 7.51	\$ 9.39

****PRICES SUBJECT TO CHANGE WITHOUT NOTICE**

PRESTIGE BRACKETS - 2017

P
R
E
S
T
I
G
E

B
R
A
C
K
E
T
S



PRODUCT CODE	DESCRIPTION	STANDARD PACKAGE
GBP-2411-1 GBP-2411-2	PVC - Bracket - 16" x 8" x 3" PVC - Bracket - 18" x 8" x 3"	\$ 59.75 \$ 61.10 \$ - \$ -
GBP-2480-1 GBP-2480-2	PVC - Bracket - 23 1/2" x 23 1/2" x 4" PVC - Bracket - 33" x 29" x 5"	\$ 68.03 \$ 69.42 \$ - \$ -
GBP-2520	PVC - Bracket - 39" x 37" x 5 1/2"	\$ 123.99 \$ - \$ - \$ -
GBP-2558-1 GBP-2558-2	PVC - Bracket - 15" x 13" x 4" PVC - Bracket - 23" x 19" x 4"	\$ 66.61 \$ 78.71 \$ - \$ -
GBP-2567-1 GBP-2567-2 GBP-2567-1-S GBP-2567-2-S	PVC - Bracket - 32" x 40" x 5" PVC - Bracket - 24" x 34" x 5" PVC - Bracket - 32" x 40" x 5" /w Structural Metal Support PVC - Bracket - 24" x 34" x 5" /w Structural Metal Support	\$ 192.37 \$ 159.26 \$ 268.57 \$ 235.46
GBP-2588 GBP-2588-2 GBP-2588-3	PVC - Bracket - 9"P x 5"H x 2 3/4"W PVC - Bracket - 24"P x 5"H x 5"W PVC - Bracket - 40"P x 5"H x 5"W	\$ 29.25 \$ 136.17 \$ 226.95 \$ -
GBP-2614-1 GBP-2614-2	PVC - Bracket - 18" x 16" x 5" PVC - Bracket - 33" x 29" x 5"	\$ 72.91 \$ 103.33 \$ - \$ -
GBP-2701	PVC - Bracket - 22" x 22" x 3 1/2"	\$ 69.08 \$ - \$ - \$ -
GBP-2832	PVC - Bracket - 30" x 60" x 7 1/4"	\$ 161.80 \$ - \$ - \$ -
GBP-2948-1 GBP-2948-2 GBP-2948-1-S GBP-2948-2-S	PVC - Bracket - 32" x 40" x 5" PVC - Bracket - 24" x 34" x 5" PVC - Bracket - 32" x 40" x 5" /w Structural Metal Support PVC - Bracket - 24" x 34" x 5" /w Structural Metal Support	\$ 192.37 \$ 159.26 \$ 268.57 \$ 235.46
GBP-5400	Bracket-PVC, Stepped Bracket /w Coved Steps & Full Round Detail 5"W x 12 1/4"P x 27 1/4"H	\$ 230.47 \$ - \$ - \$ -
GBP-5500	Bracket-PVC, Porch Bracket /w Scroll Detail 12" x 12"	\$ 41.92 \$ - \$ - \$ -
GBP-5600 GBP-5610 GBP-5620	PVC - Bracket - 14" x 14" x 4" PVC - Bracket - 20" x 20" x 4" PVC - Bracket - 24" x 24" x 5 1/2"	\$ 53.61 \$ 63.60 \$ 69.84 \$ -

P
R
E
S
T
I
G
E

B
R
A
C
K
E
T
S



GBP-2650

Bracket - PVC, 24"h x 21"p x 6"w- Top Closed

\$ 123.52
\$ -
\$ -
\$ -



GBP-5800

PVC - Bracket - 13 1/2" x 13 1/2" x 3"

\$ 64.34
\$ -
\$ -
\$ -



GBP-5900

PVC - Bracket - 31" x 19" x 4"

\$ 126.60
\$ -
\$ -
\$ -



GBP-6000

PVC - Bracket - 15" x 15" x 6"

\$ 49.24
\$ -
\$ -
\$ -



GBP-6100

PVC - Bracket - 15 3/4" x 10 3/4" x 4"

\$ 55.39
\$ -
\$ -
\$ -



GBP-6200

PVC - Bracket - 22" x 14" x 4"

\$ 64.40
\$ -
\$ -
\$ -



GBP-6300

PVC - Bracket - 11 1/2" x 11 1/2" x 3"

\$ 55.13
\$ -
\$ -
\$ -



GBP-6400

PVC - Bracket - 15 1/2" x 15 1/2" x 5 1/4"

\$ 60.15
\$ -
\$ -
\$ -

**PRICES SUBJECT TO CHANGE WITHOUT NOTICE