



## 2017 PRICE BOOK

**Prestige DIY Products are perhaps the finest PVC systems available for your home.**

Constructed from premium quality PVC, these products have been beautifully designed and are *engineered to last.*

Prestige DIY Products™ offer the *elegant beauty* of traditional wood features, while being *virtually maintenance-free.* With the Prestige Advantage, you can expect to enjoy your product for as long as you own your home.

*The Prestige Products™ Advantage*

**Beautiful**

- Classic Architectural Look
- No Visible Fasteners
- Wide Assortment of Styles

**Easy Installation**

- Complete Kit, with Fasteners & Adhesive
- No Special Tools Needed
- Easy Innovative SmartLock™ Corners
- Flat-Pack for Safe & Easy Transportation

**Virtually Maintenance Free**

- Free-Foam Cellular PVC Construction
- Weather, Decay and Insect Resistant
- Paint Friendly with Acrylic Latex Paints



[www.prestigediy.com](http://www.prestigediy.com)



**PRESTIGE DIY PRODUCTS PRICES - 2017**



**P R E M I U M  
C O L U M N S T Y L E S**

S  
Q  
U  
A  
R  
E

- [PLAIN COLUMNS](#)
- [RAISED PANEL COLUMNS](#)
- [FLUTED PANEL COLUMNS](#)
- [RECESSED SQUARE EDGE COLUMNS](#)
- [RECESSED FLUSH TRIM COLUMNS](#)
- [RECESSED RAISED TRIM COLUMNS](#)
- [CAP & BASE OPTIONS](#)
- [CONFIRMATION DRAWING](#)

[FLEX COLUMNS](#)

T  
A  
P  
E  
R  
E  
D

- [PLAIN COLUMNS](#)
- [RAISED PANEL COLUMNS](#)
- [RECESSED SQUARE EDGE COLUMNS](#)
- [RECESSED FLUSH TRIM COLUMNS](#)
- [CAP & BASE OPTIONS](#)
- [CONFIRMATION DRAWING](#)

P  
R  
E  
M  
I  
U  
M

- [UNIQUE FLARE](#)
- [COCHREN FLARE \(12" SINGLE LATTICE\)](#)
- [COCHREN FLARE \(16" SINGLE LATTICE\)](#)
- [COCHREN FLARE \(24" SINGLE LATTICE\)](#)
- [COCHREN FLARE \(12" DOUBLE LATTICE\)](#)
- [COCHREN FLARE \(16" DOUBLE LATTICE\)](#)
- [COCHREN FLARE \(24" DOUBLE LATTICE\)](#)
- [PREMIUM PREVIEW](#)
- [PREMIUM STYLES](#)



G  
A  
B  
L  
E  
S

- [STANDARD GABLE PRICE PAGE](#)
- [GABLE BUILDER / COMING SOON](#)
- [GINGERBREADS](#)



L  
O  
U  
V  
R  
E  
S

- [CLOSED LOUVRE PREVIEW](#)
- [CLOSED LOUVRE](#)



S  
H  
U  
T  
T  
E  
R  
S

- [DECOR COLLECTION SHUTTERS](#)
- [DISTINCTIVE COLLECTION SHUTTERS](#)
- [FLEX SHUTTERS](#)
- [SHUTTER HARDWARE](#)
- [SHUTTER POLICY](#)
- [SHUTTER BROCHURE](#)



N  
E  
W  
A  
L  
S

- [PRESTIGE NEWAL POSTS](#)
- [PRESTIGE PLINTH BOXES](#)



S  
O  
F  
F  
I  
T

- [PRESTIGE SOFFIT](#)



B  
R  
A  
C  
K  
E  
T  
S

- [PRESTIGE BRACKETS](#)



P  
L  
A  
N  
T  
E  
R  
S

- [PRESTIGE PLANTERS](#)



C  
O  
R  
N  
I  
C  
E

- [PRESTIGE CORNICE](#)



L  
I  
N  
K  
S

- [PRESTIGE COLUMNS INSTALLATION](#)
- [PRESTIGE GABLES ASSEMBLY](#)
- [PRESTIGE GABLES INSTALLATION](#)
- [PAINT OPTIONS](#)
- [PAINT SPECS](#)
- [PRESTIGE WARRANTY](#)





## LIMITED WARRANTY - PRESTIGE DIY PRODUCTS™

1357042 Ontario Limited (hereinafter "Décor Innovations") warrants to the original consumer purchaser (the "Original Consumer Purchaser") and only to the extent set forth below, its successor and assign (together with the Original Consumer Purchaser, the "Consumer Purchaser"), subject to the terms and conditions herein, that each PRESTIGE DIY PRODUCTS™ Product, as shipped, will be free from manufacturing defects that cause the Product to delaminate, decay, rot, corrode or swell excessively from moisture for a period of thirty (30) years from the date of the original purchase from an authorized PRESTIGE DIY PRODUCTS™ dealer (the "Original Purchase Date"). Each Consumer Purchaser of PRESTIGE DIY PRODUCTS™ shall have sole responsibility for making determinations as to the suitability, effectiveness, and safety of any particular use or application of the PRESTIGE DIY PRODUCTS™. As building code regulations may vary from area to area, each Consumer Purchaser should consult local building and safety codes for specific requirements.

Value added paint options come with a 1 year limited warranty.

### ADDITIONAL CONDITIONS AND EXCEPTIONS

In all events, Décor Innovation's sole and exclusive liabilities under this warranty are limited solely and exclusively to replacement of defective PRESTIGE DIY PRODUCTS™, or the issuance of a refund equal to the original cost of the PRESTIGE DIY PRODUCTS™. Under no circumstances shall Décor Innovations be liable for labour, installation, reinstallation, freight, taxes or any other charge related to defective PRESTIGE DIY PRODUCTS™. Décor Innovations shall not be liable under any circumstances for any indirect, incidental, punitive, consequential, exemplary or other damages of any kind whatsoever, whether any such claim is based upon theories of contract, warranty, negligence, tort strict liability or otherwise. This warranty does not provide protection against any failure of, defect in or damage to PRESTIGE DIY PRODUCTS™ caused by situations beyond normal exposure conditions, including but not limited to the following: intentional or unintentional misuse, abuse, neglect, or improper handling or storage; impact of foreign objects; earthquake, lightning, ice, fire, tornado, windstorm, flood, among others or any other acts of God; improper installation of the PRESTIGE DIY PRODUCTS™ or its structural supports, or installation not in strict adherence to Décor Innovation's written instructions; cracking, distortion, movement, settlement, or warping of the PRESTIGE DIY PRODUCTS™ structural supports or accessories used in connection therewith; insurrection, terrorism, acts of war, riot, vandalism, improper maintenance, use of incompatible accessories; or other products that cause a PRESTIGE DIY PRODUCTS™ defect or failure to occur; pollution, acid rain, contact with harmful chemicals or vapors; or ordinary and expected weathering due to exposure to the elements; which for purposes of this Warranty is defined to be fading, chalking or darkening of the surface of the Product due to exposure to natural sunlight and extreme atmospheric conditions that are unique to and may vary depending on geographic location. Décor Innovations shall have sole discretion to determine, based on reasonable criteria, whether the PRESTIGE DIY PRODUCTS™ is suffering from normal weathering. This Warranty does not cover painted finishes or coating applied to PRESTIGE DIY PRODUCTS™ by the Consumer Purchaser or any third party. Failure to adhere to Décor Innovation's recommended guidelines for application of painted surfaces shall void this Warranty. All claims under this Limited Warranty must be made within 90 days from the time that the defect is discovered and while the PRESTIGE DIY PRODUCTS™ is in place. Consumer Purchaser shall provide Décor Innovations and its agents and employees with a reasonable opportunity to inspect and test the PRESTIGE DIY PRODUCTS™, its installation, and the environment in which the Consumer Purchaser used it prior to removal so that Décor Innovations may determine what replacement, if any, may be needed. In the event that Décor Innovations determines that a replacement is appropriate, Décor Innovations shall have the option of retaining all material that is replaced. If Décor Innovations replaces any material under this warranty, it may substitute products designed by Décor Innovations to be of compatible quality or price range in the event that the product initially purchased has been discontinued or modified. Anything less than strict compliance with these notice and inspection provisions shall serve to void all warranties with regard to PRESTIGE DIY PRODUCTS™. This Warranty may not be altered or amended except in a written statement signed Décor Innovations and Consumer Purchaser. Décor Innovations has not authorized any dealer or other person to make statements or representations regarding the performance of PRESTIGE DIY PRODUCTS™ except as contained in this Warranty, and Décor Innovations shall not be bound by any such statements other than those contained herein.

THE FOREGOING WARRANTY IS EXCLUSIVE AND IN LIEU OF ANY AND ALL OTHER APPLICABLE WARRANTIES, EXPRESS OR IMPLIED, INCLUDING WITHOUT LIMITATION, ANY IMPLIED WARRANTY OF MERCHANTABILITY OR FITNESS FOR A PARTICULAR USE.

This Warranty is transferable to a successor by the Original Consumer Purchaser with the transfer of other conveyance of the PRESTIGE DIY PRODUCTS™ and shall not be transferable or assignable by any subsequent consumer purchaser. In accordance with the foregoing, this Warranty shall expire upon the first to occur of: (i) the transfer or other conveyance of the PRESTIGE DIY PRODUCTS™ by the Original Consumer Purchaser's successor or assign; or (ii) thirty (30) years from the Original Purchase Date.

























Some states and provinces do not permit limitations on the duration of implied warranties or exclusions or limitations of incidental or consequential damages, so certain limitations set forth in this Limited Warranty may not apply to you. This warranty gives you specific legal rights, and you may have other rights which may vary from state to state.

### FILING A WARRANTY CLAIM

To file a claim under this Warranty, Consumer Purchaser must send proof of purchase, a photograph of the defective PRESTIGE DIY PRODUCTS™ and a written description of the nature of the defect to the company's corporate address in Oakville, ON. (See address below). Décor Innovations reserves the right to investigate any claim hereunder. Upon verification of the claim, Décor Innovations shall, at its sole discretion, either arrange for the delivery of replacement Product or issue a refund equal to the original cost of the Product only. In either instance, Consumer Purchaser shall allow Décor Innovations at least ninety (90) days for investigation and either replacement or refund.

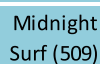

**Stock Colours**

		EURO FINISH					
LIGHT COLOURS (LRV 56 - 100)	Benjamin Moore Colours						
	Tan AF-80	Mascarpone AF-20	White 2131-70	CornSilk CC-218	Sandalwood 273	Horizon OC-53	
							
	Gentek Colours						
	Almond (532)	Sandstone (540)	Bright White (431)	Maize (502)	Sandalwood (508)	Pearl (534)	
							
DARK COLOURS (LRV 0 - 55)	Benjamin Moore Colours						
	Clay AF-155	Commercial Brown 2139-10	Black 2127-10	Blue HC-159	High Park 467	Escarpment CC-518	
							
	Gentek Colours						
	Pebble (559)	Commercial Brown (562)	Midnight Surf (509)	Wedgewood Blue (535)	Sable (547)	Storm (570)	
							

**\* Custom Colours & Stains**  
Custom surcharge will apply  
Speak with your PrestigeDIY  
Representative for more information.

**Stock Paint:** 30% Surcharge on  
Material Value

**Dark Colours**  
\* Dark Colour Paints have  
heat reflective qualities.

Standard **EURO FINISH** on all  
dark painted products.

**Stock Stains**



Cherry  
DD#9571



Teak  
DD#9512



Espresso  
DD#9575



Mahogany  
DD#9509

**Stain Finishes on  
Prestige DIY Products!**

**Stock Stain:** 45% Surcharge on  
Material Value with Top Clear Coat



Espresso Stain

**Note:** Colours may vary from above chart. All colours to be signed off on before production.

**5 Year Limited Paint Warranty.**

For further information please visit us at [prestigediy.com](http://prestigediy.com)

## Preparation & Application

*Your Prestige DIY Products™ are manufactured using premium free-foam cellular PVC and do not require painting to validate the warranty. If painting is preferred, please use the guidelines below.*

### Surface Preparation

Prestige DIY Products™ can be painted to achieve the desired look or accent colour of your home. To ensure good paint adhesion, the surface of the pvc product should be clean, dry, and free of dirt, mildew, chalk, grease and any other surface contaminants before paint application. Prior to cleaning it is a good practice to fill any holes and remove any marks or blemishes that may appear during the installation process with an exterior filler, (for example, sandable Bondo).

Cleaning can be accomplished using a cloth and a mixture of mild detergent and water. Other cleaning agents include a mild household spray cleaner, a degreaser, or alcohol.

### Coating Specification

A 100% acrylic latex or 100% acrylic latex with a urethane additive should be used to achieve superior coating durability and flexibility. Only light to medium coloured paints with a light reflective value (LRV) of 55 units or greater should be applied to Prestige DIY Products™. *Using a paint with a LRV below 55 units will void our product warranty.*

Paint manufacturer recommendations include priming with an exterior 100% acrylic latex primer, followed by two coats of exterior 100% acrylic latex satin finish paint.

### Application

Apply paint when the air and surface temperatures are 2°C (35°F) or above, and when the air and surface temperatures will remain above this temperature for the next 24 hours. Avoid painting early in the morning or late in the day when dew and condensation are likely to form, or when rain or snow is threatening. To prolong the shelf life of the paint, always protect it from freezing.

Apply primer and topcoats using the following methods:

- Brush: Use a nylon/polyester brush.
- Roller: Use a 3/8" – 3/4" nap synthetic roller.
- Spray: Airless Pressure...2000 psi Tip...015"-019"

Typical Drying Times (Dry Time at 25°C (77°F); 50% Relative Humidity):

- To the Touch: 30 minutes - To Recoat: 4 hours
- To Handle: 1 hour - To Full Cure: 30 days

### Considerations

- Higher quality paints typically outperform lower quality paints.
- Temperature, humidity, wind, and the amount of direct sunlight at time of application will affect paint drying times.
- Prestige Products™ are impermeable to moisture; it may take as long as 45 days for paint application to fully cure.
- Paint failures on wood are due primarily to moisture cycling. Since Prestige Products™ cannot absorb moisture, paints will adhere better and for a much longer time when applied to premium PVC versus wood.

**Disclaimer:** Decor Innovations is not liable for paint used on Prestige DIY Products™ and/or the result of its use.



# CUSTOM STRAIGHT COLUMN LAYOUT

## CLIENT INFORMATION

Dealer Name: \_\_\_\_\_

Project: \_\_\_\_\_

PO#: \_\_\_\_\_

Project Contact: \_\_\_\_\_

Date: \_\_\_\_\_

Approved By: \_\_\_\_\_

## PANEL SIZES

1. Height (Y") \_\_\_\_\_

2. Width (X") \_\_\_\_\_

• Nominal   
• Actual

3. Inside Dims \_\_\_\_\_

4. Painted No   
Yes

Colour: \_\_\_\_\_

### REVEALS

R\* Top and Bottom Panel Reveals  
- 10" for columns 10' or less  
- 15" for columns 11' or greater

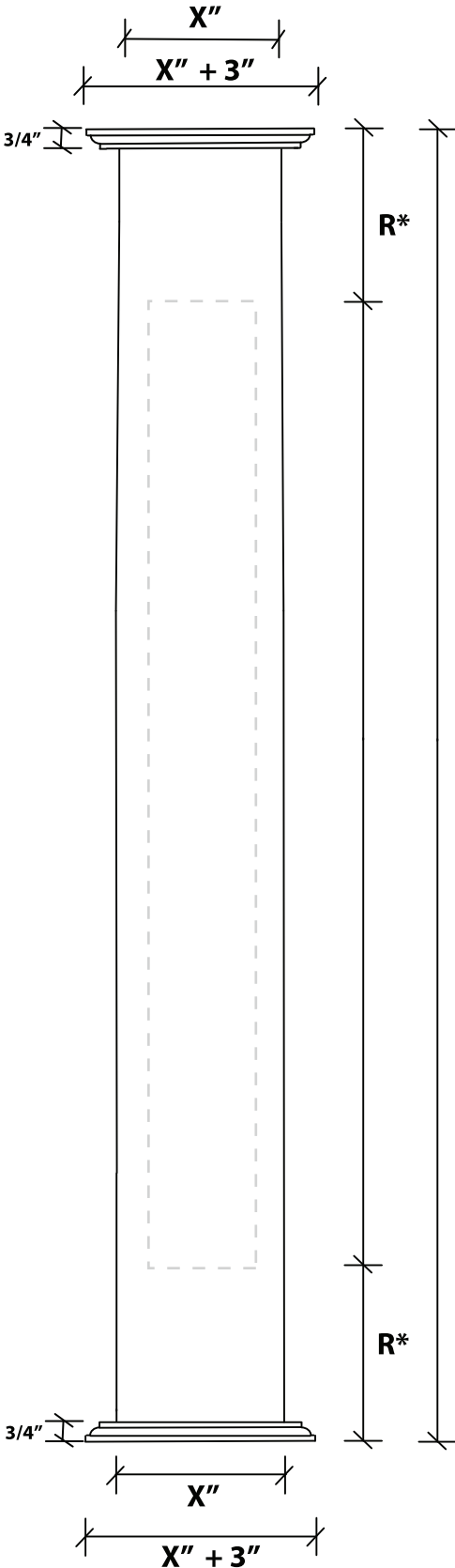

## PANEL PROFILE

- |                    |                          |
|--------------------|--------------------------|
| 1. Plain           | <input type="checkbox"/> |
| 2. Fluted          | <input type="checkbox"/> |
| 3. Raised          | <input type="checkbox"/> |
| 4. Recessed        | <input type="checkbox"/> |
| - Square Edge      | <input type="checkbox"/> |
| - Round Edge       | <input type="checkbox"/> |
| - w/ Base Cap Trim | <input type="checkbox"/> |
| - Flush Trim       | <input type="checkbox"/> |
| - Raised Trim      | <input type="checkbox"/> |

- |                    |                          |
|--------------------|--------------------------|
| 1. Single Panel    | <input type="checkbox"/> |
| 2. Double Panel    | <input type="checkbox"/> |
| 3. 1/3 - 2/3 Panel | <input type="checkbox"/> |
| 4. Custom _____    | <input type="checkbox"/> |

NOTES: \_\_\_\_\_

Panel Locks:  M  F

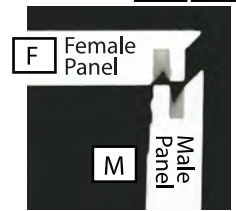

## CAPS & BASES

Craftsman

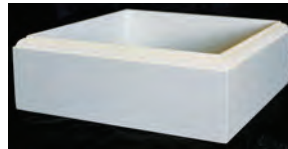

4" \_\_\_\_\_  
6" \_\_\_\_\_  
8" \_\_\_\_\_  
10" \_\_\_\_\_

Crown Mould



4" \_\_\_\_\_  
5" \_\_\_\_\_  
6" \_\_\_\_\_

Tuscan



5" \_\_\_\_\_  
6" \_\_\_\_\_  
8" \_\_\_\_\_  
10" \_\_\_\_\_

Place a 'T' for Column Top  
Place 'B' for Column Bottom

Chamfered



4" \_\_\_\_\_  
6" \_\_\_\_\_  
8" \_\_\_\_\_  
10" \_\_\_\_\_

Base Cap Edge



4" \_\_\_\_\_  
6" \_\_\_\_\_  
8" \_\_\_\_\_  
10" \_\_\_\_\_

Solid Crown



1. \_\_\_\_\_  
2. \_\_\_\_\_

# Prestige Column Sizes & Reveals - Straight Columns

Product Code	Prestige PVC Square Columns	Outside Dims. (inches)	Inside Dims. (inches)	Column Weight (lbs)
CPSPL-0808-096	Prestige Column - PVC, Square, Plain Panel, 8" x 8" x 8'	8" (7 1/4")	6 1/4"	40
CPSPL-0808-120	Prestige Column - PVC, Square, Plain Panel, 8" x 8" x 10'	8" (7 1/4")	6 1/4"	49
CPSPL-1010-096	Prestige Column - PVC, Square, Plain Panel, 10" x 10" x 8'	10" (9 3/8")	8 3/8"	49
CPSFL-0808-096	Prestige Column - PVC, Square, Fluted Panel, 8" x 8" x 8'	8" (7 1/4")	6 1/4"	40
CPSFL-0808-120	Prestige Column - PVC, Square, Fluted Panel, 8" x 8" x 10'	8" (7 1/4")	6 1/4"	49
CPSFL-1010-096	Prestige Column - PVC, Square, Fluted Panel, 10" x 10" x 8'	10" (9 3/8")	8 3/8"	49
CPSRA-0808-096	Prestige Column - PVC, Square, Raised Panel, 8" x 8" x 8'	8" (7 1/4")	6 1/4"	40
CPSRA-0808-120	Prestige Column - PVC, Square, Raised Panel, 8" x 8" x 10'	8" (7 1/4")	6 1/4"	49
CPSRA-1010-096	Prestige Column - PVC, Square, Raised Panel, 10" x 10" x 8'	10" (9 3/8")	8 3/8"	49
* CPSRS-0808-096	Prestige Column - PVC, Square, Recessed Panel - Square Edge, 8" x 8" x 8'	8" (7 1/4")	5-1/4"	40
* CPSRS-0808-120	Prestige Column - PVC, Square, Recessed Panel - Square Edge, 8" x 8" x 10'	8" (7 1/4")	5-1/4"	49
CPSRS-1010-096	Prestige Column - PVC, Square, Recessed Panel - Square Edge, 10" x 10" x 8'	10" (9 3/8")	7-3/8"	49
* CPSRB-0808-096	Prestige Column - PVC, Square, Recessed Panel Flush Trim - Base Cap Edge, 8" x 8" x 8'	8" (7 1/4")	5-1/4"	41
* CPSRB-0808-120	Prestige Column - PVC, Square, Recessed Panel Flush Trim - Base Cap Edge, 8" x 8" x 10'	8" (7 1/4")	5-1/4"	52
CPSRB-1010-096	Prestige Column - PVC, Square, Recessed Panel Flush Trim - Base Cap Edge, 10" x 10" x 8'	10" (9 3/8")	7-3/8"	52
* CPSRB-0808-096	Prestige Column - PVC, Square, Recessed Panel Raised Trim - Base Cap Edge, 8" x 8" x 8'	8" (7 1/4")	5-1/4"	41
* CPSRB-0808-120	Prestige Column - PVC, Square, Recessed Panel Raised Trim - Base Cap Edge, 8" x 8" x 10'	8" (7 1/4")	5-1/4"	52
CPSRB-1010-096	Prestige Column - PVC, Square, Recessed Panel Raised Trim - Base Cap Edge, 10" x 10" x 8'	10" (9 3/8")	7-3/8"	52

NOTE: \* Will Not Fit Around 6" x 6" PT Wood Structure.

Packaging- Standard Kit consists of boxed, 4 column panels, cap/base with adhesive strip, squaring corners, 2 oz. adhesive, fasteners, instructions.

## Prestige Panel Styles

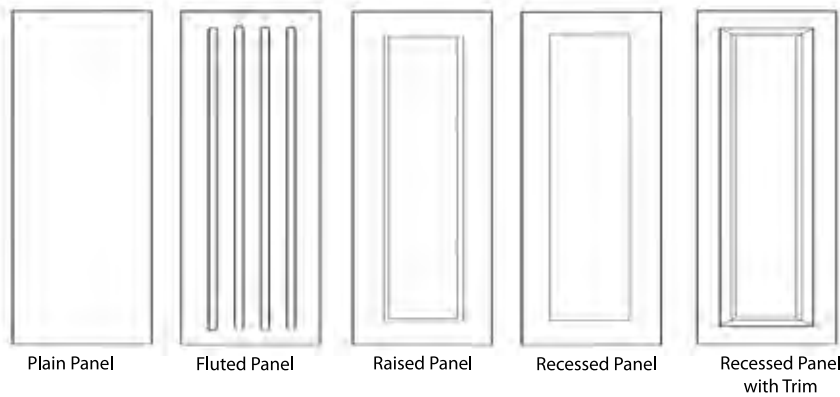

	Column Width (")	Outside Dims (")	Inside Dims (")		
			Plain, Fluted, Raised	Recessed Sq. Edge *	Recessed Base Cap *
1/2" Wall	6	5-1/2"	4-1/2"	3-1/2"	N/A
	8	7-1/4"	6-1/4"	5-1/4"	5-1/4"
	10	9-3/8"	8-3/8"	7-3/8"	7-3/8"
	12	11-1/4"	10"	9"	9"
5/8" Wall	14	13-1/4"	12"	11"	11"
	16	15-1/4"	14"	13"	13"
	18	17-1/4"	16"	15"	15"
	20	19-1/4"	18"	17"	17"
	22	21-1/4"	20"	19"	19"
	24	23-1/4"	22"	21"	21"

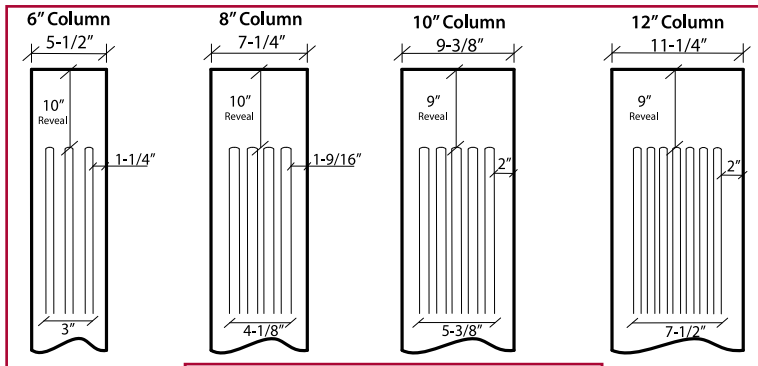

Reveals for Columns Under 10'

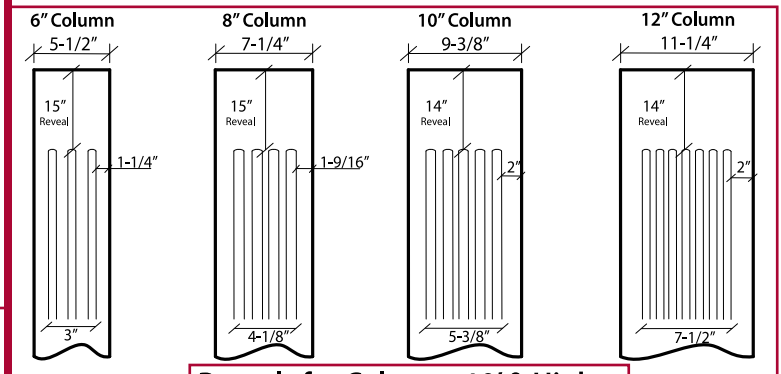

Reveals for Columns 10' & Higher

\* NOTE:

- For any column skirts above 6" in height, the column reveals will go to 14".
- 6" – 10" columns with square edge recessed panels will use either a 3/8" or a 1/2" thick backer panel.
- 12" columns and larger, with square edge recessed panels, will use a 1/2" thick backer panel.
- All columns with recessed panel with base cap trim will use a 5/8" thick column shaft and backer panel.

**PRESTIGE FLEX COLUMNS - 2017**

FLEX COLUMNS

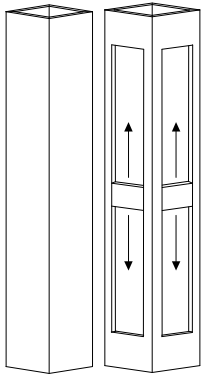

ADJUSTABLE 4" DIVIDER

\*Reveals match Standard Column Layouts

PRODUCT CODE	DESCRIPTION	FLEX PACKAGE (1PC)	FLEX PACKAGE (6PCS)	FLEX PACKAGE (24PCS)
<b>6" SQUARE COLUMNS</b>				
CPSPL-06096-FX	Column - PVC, Square, Plain, 6" @ 8'	\$ 207.55	\$ 195.35	\$ 183.14
CPSPL-06120-FX	Column - PVC, Square, Plain, 6" @ 10'	\$ 229.45	\$ 215.95	\$ 202.46
CSP-6FX	Skirt - PVC, Flex Skirt, 1" x 6"ID (1 Set - 4 L's)	\$ 13.25	\$ 12.47	\$ 11.69
<b>8" SQUARE COLUMNS</b>				
CPSPL-08096-FX	Column - PVC, Square, Plain, 8" @ 8'	\$ 199.56	\$ 187.82	\$ 176.08
CPSPL-08120-FX	Column - PVC, Square, Plain, 8" @ 10'	\$ 227.37	\$ 214.00	\$ 200.62
CSP-8FX	Skirt - PVC, Flex Skirt, 1" x 8"ID (1 Set - 4 L's)	\$ 12.57	\$ 11.83	\$ 11.09
<b>10" SQUARE COLUMNS</b>				
CPSPL-10096-FX	Column - PVC, Square, Plain, 10" @ 8'	\$ 228.32	\$ 214.89	\$ 201.45
CPSPL-10120-FX	Column - PVC, Square, Plain, 10" @ 10'	\$ 263.09	\$ 247.61	\$ 232.14
CSP-10FX	Skirt - PVC, Flex Skirt, 1" x 10"ID (1 Set - 4 L's)	\$ 16.90	\$ 15.91	\$ 14.92
<b>8" RECESSED SQUARE EDGE</b>				
CPSRS-08096-FX	Column - PVC, Square, Recessed Square Edge Panel, 8" @ 8'	\$ 265.24	\$ 249.64	\$ 234.03
CPSRS-08120-FX	Column - PVC, Square, Recessed Square Edge Panel, 8" @ 10'	\$ 307.06	\$ 289.00	\$ 270.93
CSP-8FX	Skirt - PVC, Flex Skirt, 1" x 8"ID (1 Set - 4 L's)	\$ 15.08	\$ 14.20	\$ 13.31
<b>10" RECESSED SQUARE EDGE</b>				
CPSRS-10096-FX	Column - PVC, Square, Recessed Square Edge Panel, 10" @ 8'	\$ 312.85	\$ 294.45	\$ 276.05
CPSRS-10120-FX	Column - PVC, Square, Recessed Square Edge Panel, 10" @ 10'	\$ 367.58	\$ 345.96	\$ 324.34
CSP-10FX	Skirt - PVC, Flex Skirt, 1" x 10"ID (1 Set - 4 L's)	\$ 16.90	\$ 15.91	\$ 14.92

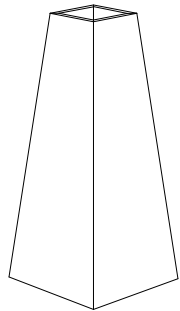

PRODUCT CODE	DESCRIPTION	1 PC	6 PCS	24 PCS
<b>12"-8" PLAIN TAPERED</b>				
CPTPL-1208048-FX	Column - PVC, Tapered, Plain Panel, 12"-8" @ 4'	\$ 166.40	\$ 156.61	\$ 146.83
CPTPL-1208060-FX	Column - PVC, Tapered, Plain Panel, 12"-8" @ 5'	\$ 183.13	\$ 172.36	\$ 161.59
CPTPL-1208072-FX	Column - PVC, Tapered, Plain Panel, 12"-8" @ 6'	\$ 199.87	\$ 188.11	\$ 176.35
CPTPL-1208096-FX	Column - PVC, Tapered, Plain Panel, 12"-8" @ 8'	\$ 233.33	\$ 219.61	\$ 205.88
CPTPL-1208120-FX	Column - PVC, Tapered, Plain Panel, 12"-8" @ 10'	\$ 266.80	\$ 251.11	\$ 235.42
CPTPL-1208144-FX	Column - PVC, Tapered, Plain Panel, 12"-8" @ 12'	\$ 300.36	\$ 282.69	\$ 265.02
CSP-1208FX	Skirt - PVC, Flex Skirt, 2 L's @ 1" x 12"ID & 2 L's @ 1" x 8"ID(1 Set)	\$ 16.90	\$ 15.91	\$ 14.92

ADHESIVE

ADHS-WO7052
-------------

Weld On705 WHITE 2 OZ Tube
----------------------------

1 PC	6 PCS	24 PCS
\$ 3.13	\$ 25.03	\$ 75.08

1"H x 1 1/2"W SQUARING SKIRT



\*Adds 3" to Outside Dims

SQUARE DIMS			TAPERED DIMS		
SIZE	OUTSIDE	INSIDE	SIZE	OUTSIDE	INSIDE
6"	5-1/2"	4-1/2"	12" - 8"	12"	8"
8"	7-1/4"	6-1/4"	SQUARE RECESSED PANEL DIMS		
10"	9-3/8"	8-3/8"	SIZE	OUTSIDE	INSIDE
			8"	7-1/4"	5-1/4"
			10"	9-3/8"	7-3/8"

**\*\*PRICES REFLECT 2 PC SHAFT, PACKAGED IN CLEAR PLASTIC FILM /W EDGE PROTECTORS & BAGGED**  
SOLD SEPARATELY: Adhesive, Fasteners & Squaring Skirt Sold in 1-6-24 Packs  
Square Column Recessed Panel /w 4" Adjustable Divider Set (Micro-Beveled Edges for alignment to Column Shaft)  
**\*PRICES SUBJECT TO CHANGE WITHOUT NOTICE**





**PRESTIGE COLUMNS - 2017**

PRICE LEVEL	
NON-STOCKING	
Standard C&B: 4" Craftsman	
CAP	4" Craftsman Skirt
BASE	4" Craftsman Skirt
<input checked="" type="checkbox"/> ADD CAP & BASE	

COLUMNS	PRODUCT CODE / SHAFT ONLY	PRODUCT CODE /w 4" SKIRTS	DESCRIPTION	1 PIECE	6 PIECE
	6"	CPSPL-06048 CPSPL-06060 CPSPL-06072 CPSPL-06096 CPSPL-06108 CPSPL-06120 CPSPL-06144	CPSPL-06048-4K CPSPL-06060-4K CPSPL-06072-4K CPSPL-06096-4K CPSPL-06108-4K CPSPL-06120-4K CPSPL-06144-4K	Column - PVC, Square, Plain, 6" @ 4' Column - PVC, Square, Plain, 6" @ 5' Column - PVC, Square, Plain, 6" @ 6' Column - PVC, Square, Plain, 6" @ 8' Column - PVC, Square, Plain, 6" @ 9' Column - PVC, Square, Plain, 6" @ 10' Column - PVC, Square, Plain, 6" @ 12'	\$ 203.49 \$ 215.53 \$ 227.57 \$ 251.69 \$ 263.74 \$ 275.81 \$ 299.97
8"	CPSPL-08048 CPSPL-08060 CPSPL-08072 CPSPL-08096 CPSPL-08108 CPSPL-08120 CPSPL-08144	CPSPL-08048-4K CPSPL-08060-4K CPSPL-08072-4K CPSPL-08096-4K CPSPL-08108-4K CPSPL-08120-4K CPSPL-08144-4K	Column - PVC, Square, Plain, 8" @ 4' Column - PVC, Square, Plain, 8" @ 5' Column - PVC, Square, Plain, 8" @ 6' Column - PVC, Square, Plain, 8" @ 8' Column - PVC, Square, Plain, 8" @ 9' Column - PVC, Square, Plain, 8" @ 10' Column - PVC, Square, Plain, 8" @ 12'	\$ 217.66 \$ 236.05 \$ 254.43 \$ 291.20 \$ 309.59 \$ 327.97 \$ 364.84	\$ 204.60 \$ 221.88 \$ 239.17 \$ 273.73 \$ 291.01 \$ 308.29 \$ 342.95
10"	CPSPL-10048 CPSPL-10060 CPSPL-10072 CPSPL-10096 CPSPL-10108 CPSPL-10120 CPSPL-10144	CPSPL-10048-4K CPSPL-10060-4K CPSPL-10072-4K CPSPL-10096-4K CPSPL-10108-4K CPSPL-10120-4K CPSPL-10144-4K	Column - PVC, Square, Plain, 10" @ 4' Column - PVC, Square, Plain, 10" @ 5' Column - PVC, Square, Plain, 10" @ 6' Column - PVC, Square, Plain, 10" @ 8' Column - PVC, Square, Plain, 10" @ 9' Column - PVC, Square, Plain, 10" @ 10' Column - PVC, Square, Plain, 10" @ 12'	\$ 240.38 \$ 263.36 \$ 286.34 \$ 332.30 \$ 355.28 \$ 378.26 \$ 424.34	\$ 225.95 \$ 247.55 \$ 269.16 \$ 312.36 \$ 333.96 \$ 355.56 \$ 398.88
12"	CPSPL-12048 CPSPL-12060 CPSPL-12072 CPSPL-12096 CPSPL-12108 CPSPL-12120 CPSPL-12144	CPSPL-12048-4K CPSPL-12060-4K CPSPL-12072-4K CPSPL-12096-4K CPSPL-12108-4K CPSPL-12120-4K CPSPL-12144-4K	Column - PVC, Square, Plain, 12" @ 4' Column - PVC, Square, Plain, 12" @ 5' Column - PVC, Square, Plain, 12" @ 6' Column - PVC, Square, Plain, 12" @ 8' Column - PVC, Square, Plain, 12" @ 9' Column - PVC, Square, Plain, 12" @ 10' Column - PVC, Square, Plain, 12" @ 12'	\$ 263.08 \$ 290.66 \$ 318.24 \$ 373.39 \$ 400.96 \$ 428.55 \$ 483.84	\$ 247.30 \$ 273.22 \$ 299.14 \$ 350.99 \$ 376.91 \$ 402.83 \$ 454.81
14"	CPSPL-14048 CPSPL-14060 CPSPL-14072 CPSPL-14096 CPSPL-14108 CPSPL-14120 CPSPL-14144	CPSPL-14048-4K CPSPL-14060-4K CPSPL-14072-4K CPSPL-14096-4K CPSPL-14108-4K CPSPL-14120-4K CPSPL-14144-4K	Column - PVC, Square, Plain, 14" @ 4' Column - PVC, Square, Plain, 14" @ 5' Column - PVC, Square, Plain, 14" @ 6' Column - PVC, Square, Plain, 14" @ 8' Column - PVC, Square, Plain, 14" @ 9' Column - PVC, Square, Plain, 14" @ 10' Column - PVC, Square, Plain, 14" @ 12'	\$ 292.36 \$ 324.54 \$ 356.70 \$ 421.05 \$ 453.22 \$ 485.40 \$ 549.91	\$ 274.82 \$ 305.06 \$ 335.30 \$ 395.79 \$ 426.03 \$ 456.27 \$ 516.91

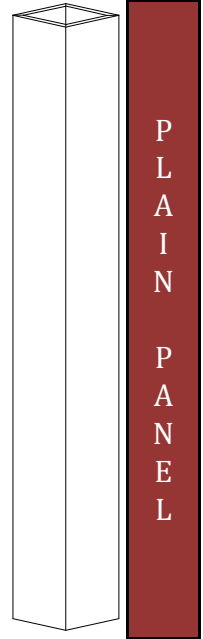

SIZE	DIMS	
	OUTSIDE	INSIDE
6"	5-1/2"	4-1/2"
8"	7-1/4"	6-1/4"
10"	9-3/8"	8-3/8"
12"	11-1/2"	10-1/2"
14"	13-1/4"	12-1/4"

\*12% FOR CUSTOM HEIGHT & 12% FOR ACTUAL WIDTH  
 \*\*\*FOR COLUMNS LARGER THAN 14" PLEASE CONTACT YOUR LOCAL PRESTIGE DEALER  
 \*\*PRICES SUBJECT TO CHANGE WITHOUT NOTICE

SQUARING "L" INCLUDED

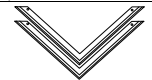

\*Adds 3" to Outside Dim's



PRICE LEVEL	
NON-STOCKING	
Standard C&B: 4" Craftsman	
CAP	4" Craftsman Skirt
BASE	4" Craftsman Skirt
<input checked="" type="checkbox"/> ADD CAP & BASE	

**PRESTIGE COLUMNS - 2017**

6" COLUMNS	PRODUCT CODE / SHAFT ONLY	PRODUCT CODE /w 4" SKIRTS	DESCRIPTION	PRICE	
				1 PIECE	6 PIECE
	CPSRA-06048	CPSRA-06048-4K	Column - PVC, Square, Raised Panel, 6" @ 4'	\$ 232.94	\$ 218.97
	CPSRA-06060	CPSRA-06060-4K	Column - PVC, Square, Raised Panel, 6" @ 5'	\$ 246.73	\$ 231.93
	CPSRA-06072	CPSRA-06072-4K	Column - PVC, Square, Raised Panel, 6" @ 6'	\$ 260.53	\$ 244.89
	CPSRA-06096	CPSRA-06096-4K	Column - PVC, Square, Raised Panel, 6" @ 8'	\$ 288.10	\$ 270.81
	CPSRA-06108	CPSRA-06108-4K	Column - PVC, Square, Raised Panel, 6" @ 9'	\$ 301.89	\$ 283.78
	CPSRA-06120	CPSRA-06120-4K	Column - PVC, Square, Raised Panel, 6" @ 10'	\$ 315.68	\$ 296.74
	CPSRA-06144	CPSRA-06144-4K	Column - PVC, Square, Raised Panel, 6" @ 12'	\$ 343.33	\$ 322.73
<b>8" COLUMNS</b>					
	CPSRA-08048	CPSRA-08048-4K	Column - PVC, Square, Raised Panel, 8" @ 4'	\$ 256.95	\$ 241.53
	CPSRA-08060	CPSRA-08060-4K	Column - PVC, Square, Raised Panel, 8" @ 5'	\$ 275.33	\$ 258.81
	CPSRA-08072	CPSRA-08072-4K	Column - PVC, Square, Raised Panel, 8" @ 6'	\$ 293.72	\$ 276.09
	CPSRA-08096	CPSRA-08096-4K	Column - PVC, Square, Raised Panel, 8" @ 8'	\$ 330.49	\$ 310.66
	CPSRA-08108	CPSRA-08108-4K	Column - PVC, Square, Raised Panel, 8" @ 9'	\$ 348.87	\$ 327.94
	CPSRA-08120	CPSRA-08120-4K	Column - PVC, Square, Raised Panel, 8" @ 10'	\$ 367.26	\$ 345.22
	CPSRA-08144	CPSRA-08144-4K	Column - PVC, Square, Raised Panel, 8" @ 12'	\$ 404.12	\$ 379.87
<b>10" COLUMNS</b>					
	CPSRA-10048	CPSRA-10048-4K	Column - PVC, Square, Raised Panel, 10" @ 4'	\$ 279.66	\$ 262.88
	CPSRA-10060	CPSRA-10060-4K	Column - PVC, Square, Raised Panel, 10" @ 5'	\$ 302.64	\$ 284.48
	CPSRA-10072	CPSRA-10072-4K	Column - PVC, Square, Raised Panel, 10" @ 6'	\$ 325.63	\$ 306.09
	CPSRA-10096	CPSRA-10096-4K	Column - PVC, Square, Raised Panel, 10" @ 8'	\$ 371.59	\$ 349.29
	CPSRA-10108	CPSRA-10108-4K	Column - PVC, Square, Raised Panel, 10" @ 9'	\$ 394.56	\$ 370.89
	CPSRA-10120	CPSRA-10120-4K	Column - PVC, Square, Raised Panel, 10" @ 10'	\$ 417.54	\$ 392.49
	CPSRA-10144	CPSRA-10144-4K	Column - PVC, Square, Raised Panel, 10" @ 12'	\$ 463.63	\$ 435.81
<b>12" COLUMNS</b>					
	CPSRA-12048	CPSRA-12048-4K	Column - PVC, Square, Raised Panel, 12" @ 4'	\$ 302.36	\$ 284.22
	CPSRA-12120	CPSRA-12060-4K	Column - PVC, Square, Raised Panel, 12" @ 5'	\$ 329.95	\$ 310.15
	CPSRA-12072	CPSRA-12072-4K	Column - PVC, Square, Raised Panel, 12" @ 6'	\$ 357.52	\$ 336.07
	CPSRA-12096	CPSRA-12096-4K	Column - PVC, Square, Raised Panel, 12" @ 8'	\$ 412.67	\$ 387.91
	CPSRA-12108	CPSRA-12108-4K	Column - PVC, Square, Raised Panel, 12" @ 9'	\$ 440.25	\$ 413.83
	CPSRA-12120	CPSRA-12120-4K	Column - PVC, Square, Raised Panel, 12" @ 10'	\$ 467.83	\$ 439.76
	CPSRA-12144	CPSRA-12144-4K	Column - PVC, Square, Raised Panel, 12" @ 12'	\$ 523.12	\$ 491.73
<b>14" COLUMNS</b>					
	CPSRA-14048	CPSRA-14048-4K	Column - PVC, Square, Raised Panel, 14" @ 4'	\$ 336.92	\$ 316.70
	CPSRA-14060	CPSRA-14060-4K	Column - PVC, Square, Raised Panel, 14" @ 5'	\$ 369.09	\$ 346.95
	CPSRA-14072	CPSRA-14072-4K	Column - PVC, Square, Raised Panel, 14" @ 6'	\$ 401.26	\$ 377.18
	CPSRA-14096	CPSRA-14096-4K	Column - PVC, Square, Raised Panel, 14" @ 8'	\$ 465.61	\$ 437.67
	CPSRA-14108	CPSRA-14108-4K	Column - PVC, Square, Raised Panel, 14" @ 9'	\$ 497.78	\$ 467.91
	CPSRA-14120	CPSRA-14120-4K	Column - PVC, Square, Raised Panel, 14" @ 10'	\$ 529.95	\$ 498.16
	CPSRA-14144	CPSRA-14144-4K	Column - PVC, Square, Raised Panel, 14" @ 12'	\$ 594.46	\$ 558.80

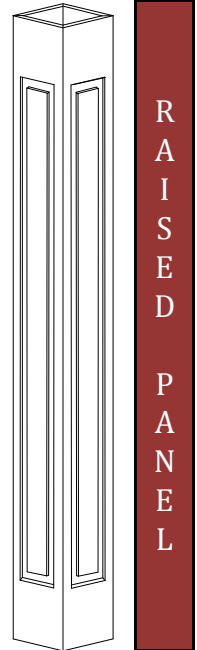

DIMS		
SIZE	OUTSIDE	INSIDE
6"	5-1/2"	4-1/2"
8"	7-1/4"	6-1/4"
10"	9-3/8"	8-3/8"
12"	11-1/2"	10-1/2"
14"	13-1/4"	12-1/4"

\*12% FOR CUSTOM HEIGHT & 12% FOR ACTUAL WIDTH & 12% FOR DOUBLE PANEL  
 \*\*\*FOR COLUMNS LARGER THAN 14" PLEASE CONTACT YOUR LOCAL PRESTIGE DEALER  
 \*\*PRICES SUBJECT TO CHANGE WITHOUT NOTICE

**SQUARING "L" INCLUDED**



\*Adds 3" to Outside Dims



PRICE LEVEL	
NON-STOCKING	
Standard C&B: 4" Craftsman	
CAP	4" Craftsman Skirt
BASE	4" Craftsman Skirt
<input checked="" type="checkbox"/> ADD CAP & BASE	

**PRESTIGE COLUMNS - 2017**

COLUMNS	PRODUCT CODE / SHAFT ONLY	PRODUCT CODE /w 4" SKIRTS	DESCRIPTION	1 PIECE	6 PIECE
	6" COLUMNS	CPSFL-06048	CPSFL-06048-4K	Column - PVC, Square, Fluted Panel, 6" @ 4'	\$ 232.94
CPSFL-06060		CPSFL-06060-4K	Column - PVC, Square, Fluted Panel, 6" @ 5'	\$ 246.73	\$ 231.93
CPSFL-06072		CPSFL-06072-4K	Column - PVC, Square, Fluted Panel, 6" @ 6'	\$ 260.53	\$ 244.89
CPSFL-06096		CPSFL-06096-4K	Column - PVC, Square, Fluted Panel, 6" @ 8'	\$ 288.10	\$ 270.81
CPSFL-06108		CPSFL-06108-4K	Column - PVC, Square, Fluted Panel, 6" @ 9'	\$ 301.89	\$ 283.78
CPSFL-06120		CPSFL-06120-4K	Column - PVC, Square, Fluted Panel, 6" @ 10'	\$ 315.68	\$ 296.74
CPSFL-06144		CPSFL-06144-4K	Column - PVC, Square, Fluted Panel, 6" @ 12'	\$ 343.33	\$ 322.73
8" COLUMNS	CPSFL-08048	CPSFL-08048-4K	Column - PVC, Square, Fluted Panel, 8" @ 4'	\$ 256.95	\$ 241.53
	CPSFL-08060	CPSFL-08060-4K	Column - PVC, Square, Fluted Panel, 8" @ 5'	\$ 275.33	\$ 258.81
	CPSFL-08072	CPSFL-08072-4K	Column - PVC, Square, Fluted Panel, 8" @ 6'	\$ 293.72	\$ 276.09
	CPSFL-08096	CPSFL-08096-4K	Column - PVC, Square, Fluted Panel, 8" @ 8'	\$ 330.49	\$ 310.66
	CPSFL-08108	CPSFL-08108-4K	Column - PVC, Square, Fluted Panel, 8" @ 9'	\$ 348.87	\$ 327.94
	CPSFL-08120	CPSFL-08120-4K	Column - PVC, Square, Fluted Panel, 8" @ 10'	\$ 367.26	\$ 345.22
	CPSFL-08144	CPSFL-08144-4K	Column - PVC, Square, Fluted Panel, 8" @ 12'	\$ 404.12	\$ 379.87
10" COLUMNS	CPSFL-10048	CPSFL-10048-4K	Column - PVC, Square, Fluted Panel, 10" @ 4'	\$ 279.66	\$ 262.88
	CPSFL-10060	CPSFL-10060-4K	Column - PVC, Square, Fluted Panel, 10" @ 5'	\$ 302.64	\$ 284.48
	CPSFL-10072	CPSFL-10072-4K	Column - PVC, Square, Fluted Panel, 10" @ 6'	\$ 325.63	\$ 306.09
	CPSFL-10096	CPSFL-10096-4K	Column - PVC, Square, Fluted Panel, 10" @ 8'	\$ 371.59	\$ 349.29
	CPSFL-10108	CPSFL-10108-4K	Column - PVC, Square, Fluted Panel, 10" @ 9'	\$ 394.56	\$ 370.89
	CPSFL-10120	CPSFL-10120-4K	Column - PVC, Square, Fluted Panel, 10" @ 10'	\$ 417.54	\$ 392.49
	CPSFL-10144	CPSFL-10144-4K	Column - PVC, Square, Fluted Panel, 10" @ 12'	\$ 463.63	\$ 435.81
12" COLUMNS	CPSFL-12048	CPSFL-12048-4K	Column - PVC, Square, Fluted Panel, 12" @ 4'	\$ 302.36	\$ 284.22
	CPSFL-12060	CPSFL-12060-4K	Column - PVC, Square, Fluted Panel, 12" @ 5'	\$ 329.95	\$ 310.15
	CPSFL-12072	CPSFL-12072-4K	Column - PVC, Square, Fluted Panel, 12" @ 6'	\$ 357.52	\$ 336.07
	CPSFL-12096	CPSFL-12096-4K	Column - PVC, Square, Fluted Panel, 12" @ 8'	\$ 412.67	\$ 387.91
	CPSFL-12108	CPSFL-12108-4K	Column - PVC, Square, Fluted Panel, 12" @ 9'	\$ 440.25	\$ 413.83
	CPSFL-12120	CPSFL-12120-4K	Column - PVC, Square, Fluted Panel, 12" @ 10'	\$ 467.83	\$ 439.76
	CPSFL-12144	CPSFL-12144-4K	Column - PVC, Square, Fluted Panel, 12" @ 12'	\$ 523.12	\$ 491.73
14" COLUMNS	CPSFL-14048	CPSFL-14048-4K	Column - PVC, Square, Fluted Panel, 14" @ 4'	\$ 336.92	\$ 316.70
	CPSFL-14060	CPSFL-14060-4K	Column - PVC, Square, Fluted Panel, 14" @ 5'	\$ 369.09	\$ 346.95
	CPSFL-14072	CPSFL-14072-4K	Column - PVC, Square, Fluted Panel, 14" @ 6'	\$ 401.26	\$ 377.18
	CPSFL-14096	CPSFL-14096-4K	Column - PVC, Square, Fluted Panel, 14" @ 8'	\$ 465.61	\$ 437.67
	CPSFL-14108	CPSFL-14108-4K	Column - PVC, Square, Fluted Panel, 14" @ 9'	\$ 497.78	\$ 467.91
	CPSFL-14120	CPSFL-14120-4K	Column - PVC, Square, Fluted Panel, 14" @ 10'	\$ 529.95	\$ 498.16
	CPSFL-14144	CPSFL-14144-4K	Column - PVC, Square, Fluted Panel, 14" @ 12'	\$ 594.46	\$ 558.80

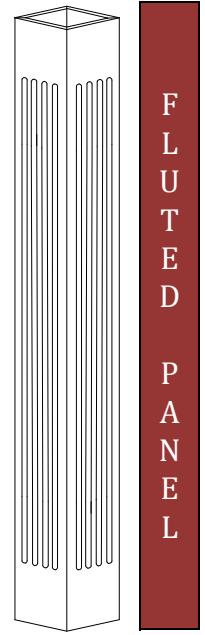

DIMS		
SIZE	OUTSIDE	INSIDE
6"	5-1/2"	4-1/2"
8"	7-1/4"	6-1/4"
10"	9-3/8"	8-3/8"
12"	11-1/2"	10-1/2"
14"	13-1/4"	12-1/4"

\*12% FOR CUSTOM HEIGHT & 12% FOR ACTUAL WIDTH  
 \*\*\*FOR COLUMNS LARGER THAN 14" PLEASE CONTACT YOUR LOCAL PRESTIGE DEALER  
 \*\*PRICES SUBJECT TO CHANGE WITHOUT NOTICE



\*Adds 3" to Outside Dims



PRICE LEVEL	
NON-STOCKING	
Standard C&B: 4" Craftsman	
CAP	4" Craftsman Skirt
BASE	4" Craftsman Skirt
<input checked="" type="checkbox"/> ADD CAP & BASE	

**PRESTIGE COLUMNS - 2017**

8" COLUMNS	PRODUCT CODE / SHAFT ONLY	PRODUCT CODE /w 4" SKIRTS	DESCRIPTION	1 PIECE	6 PIECE
		CPSRS-08048	CPSRS-08048-4K	Column - PVC, Square, Recessed Square Edge Panel, 8" @ 4'	\$ 267.46
	CPSRS-08060	CPSRS-08060-4K	Column - PVC, Square, Recessed Square Edge Panel, 8" @ 5'	\$ 295.11	\$ 277.40
	CPSRS-08072	CPSRS-08072-4K	Column - PVC, Square, Recessed Square Edge Panel, 8" @ 6'	\$ 322.75	\$ 303.38
	CPSRS-08096	CPSRS-08096-4K	Column - PVC, Square, Recessed Square Edge Panel, 8" @ 8'	\$ 378.03	\$ 355.35
	CPSRS-08108	CPSRS-08108-4K	Column - PVC, Square, Recessed Square Edge Panel, 8" @ 9'	\$ 405.67	\$ 381.33
	CPSRS-08120	CPSRS-08120-4K	Column - PVC, Square, Recessed Square Edge Panel, 8" @ 10'	\$ 433.31	\$ 407.31
	CPSRS-08144	CPSRS-08144-4K	Column - PVC, Square, Recessed Square Edge Panel, 8" @ 12'	\$ 488.59	\$ 459.27
10" COLUMNS	CPSRS-10048	CPSRS-10048-4K	Column - PVC, Square, Recessed Square Edge Panel, 10" @ 4'	\$ 299.37	\$ 281.40
	CPSRS-10060	CPSRS-10060-4K	Column - PVC, Square, Recessed Square Edge Panel, 10" @ 5'	\$ 335.53	\$ 315.40
	CPSRS-10072	CPSRS-10072-4K	Column - PVC, Square, Recessed Square Edge Panel, 10" @ 6'	\$ 371.71	\$ 349.41
	CPSRS-10096	CPSRS-10096-4K	Column - PVC, Square, Recessed Square Edge Panel, 10" @ 8'	\$ 444.05	\$ 417.41
	CPSRS-10108	CPSRS-10108-4K	Column - PVC, Square, Recessed Square Edge Panel, 10" @ 9'	\$ 480.22	\$ 451.40
	CPSRS-10120	CPSRS-10120-4K	Column - PVC, Square, Recessed Square Edge Panel, 10" @ 10'	\$ 516.38	\$ 485.40
	CPSRS-10144	CPSRS-10144-4K	Column - PVC, Square, Recessed Square Edge Panel, 10" @ 12'	\$ 588.73	\$ 553.41
12" COLUMNS	CPSRS-12048	CPSRS-12048-4K	Column - PVC, Square, Recessed Square Edge Panel, 12" @ 4'	\$ 328.00	\$ 308.32
	CPSRS-12060	CPSRS-12060-4K	Column - PVC, Square, Recessed Square Edge Panel, 12" @ 5'	\$ 371.31	\$ 349.03
	CPSRS-12072	CPSRS-12072-4K	Column - PVC, Square, Recessed Square Edge Panel, 12" @ 6'	\$ 414.63	\$ 389.75
	CPSRS-12096	CPSRS-12096-4K	Column - PVC, Square, Recessed Square Edge Panel, 12" @ 8'	\$ 501.25	\$ 471.18
	CPSRS-12108	CPSRS-12108-4K	Column - PVC, Square, Recessed Square Edge Panel, 12" @ 9'	\$ 564.13	\$ 530.28
	CPSRS-12120	CPSRS-12120-4K	Column - PVC, Square, Recessed Square Edge Panel, 12" @ 10'	\$ 587.88	\$ 552.60
	CPSRS-12144	CPSRS-12144-4K	Column - PVC, Square, Recessed Square Edge Panel, 12" @ 12'	\$ 674.50	\$ 634.03
14" COLUMNS	CPSRS-14048	CPSRS-14048-4K	Column - PVC, Square, Recessed Square Edge Panel, 14" @ 4'	\$ 366.67	\$ 344.67
	CPSRS-14060	CPSRS-14060-4K	Column - PVC, Square, Recessed Square Edge Panel, 14" @ 5'	\$ 418.28	\$ 393.18
	CPSRS-14072	CPSRS-14072-4K	Column - PVC, Square, Recessed Square Edge Panel, 14" @ 6'	\$ 469.90	\$ 441.70
	CPSRS-14096	CPSRS-14096-4K	Column - PVC, Square, Recessed Square Edge Panel, 14" @ 8'	\$ 573.11	\$ 538.73
	CPSRS-14108	CPSRS-14108-4K	Column - PVC, Square, Recessed Square Edge Panel, 14" @ 9'	\$ 624.73	\$ 587.25
	CPSRS-14120	CPSRS-14120-4K	Column - PVC, Square, Recessed Square Edge Panel, 14" @ 10'	\$ 676.34	\$ 635.76
	CPSRS-14144	CPSRS-14144-4K	Column - PVC, Square, Recessed Square Edge Panel, 14" @ 12'	\$ 779.56	\$ 732.79

\*12% FOR CUSTOM HEIGHT & 12% FOR ACTUAL WIDTH  
 \*\*\*FOR COLUMNS LARGER THAN 14" PLEASE CONTACT YOUR LOCAL PRESTIGE DEALER  
 \*\*PRICES SUBJECT TO CHANGE WITHOUT NOTICE

**NOTE:**

6" - 10" columns with square edge recessed panels will use either a 3/8" or a 1/2" thick backer panel.  
 12" columns and larger, with square edge recessed panels, will use a 1/2" thick backer panel.  
 All columns with recessed panel with base cap trim will use a 3/8" thick backer panel.

Recessed panel with base cap trim will only wrap a 5" wide structure.

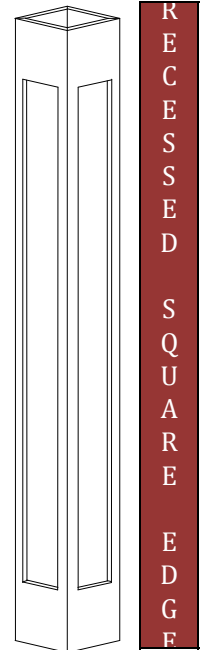

SIZE	DIMS	
	OUTSIDE	INSIDE
8"	7-1/4"	5-1/4"
10"	9-3/8"	7-3/8"
12"	11-1/2"	9-1/2"
14"	13-1/4"	11-1/4"

SQUARING "L" INCLUDED



\*Adds 3" to Outside Dims





PRICE LEVEL	
NON-STOCKING	
Standard C&B: 4" Craftsman	
CAP	4" Craftsman Skirt
BASE	4" Craftsman Skirt
<input checked="" type="checkbox"/> ADD CAP & BASE	

**PRESTIGE COLUMNS - 2017**

	PRODUCT CODE / SHAFT ONLY	PRODUCT CODE /w 4" SKIRTS	DESCRIPTION	1 PIECE	6 PIECE	
<b>8" COLUMNS</b>	CPSRBF-08048	CPSRBF-08048-4K	Column - PVC, Square, Recessed Flush Trim Panel, 8" @ 4'	\$ 355.25	\$ 333.93	
	CPSRBF-08060	CPSRBF-08060-4K	Column - PVC, Square, Recessed Flush Trim Panel, 8" @ 5'	\$ 394.72	\$ 371.04	
	CPSRBF-08072	CPSRBF-08072-4K	Column - PVC, Square, Recessed Flush Trim Panel, 8" @ 6'	\$ 434.18	\$ 408.13	
	CPSRBF-08096	CPSRBF-08096-4K	Column - PVC, Square, Recessed Flush Trim Panel, 8" @ 8'	\$ 513.12	\$ 482.33	
	CPSRBF-08108	CPSRBF-08108-4K	Column - PVC, Square, Recessed Flush Trim Panel, 8" @ 9'	\$ 552.59	\$ 519.44	
	CPSRBF-08120	CPSRBF-08120-4K	Column - PVC, Square, Recessed Flush Trim Panel, 8" @ 10'	\$ 592.06	\$ 556.53	
	CPSRBF-08144	CPSRBF-08144-4K	Column - PVC, Square, Recessed Flush Trim Panel, 8" @ 12'	\$ 670.99	\$ 630.73	
	<b>10" COLUMNS</b>	CPSRBF-10048	CPSRBF-10048-4K	Column - PVC, Square, Recessed Flush Trim Panel, 10" @ 4'	\$ 386.83	\$ 363.62
		CPSRBF-10060	CPSRBF-10060-4K	Column - PVC, Square, Recessed Flush Trim Panel, 10" @ 5'	\$ 432.51	\$ 406.56
		CPSRBF-10072	CPSRBF-10072-4K	Column - PVC, Square, Recessed Flush Trim Panel, 10" @ 6'	\$ 478.18	\$ 449.49
CPSRBF-10096		CPSRBF-10096-4K	Column - PVC, Square, Recessed Flush Trim Panel, 10" @ 8'	\$ 569.52	\$ 535.35	
CPSRBF-10108		CPSRBF-10108-4K	Column - PVC, Square, Recessed Flush Trim Panel, 10" @ 9'	\$ 615.20	\$ 578.29	
CPSRBF-10120		CPSRBF-10120-4K	Column - PVC, Square, Recessed Flush Trim Panel, 10" @ 10'	\$ 660.88	\$ 621.22	
CPSRBF-10144		CPSRBF-10144-4K	Column - PVC, Square, Recessed Flush Trim Panel, 10" @ 12'	\$ 752.22	\$ 707.09	
<b>12" COLUMNS</b>		CPSRBF-12048	CPSRBF-12048-4K	Column - PVC, Square, Recessed Flush Trim Panel, 12" @ 4'	\$ 417.54	\$ 392.49
		CPSRBF-12060	CPSRBF-12060-4K	Column - PVC, Square, Recessed Flush Trim Panel, 12" @ 5'	\$ 469.42	\$ 441.26
		CPSRBF-12072	CPSRBF-12072-4K	Column - PVC, Square, Recessed Flush Trim Panel, 12" @ 6'	\$ 521.29	\$ 490.02
	CPSRBF-12096	CPSRBF-12096-4K	Column - PVC, Square, Recessed Flush Trim Panel, 12" @ 8'	\$ 625.05	\$ 587.54	
	CPSRBF-12108	CPSRBF-12108-4K	Column - PVC, Square, Recessed Flush Trim Panel, 12" @ 9'	\$ 676.93	\$ 636.31	
	CPSRBF-12120	CPSRBF-12120-4K	Column - PVC, Square, Recessed Flush Trim Panel, 12" @ 10'	\$ 728.80	\$ 685.07	
	CPSRBF-12144	CPSRBF-12144-4K	Column - PVC, Square, Recessed Flush Trim Panel, 12" @ 12'	\$ 832.55	\$ 782.60	
	<b>14" COLUMNS</b>	CPSRBF-14048	CPSRBF-14048-4K	Column - PVC, Square, Recessed Flush Trim Panel, 14" @ 4'	\$ 460.83	\$ 433.18
		CPSRBF-14060	CPSRBF-14060-4K	Column - PVC, Square, Recessed Flush Trim Panel, 14" @ 5'	\$ 518.91	\$ 487.77
		CPSRBF-14072	CPSRBF-14072-4K	Column - PVC, Square, Recessed Flush Trim Panel, 14" @ 6'	\$ 576.99	\$ 542.37
CPSRBF-14096		CPSRBF-14096-4K	Column - PVC, Square, Recessed Flush Trim Panel, 14" @ 8'	\$ 693.15	\$ 651.56	
CPSRBF-14108		CPSRBF-14108-4K	Column - PVC, Square, Recessed Flush Trim Panel, 14" @ 9'	\$ 751.23	\$ 706.15	
CPSRBF-14120		CPSRBF-14120-4K	Column - PVC, Square, Recessed Flush Trim Panel, 14" @ 10'	\$ 809.31	\$ 760.75	
CPSRBF-14144		CPSRBF-14144-4K	Column - PVC, Square, Recessed Flush Trim Panel, 14" @ 12'	\$ 925.47	\$ 869.94	

**\*12% FOR CUSTOM HEIGHT & 12% FOR ACTUAL WIDTH**  
**\*\*\*FOR COLUMNS LARGER THAN 14" PLEASE CONTACT YOUR LOCAL PRESTIGE DEALER**  
**\*\*PRICES SUBJECT TO CHANGE WITHOUT NOTICE**

**NOTE:**  
 6" - 10" columns with square edge recessed panels will use either a 3/8" or a 1/2" thick backer panel.  
 12" columns and larger, with square edge recessed panels, will use a 1/2" thick backer panel.  
 All columns with recessed panel with base cap trim will use a 3/8" thick backer panel.

Recessed panel with base cap trim will only wrap a 5" wide structure.

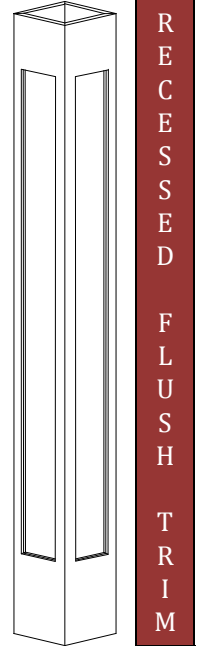

DIMS		
SIZE	OUTSIDE	INSIDE
8"	7-1/4"	5-1/4"
10"	9-3/8"	7-3/8"
12"	11-1/2"	9-1/2"
14"	13-1/4"	11-1/4"

**SQUARING "L" INCLUDED**



**\*Adds 3" to Outside Dims**



PRICE LEVEL
NON-STOCKING
Standard C&B: 4" Craftsman
CAP 4" Craftsman Skirt
BASE 4" Craftsman Skirt
<input checked="" type="checkbox"/> ADD CAP & BASE

**PRESTIGE COLUMNS - 2017**

8" COLUMNS	PRODUCT CODE / SHAFT ONLY	PRODUCT CODE /w 4" SKIRTS	DESCRIPTION	1 PIECE	6 PIECE
		CPSRBF-08048	CPSRBR-08048-4K	Column - PVC, Square, Recessed Raised Trim Panel, 8" @ 4'	\$ 355.86
	CPSRBF-08060	CPSRBR-08060-4K	Column - PVC, Square, Recessed Raised Trim Panel, 8" @ 5'	\$ 395.41	\$ 371.68
	CPSRBF-08072	CPSRBR-08072-4K	Column - PVC, Square, Recessed Raised Trim Panel, 8" @ 6'	\$ 434.96	\$ 408.86
	CPSRBF-08096	CPSRBR-08096-4K	Column - PVC, Square, Recessed Raised Trim Panel, 8" @ 8'	\$ 514.04	\$ 483.20
	CPSRBF-08108	CPSRBR-08108-4K	Column - PVC, Square, Recessed Raised Trim Panel, 8" @ 9'	\$ 553.58	\$ 520.36
	CPSRBF-08120	CPSRBR-08120-4K	Column - PVC, Square, Recessed Raised Trim Panel, 8" @ 10'	\$ 593.12	\$ 557.54
	CPSRBF-08144	CPSRBR-08144-4K	Column - PVC, Square, Recessed Raised Trim Panel, 8" @ 12'	\$ 672.21	\$ 631.87

10" COLUMNS	PRODUCT CODE / SHAFT ONLY	PRODUCT CODE /w 4" SKIRTS	DESCRIPTION	1 PIECE	6 PIECE
		CPSRBF-10048	CPSRBR-10048-4K	Column - PVC, Square, Recessed Raised Trim Panel, 10" @ 4'	\$ 387.51
	CPSRBF-10060	CPSRBR-10060-4K	Column - PVC, Square, Recessed Raised Trim Panel, 10" @ 5'	\$ 433.27	\$ 407.27
	CPSRBF-10072	CPSRBR-10072-4K	Column - PVC, Square, Recessed Raised Trim Panel, 10" @ 6'	\$ 479.02	\$ 450.28
	CPSRBF-10096	CPSRBR-10096-4K	Column - PVC, Square, Recessed Raised Trim Panel, 10" @ 8'	\$ 570.54	\$ 536.30
	CPSRBF-10108	CPSRBR-10108-4K	Column - PVC, Square, Recessed Raised Trim Panel, 10" @ 9'	\$ 616.30	\$ 579.32
	CPSRBF-10120	CPSRBR-10120-4K	Column - PVC, Square, Recessed Raised Trim Panel, 10" @ 10'	\$ 662.06	\$ 622.34
	CPSRBF-10144	CPSRBR-10144-4K	Column - PVC, Square, Recessed Raised Trim Panel, 10" @ 12'	\$ 753.57	\$ 708.36

12" COLUMNS	PRODUCT CODE / SHAFT ONLY	PRODUCT CODE /w 4" SKIRTS	DESCRIPTION	1 PIECE	6 PIECE
		CPSRBF-12048	CPSRBR-12048-4K	Column - PVC, Square, Recessed Raised Trim Panel, 12" @ 4'	\$ 418.26
	CPSRBF-12060	CPSRBR-12060-4K	Column - PVC, Square, Recessed Raised Trim Panel, 12" @ 5'	\$ 470.24	\$ 442.02
	CPSRBF-12072	CPSRBR-12072-4K	Column - PVC, Square, Recessed Raised Trim Panel, 12" @ 6'	\$ 522.21	\$ 490.88
	CPSRBF-12096	CPSRBR-12096-4K	Column - PVC, Square, Recessed Raised Trim Panel, 12" @ 8'	\$ 626.17	\$ 588.60
	CPSRBF-12108	CPSRBR-12108-4K	Column - PVC, Square, Recessed Raised Trim Panel, 12" @ 9'	\$ 678.13	\$ 637.44
	CPSRBF-12120	CPSRBR-12120-4K	Column - PVC, Square, Recessed Raised Trim Panel, 12" @ 10'	\$ 730.11	\$ 686.30
	CPSRBF-12144	CPSRBR-12144-4K	Column - PVC, Square, Recessed Raised Trim Panel, 12" @ 12'	\$ 834.06	\$ 784.02

14" COLUMNS	PRODUCT CODE / SHAFT ONLY	PRODUCT CODE /w 4" SKIRTS	DESCRIPTION	1 PIECE	6 PIECE
		CPSRBF-14048	CPSRBR-14048-4K	Column - PVC, Square, Recessed Raised Trim Panel, 14" @ 4'	\$ 461.62
	CPSRBF-14060	CPSRBR-14060-4K	Column - PVC, Square, Recessed Raised Trim Panel, 14" @ 5'	\$ 519.81	\$ 488.62
	CPSRBF-14072	CPSRBR-14072-4K	Column - PVC, Square, Recessed Raised Trim Panel, 14" @ 6'	\$ 578.00	\$ 543.32
	CPSRBF-14096	CPSRBR-14096-4K	Column - PVC, Square, Recessed Raised Trim Panel, 14" @ 8'	\$ 694.38	\$ 652.72
	CPSRBF-14108	CPSRBR-14108-4K	Column - PVC, Square, Recessed Raised Trim Panel, 14" @ 9'	\$ 752.57	\$ 707.41
	CPSRBF-14120	CPSRBR-14120-4K	Column - PVC, Square, Recessed Raised Trim Panel, 14" @ 10'	\$ 810.75	\$ 762.11
	CPSRBF-14144	CPSRBR-14144-4K	Column - PVC, Square, Recessed Raised Trim Panel, 14" @ 12'	\$ 927.14	\$ 871.51

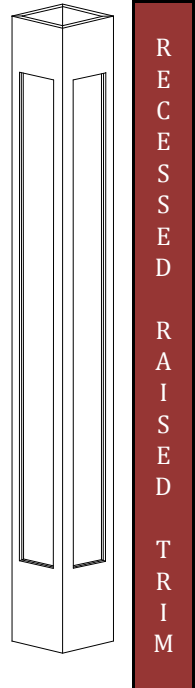

\*12% FOR CUSTOM HEIGHT & 12% FOR ACTUAL WIDTH  
 \*\*\*FOR COLUMNS LARGER THAN 14" PLEASE CONTACT YOUR LOCAL PRESTIGE DEALER  
 \*\*PRICES SUBJECT TO CHANGE WITHOUT NOTICE

**NOTE:**  
 6" – 10" columns with square edge recessed panels will use either a 3/8" or a 1/2" thick backer panel.  
 12" columns and larger, with square edge recessed panels, will use a 1/2" thick backer panel.  
 All columns with recessed panel with base cap trim will use a 3/8" thick backer panel.

Recessed panel with base cap trim will only wrap a 5" wide structure.

DIMS		
SIZE	OUTSIDE	INSIDE
8"	7-1/4"	5-1/4"
10"	9-3/8"	7-3/8"
12"	11-1/2"	9-1/2"
14"	13-1/4"	11-1/4"

**SQUARING "L" INCLUDED**



\*Adds 3" to Outside Dims

**PRESTIGE COLUMNS - 2017**

C  
A  
P  
&  
B  
A  
S  
E  
O  
P  
T  
I  
O  
N  
S

6" COLUMNS

PRODUCT CODE
CSP314
CSP316
CSP318
CSP116
CSP118
CSP414
CSP415
CSP416
CSP616
CSP618
CSP61A
CSP716
CSP718
CSP71A
CSP512
ASTRG-0606

DESCRIPTION
Skirt-PVC,CMN-6"Col-4"
Skirt-PVC,CMN-6"Col-6"
Skirt-PVC,CMN-6"Col-8"
Skirt-PVC,BSE CP-6"Col-6"
Skirt-PVC,BSE CP-6"Col-8"
Skirt-PVC,CRWN-6"Col-4"
Skirt-PVC,CRWN-6"Col-5"
Skirt-PVC,CRWN-6"Col-6"
Skirt-PVC,TSCN-6"Col-6"
Skirt-PVC,TSCN-6"Col-8"
Skirt-PVC,TSCN-6"Col-10"
Skirt-PVC,CHMFRD-6"Col-6"
Skirt-PVC,CHMFRD-6"Col-8"
Skirt-PVC,CHMFRD-6"Col-10"
Skirt-PVC,SLD CRWN-6"Col-2"
Astragal-PVC, BSE CP-6" Col

SINGLE SKIRT	SKIRT SET
\$ 11.53	\$ 23.06
\$ 13.10	\$ 26.20
\$ 14.47	\$ 28.93
\$ 28.03	\$ 56.05
\$ 30.84	\$ 61.67
\$ 36.77	\$ 73.54
\$ 49.56	\$ 99.13
\$ 57.10	\$ 114.20
\$ 49.40	\$ 98.81
\$ 54.51	\$ 109.02
\$ 59.62	\$ 119.24
\$ 40.01	\$ 80.02
\$ 45.11	\$ 90.22
\$ 50.22	\$ 100.45
\$ 29.40	\$ 58.81
\$ 35.60	

8" COLUMNS

CSP324
CSP326
CSP328
CSP126
CSP128
CSP424
CSP425
CSP426
CSP626
CSP628
CSP62A
CSP726
CSP728
CSP72A
CSP522
ASTRG-0808

Skirt-PVC,CMN-8"Col-4"
Skirt-PVC,CMN-8"Col-6"
Skirt-PVC,CMN-8"Col-8"
Skirt-PVC,BSE CP-8"Col-6"
Skirt-PVC,BSE CP-8"Col-8"
Skirt-PVC,CRWN-8"Col-4"
Skirt-PVC,CRWN-8"Col-5"
Skirt-PVC,CRWN-8"Col-6"
Skirt-PVC,TSCN-8"Col-6"
Skirt-PVC,TSCN-8"Col-8"
Skirt-PVC,TSCN-8"Col-10"
Skirt-PVC,CHMFRD-8"Col-6"
Skirt-PVC,CHMFRD-8"Col-8"
Skirt-PVC,CHMFRD-8"Col-10"
Skirt-PVC,SLD CRWN-8"Col-2"
Astragal-PVC, BSE CP-8" Col

\$ 13.71	\$ 27.41
\$ 14.58	\$ 29.17
\$ 16.33	\$ 32.65
\$ 37.37	\$ 74.74
\$ 41.11	\$ 82.22
\$ 42.22	\$ 84.44
\$ 53.98	\$ 107.95
\$ 61.81	\$ 123.62
\$ 53.63	\$ 107.26
\$ 60.16	\$ 120.31
\$ 66.68	\$ 133.36
\$ 44.24	\$ 88.47
\$ 50.76	\$ 101.52
\$ 57.28	\$ 114.57
\$ 32.65	\$ 65.30
\$ 40.77	

10" COLUMNS

CSP334
CSP336
CSP338
CSP136
CSP138
CSP434
CSP435
CSP436
CSP636
CSP638
CSP63A
CSP736
CSP738
CSP73A
CSP532
ASTRG-1010

Skirt-PVC,CMN-10"col-4"
Skirt-PVC,CMN-10"col-6"
Skirt-PVC,CMN-10"col-8"
Skirt-PVC,BSE CP-10"col-6"
Skirt-PVC,BSE CP-10"col-8"
Skirt-PVC,CRWN-10"col-4"
Skirt-PVC,CRWN-10"col-5"
Skirt-PVC,CRWN-10"col-6"
Skirt-PVC,TSCN-10"col-6"
Skirt-PVC,TSCN-10"col-8"
Skirt-PVC,TSCN-10"col-10"
Skirt-PVC,CHMFRD-10"col-6"
Skirt-PVC,CHMFRD-10"col-8"
Skirt-PVC,CHMFRD-10"col-10"
Skirt-PVC,SLD CRWN-10"col-2"
Astragal-PVC, BSE CP-10" Col

\$ 15.25	\$ 30.50
\$ 22.95	\$ 45.90
\$ 27.20	\$ 54.39
\$ 46.71	\$ 93.42
\$ 51.39	\$ 102.78
\$ 42.93	\$ 85.85
\$ 58.40	\$ 116.80
\$ 66.52	\$ 133.03
\$ 57.87	\$ 115.74
\$ 65.79	\$ 131.59
\$ 73.73	\$ 147.46
\$ 48.47	\$ 96.94
\$ 56.40	\$ 112.79
\$ 64.33	\$ 128.66
\$ 35.90	\$ 71.81
\$ 42.95	

CAP & BASE OPTIONS

12" COLUMNS

CSP344	Skirt-PVC,CMN-12"col-4"	\$ 16.78	\$ 33.56
CSP346	Skirt-PVC,CMN-12"col-6"	\$ 25.32	\$ 50.65
CSP348	Skirt-PVC,CMN-12"col-8"	\$ 30.33	\$ 60.66
CSP146	Skirt-PVC,BSE CP-12"col-6"	\$ 56.06	\$ 112.12
CSP148	Skirt-PVC,BSE CP-12"col-8"	\$ 61.67	\$ 123.33
CSP444	Skirt-PVC,CRWN-12"col-4"	\$ 45.98	\$ 91.96
CSP445	Skirt-PVC,CRWN-12"col-5"	\$ 62.82	\$ 125.63
CSP446	Skirt-PVC,CRWN-12"col-6"	\$ 71.23	\$ 142.45
CSP645	Skirt-PVC,TSCN-12"col-5"	\$ 57.43	\$ 114.85
CSP646	Skirt-PVC,TSCN-12"col-6"	\$ 62.09	\$ 124.19
CSP648	Skirt-PVC,TSCN-12"col-8"	\$ 71.44	\$ 142.88
CSP64A	Skirt-PVC,TSCN-12"col-10"	\$ 80.78	\$ 161.56
CSP746	Skirt-PVC,CHMFRD-12"col-6"	\$ 52.69	\$ 105.39
CSP748	Skirt-PVC,CHMFRD-12"col-8"	\$ 62.05	\$ 124.09
CSP74A	Skirt-PVC,CHMFRD-12"col-10"	\$ 71.38	\$ 142.76
CSP542	Skirt-PVC,SLD CRWN-12"col-2"	\$ 39.16	\$ 78.31
ASTRG-1212	Astragal-PVC, BSE CP-12" Col	\$ 45.13	

14" COLUMNS

CSP354	Skirt-PVC,CMN-14"col-4"	\$ 21.98	\$ 43.95
CSP356	Skirt-PVC,CMN-14"col-6"	\$ 33.24	\$ 66.48
CSP358	Skirt-PVC,CMN-14"col-8"	\$ 40.13	\$ 80.26
CSP156	Skirt-PVC,BSE CP-14"col-6"	\$ 78.48	\$ 156.95
CSP158	Skirt-PVC,BSE CP-14"col-8"	\$ 86.33	\$ 172.67
CSP454	Skirt-PVC,CRWN-14"col-4"	\$ 58.86	\$ 117.72
CSP455	Skirt-PVC,CRWN-14"col-5"	\$ 80.67	\$ 161.35
CSP456	Skirt-PVC,CRWN-14"col-6"	\$ 91.14	\$ 182.28
CSP656	Skirt-PVC,TSCN-14"col-6"	\$ 79.59	\$ 159.18
CSP658	Skirt-PVC,TSCN-14"col-8"	\$ 92.49	\$ 184.98
CSP65A	Skirt-PVC,TSCN-14"col-10"	\$ 105.40	\$ 210.81
CSP756	Skirt-PVC,CHMFRD-14"col-6"	\$ 68.31	\$ 136.63
CSP758	Skirt-PVC,CHMFRD-14"col-8"	\$ 81.22	\$ 162.43
CSP75A	Skirt-PVC,CHMFRD-14"col-10"	\$ 94.13	\$ 188.25
CSP552	Skirt-PVC,SLD CRWN-14"col-2"	\$ 50.89	\$ 101.78
ASTRG-1414	Astragal-PVC, BSE CP-14" Col	\$ 56.81	

**\*\*PRICES SUBJECT TO CHANGE WITHOUT NOTICE**

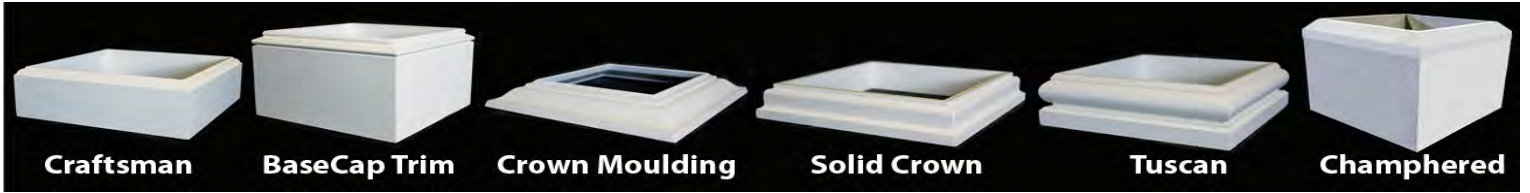



# CUSTOM TAPERED COLUMN LAYOUT

## CLIENT INFORMATION

Dealer Name: \_\_\_\_\_

Project: \_\_\_\_\_

PO#: \_\_\_\_\_

Project Contact: \_\_\_\_\_

Date: \_\_\_\_\_

Approved By: \_\_\_\_\_

## PANEL SIZES

1. Height (Y")
2. Top Width (X")
3. Bottom Width (XX")

**Note:** Tapered column panels are always actual dimensions.

3. Inside Dims

4. Painted    No   
                  Yes

Colour: \_\_\_\_\_

### REVEALS

R\* All bottom and top panel reveals will be adjusted to 2" above and below chosen skirts.

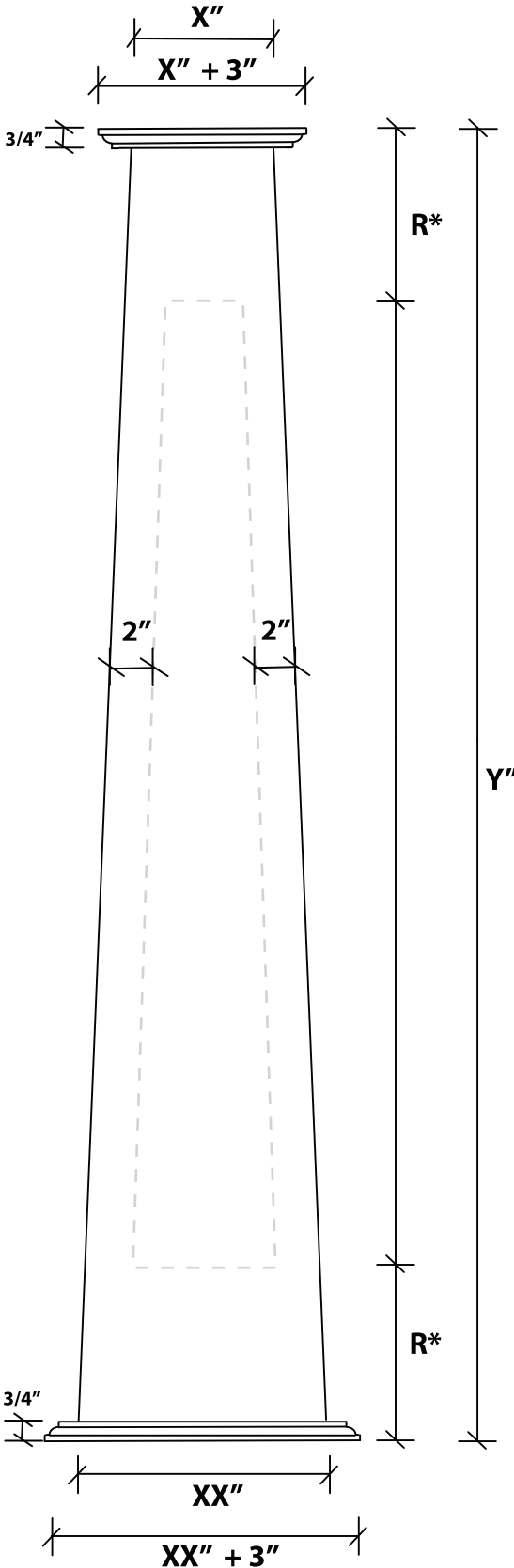

## PANEL PROFILE

1. Plain
  2. Fluted
  3. Raised
  4. Recessed
- Square Edge
  - Round Edge
  - w/ Base Cap Trim
  - Flush Trim
  - Raised Trim

### NOTES:

\_\_\_\_\_  
\_\_\_\_\_  
\_\_\_\_\_

Panel Locks:  M  F

1. Single Panel
2. Double Panel
3. 1/3 - 2/3 Panel
4. Custom \_\_\_\_\_

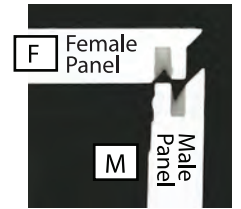

## CAPS & BASES

Place a 'T' for Column Top  
Place 'B' for Column Bottom

### Craftsman

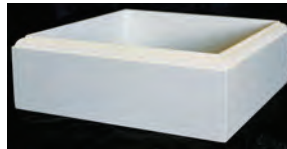

- 4" \_\_\_\_\_
- 6" \_\_\_\_\_
- 8" \_\_\_\_\_
- 10" \_\_\_\_\_

### Chamfered



- 4" \_\_\_\_\_
- 6" \_\_\_\_\_
- 8" \_\_\_\_\_
- 10" \_\_\_\_\_

### Crown Mould



- 4" \_\_\_\_\_
- 5" \_\_\_\_\_
- 6" \_\_\_\_\_

### Base Cap Edge



- 4" \_\_\_\_\_
- 6" \_\_\_\_\_
- 8" \_\_\_\_\_
- 10" \_\_\_\_\_

### Tuscan



- 5" \_\_\_\_\_
- 6" \_\_\_\_\_
- 8" \_\_\_\_\_
- 10" \_\_\_\_\_

### Solid Crown



1. \_\_\_\_\_
2. \_\_\_\_\_

Product Code	Prestige PVC Tapered Columns	Base Width (inches)	Top Width (inches)	Interior Base Width (inches)	Interior Top Width (inches)	Column Height (ft)	Column Weight (lbs)
* CPTPL-0906-048	Prestige Column - PVC, Square Tapered, Plain Panel, 9" x 6" x 4'	9"	6"	8"	5"	48	40
* CPTPL-0906-060	Prestige Column - PVC, Square Tapered, Plain Panel, 9" x 6" x 5'	9"	6"	8"	5"	60	49
* CPTPL-0906-072	Prestige Column - PVC, Square Tapered, Plain Panel, 9" x 6" x 6'	9"	6"	8"	5"	72	49
CPTPL-1208-048	Prestige Column - PVC, Square Tapered, Plain Panel, 12" x 8" x 4'	12"	8"	11"	7"	48	40
CPTPL-1208-060	Prestige Column - PVC, Square Tapered, Plain Panel, 12" x 8" x 5'	12"	8"	11"	7"	60	49
CPTPL-1208-072	Prestige Column - PVC, Square Tapered, Plain Panel, 12" x 8" x 6'	12"	8"	11"	7"	72	49
CPTPL-1309-048	Prestige Column - PVC, Square Tapered, Plain Panel, 13" x 9" x 4'	13"	9"	12"	8"	48	40
CPTPL-1309-060	Prestige Column - PVC, Square Tapered, Plain Panel, 13" x 9" x 5'	13"	9"	12"	8"	60	49
CPTPL-1309-072	Prestige Column - PVC, Square Tapered, Plain Panel, 13" x 9" x 6'	13"	9"	12"	8"	72	49
CPTPL-1612-048	Prestige Column - PVC, Square Tapered, Plain Panel, 16" x 12" x 4'	16"	12"	15"	11"	48	40
CPTPL-1612-060	Prestige Column - PVC, Square Tapered, Plain Panel, 16" x 12" x 5'	16"	12"	15"	11"	60	49
CPTPL-1612-072	Prestige Column - PVC, Square Tapered, Plain Panel, 16" x 12" x 6'	16"	12"	15"	11"	72	49

**NOTE:** \* Will Not Fit Around 6" x 6" PT Wood Structure.

**Packaging-** Standard Kit consists of boxed, 4 column panels, cap/base with adhesive strip, squaring corners, 2 oz. adhesive, fasteners, instructions.

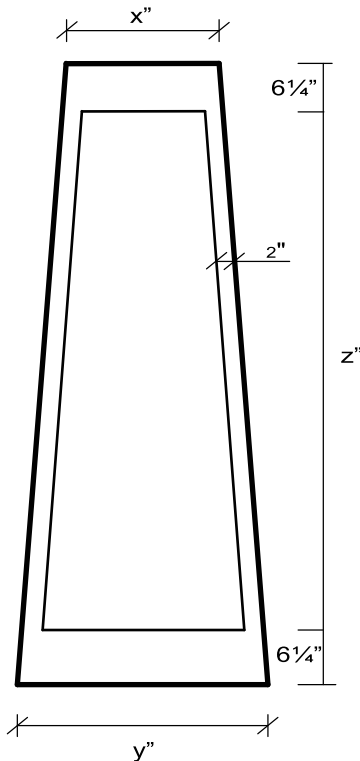

**NOTE:**

- 6" – 10" columns with square edge recessed panels will use either a 3/8" or a 1/2" thick backer panel.
- 12" columns and larger, with square edge recessed panels, will use a 1/2" thick backer panel.
- All columns with recessed panel with base cap trim will use a 5/8" thick column shaft and backer panel.



PRICE LEVEL	
NON-STOCKING	
Standard C&B: 4" Craftsman	
CAP	4" Craftsman Skirt Set
BASE	4" Craftsman Skirt Set
<input checked="" type="checkbox"/> ADD CAP & BASE	

**PRESTIGE COLUMNS - 2017**

**9"- 6" TAPERED COLUMNS**

PRODUCT CODE / SHAFT ONLY
CPTPL-0906048
CPTPL-0906060
CPTPL-0906072
CPTPL-0906096
CPTPL-0906120
CPTPL-0906144

PRODUCT CODE /w 4" SKIRTS
CPTPL-0906048-4K
CPTPL-0906060-4K
CPTPL-0906072-4K
CPTPL-0906096-4K
CPTPL-0906120-4K
CPTPL-0906144-4K

DESCRIPTION
Column - PVC, Tapered, Plain Panel, 9"-6" @ 4'
Column - PVC, Tapered, Plain Panel, 9"-6" @ 5'
Column - PVC, Tapered, Plain Panel, 9"-6" @ 6'
Column - PVC, Tapered, Plain Panel, 9"-6" @ 8'
Column - PVC, Tapered, Plain Panel, 9"-6" @ 10'
Column - PVC, Tapered, Plain Panel, 9"-6" @ 12'

1 PIECE	6 PIECE
\$ 211.25	\$ 198.58
\$ 227.84	\$ 214.17
\$ 244.43	\$ 229.76
\$ 277.61	\$ 260.95
\$ 310.79	\$ 292.14
\$ 344.05	\$ 323.41

**12" - 8" TAPERED COLUMNS**

CPTPL-1208048
CPTPL-1208060
CPTPL-1208072
CPTPL-1208096
CPTPL-1208120
CPTPL-1208144

CPTPL-1208048-4K
CPTPL-1208060-4K
CPTPL-1208072-4K
CPTPL-1208096-4K
CPTPL-1208120-4K
CPTPL-1208144-4K

Column - PVC, Tapered, Plain Panel, 12"-8" @ 4'
Column - PVC, Tapered, Plain Panel, 12"-8" @ 5'
Column - PVC, Tapered, Plain Panel, 12"-8" @ 6'
Column - PVC, Tapered, Plain Panel, 12"-8" @ 8'
Column - PVC, Tapered, Plain Panel, 12"-8" @ 10'
Column - PVC, Tapered, Plain Panel, 12"-8" @ 12'

\$ 238.58	\$ 224.26
\$ 260.69	\$ 245.05
\$ 282.81	\$ 265.84
\$ 327.05	\$ 307.43
\$ 371.29	\$ 349.02
\$ 415.65	\$ 390.71

**13" - 9" TAPERED COLUMNS**

CPTPL-1309048
CPTPL-1309060
CPTPL-1309072
CPTPL-1309096
CPTPL-1309120
CPTPL-1309144

CPTPL-1309048-4K
CPTPL-1309060-4K
CPTPL-1309072-4K
CPTPL-1309096-4K
CPTPL-1309120-4K
CPTPL-1309144-4K

Column - PVC, Tapered, Plain Panel, 13"-9" @ 4'
Column - PVC, Tapered, Plain Panel, 13"-9" @ 5'
Column - PVC, Tapered, Plain Panel, 13"-9" @ 6'
Column - PVC, Tapered, Plain Panel, 13"-9" @ 8'
Column - PVC, Tapered, Plain Panel, 13"-9" @ 10'
Column - PVC, Tapered, Plain Panel, 13"-9" @ 12'

\$ 249.48	\$ 234.51
\$ 273.80	\$ 257.37
\$ 298.14	\$ 280.25
\$ 346.81	\$ 326.00
\$ 395.47	\$ 371.75
\$ 444.26	\$ 417.61

**16" - 12" TAPERED COLUMNS**

CPTPL-1612048
CPTPL-1612060
CPTPL-1612072
CPTPL-1612096
CPTPL-1612120
CPTPL-1612144

CPTPL-1612048-4K
CPTPL-1612060-4K
CPTPL-1612072-4K
CPTPL-1612096-4K
CPTPL-1612120-4K
CPTPL-1612144-4K

Column - PVC, Tapered, Plain Panel, 16"-12" @ 4'
Column - PVC, Tapered, Plain Panel, 16"-12" @ 5'
Column - PVC, Tapered, Plain Panel, 16"-12" @ 6'
Column - PVC, Tapered, Plain Panel, 16"-12" @ 8'
Column - PVC, Tapered, Plain Panel, 16"-12" @ 10'
Column - PVC, Tapered, Plain Panel, 16"-12" @ 12'

\$ 282.12	\$ 265.19
\$ 313.09	\$ 294.30
\$ 344.05	\$ 323.41
\$ 406.00	\$ 381.64
\$ 467.93	\$ 439.85
\$ 530.02	\$ 498.22

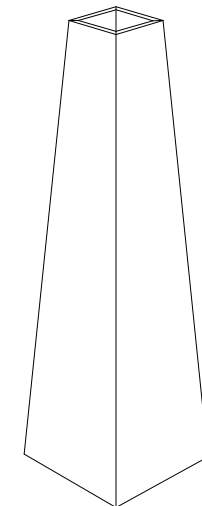

**TAPERED PLAIN**

\*12% FOR CUSTOM HEIGHT  
\*\*PRICES SUBJECT TO CHANGE WITHOUT NOTICE

DIMS			
OUTSIDE		INSIDE	
TOP	BOTTOM	TOP	BOTTOM
6"	9"	5"	8"
8"	12"	7"	11"
9"	13"	8"	12"
12"	16"	11"	15"

**SQUARING "L" INCLUDED**



\*Adds 3" to Outside Dims



PRICE LEVEL	
NON-STOCKING	
Standard C&B: 4" Craftsman	
CAP	4" Craftsman Skirt Set
BASE	4" Craftsman Skirt Set
<input checked="" type="checkbox"/> ADD CAP & BASE	

**PRESTIGE COLUMNS - 2017**

**9"- 6" TAPERED COLUMNS**

PRODUCT CODE / SHAFT ONLY
CPTRA-0906048
CPTRA-0906060
CPTRA-0906072
CPTRA-0906096
CPTRA-0906120
CPTRA-0906144

PRODUCT CODE /w 4" SKIRTS
CPTRA-0906048-4K
CPTRA-0906060-4K
CPTRA-0906072-4K
CPTRA-0906096-4K
CPTRA-0906120-4K
CPTRA-0906144-4K

DESCRIPTION
Column - PVC, Tapered, Raised Panel, 9"-6" @ 4'
Column - PVC, Tapered, Raised Panel, 9"-6" @ 5'
Column - PVC, Tapered, Raised Panel, 9"-6" @ 6'
Column - PVC, Tapered, Raised Panel, 9"-6" @ 8'
Column - PVC, Tapered, Raised Panel, 9"-6" @ 10'
Column - PVC, Tapered, Raised Panel, 9"-6" @ 12'

1 PIECE	6 PIECE
\$ 249.06	\$ 234.11
\$ 265.66	\$ 249.72
\$ 282.24	\$ 265.30
\$ 316.47	\$ 297.48
\$ 348.59	\$ 327.68
\$ 381.87	\$ 358.96

**12" - 8" TAPERED COLUMNS**

CPTRA-1208048
CPTRA-1208060
CPTRA-1208072
CPTRA-1208096
CPTRA-1208120
CPTRA-1208144

CPTRA-1208048-4K
CPTRA-1208060-4K
CPTRA-1208072-4K
CPTRA-1208096-4K
CPTRA-1208120-4K
CPTRA-1208144-4K

Column - PVC, Tapered, Raised Panel, 12"-8" @ 4'
Column - PVC, Tapered, Raised Panel, 12"-8" @ 5'
Column - PVC, Tapered, Raised Panel, 12"-8" @ 6'
Column - PVC, Tapered, Raised Panel, 12"-8" @ 8'
Column - PVC, Tapered, Raised Panel, 12"-8" @ 10'
Column - PVC, Tapered, Raised Panel, 12"-8" @ 12'

\$ 276.38	\$ 259.80
\$ 298.49	\$ 280.58
\$ 320.62	\$ 301.38
\$ 364.86	\$ 342.97
\$ 409.10	\$ 384.55
\$ 453.45	\$ 426.24

**13" - 9" TAPERED COLUMNS**

CPTRA-1309048
CPTRA-1309060
CPTRA-1309072
CPTRA-1309096
CPTRA-1309120
CPTRA-1309144

CPTRA-1309048-4K
CPTRA-1309060-4K
CPTRA-1309072-4K
CPTRA-1309096-4K
CPTRA-1309120-4K
CPTRA-1309144-4K

Column - PVC, Tapered, Raised Panel, 13"-9" @ 4'
Column - PVC, Tapered, Raised Panel, 13"-9" @ 5'
Column - PVC, Tapered, Raised Panel, 13"-9" @ 6'
Column - PVC, Tapered, Raised Panel, 13"-9" @ 8'
Column - PVC, Tapered, Raised Panel, 13"-9" @ 10'
Column - PVC, Tapered, Raised Panel, 13"-9" @ 12'

\$ 287.29	\$ 270.05
\$ 311.63	\$ 292.93
\$ 335.96	\$ 315.80
\$ 384.62	\$ 361.54
\$ 433.29	\$ 407.29
\$ 482.08	\$ 453.15

**16" - 12" TAPERED COLUMNS**

CPTRA-1612048
CPTRA-1612060
CPTRA-1612072
CPTRA-1612096
CPTRA-1612120
CPTRA-1612144

CPTRA-1612048-4K
CPTRA-1612060-4K
CPTRA-1612072-4K
CPTRA-1612096-4K
CPTRA-1612120-4K
CPTRA-1612144-4K

Column - PVC, Tapered, Raised Panel, 16"-12" @ 4'
Column - PVC, Tapered, Raised Panel, 16"-12" @ 5'
Column - PVC, Tapered, Raised Panel, 16"-12" @ 6'
Column - PVC, Tapered, Raised Panel, 16"-12" @ 8'
Column - PVC, Tapered, Raised Panel, 16"-12" @ 10'
Column - PVC, Tapered, Raised Panel, 16"-12" @ 12'

\$ 319.93	\$ 300.74
\$ 350.89	\$ 329.84
\$ 381.87	\$ 358.95
\$ 443.81	\$ 417.18
\$ 505.73	\$ 475.39
\$ 567.84	\$ 533.77

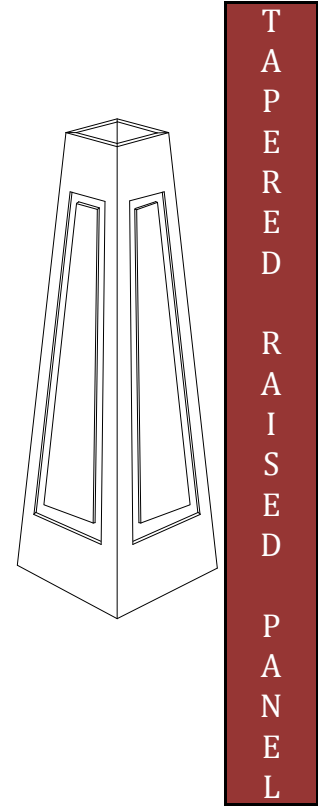

\*12% FOR CUSTOM HEIGHT  
\*\*PRICES SUBJECT TO CHANGE WITHOUT NOTICE

DIMS			
OUTSIDE		INSIDE	
TOP	BOTTOM	TOP	BOTTOM
6"	9"	5"	8"
8"	12"	7"	11"
9"	13"	8"	12"
12"	16"	11"	15"

**SQUARING "L" INCLUDED**



\*Adds 3" to Outside Dims





PRICE LEVEL	
NON-STOCKING	
Standard C&B: 4" Craftsman	
CAP	4" Craftsman Skirt Set
BASE	4" Craftsman Skirt Set
<input checked="" type="checkbox"/> ADD CAP & BASE	

**PRESTIGE COLUMNS - 2017**

12" - 8" TAPERED COLUMNS

PRODUCT CODE / SHAFT ONLY
CPTRS-1208048
CPTRS-1208060
CPTRS-1208072
CPTRS-1208096
CPTRS-1208120
CPTRS-1208144

PRODUCT CODE /w 4" SKIRTS
CPTRS-1208048-4K
CPTRS-1208060-4K
CPTRS-1208072-4K
CPTRS-1208096-4K
CPTRS-1208120-4K
CPTRS-1208144-4K

DESCRIPTION
Column - PVC, Tapered, Recessed Square Edge Panel, 12"-8" @ 4'
Column - PVC, Tapered, Recessed Square Edge Panel, 12"-8" @ 5'
Column - PVC, Tapered, Recessed Square Edge Panel, 12"-8" @ 6'
Column - PVC, Tapered, Recessed Square Edge Panel, 12"-8" @ 8'
Column - PVC, Tapered, Recessed Square Edge Panel, 12"-8" @ 10'
Column - PVC, Tapered, Recessed Square Edge Panel, 12"-8" @ 12'

	1 PIECE	6 PIECE
\$	297.15	279.32
\$	333.85	313.82
\$	370.53	348.30
\$	443.94	417.30
\$	517.33	486.29
\$	590.84	555.39

13" - 9" TAPERED COLUMNS

CPTRS-1309048
CPTRS-1309060
CPTRS-1309072
CPTRS-1309096
CPTRS-1309120
CPTRS-1309144

CPTRS-1309048-4K
CPTRS-1309060-4K
CPTRS-1309072-4K
CPTRS-1309096-4K
CPTRS-1309120-4K
CPTRS-1309144-4K

Column - PVC, Tapered, Recessed Square Edge Panel, 13"-9" @ 4'
Column - PVC, Tapered, Recessed Square Edge Panel, 13"-9" @ 5'
Column - PVC, Tapered, Recessed Square Edge Panel, 13"-9" @ 6'
Column - PVC, Tapered, Recessed Square Edge Panel, 13"-9" @ 8'
Column - PVC, Tapered, Recessed Square Edge Panel, 13"-9" @ 10'
Column - PVC, Tapered, Recessed Square Edge Panel, 13"-9" @ 12'

\$	311.66	292.96
\$	352.29	331.16
\$	392.92	369.34
\$	474.18	445.73
\$	555.45	522.12
\$	636.83	598.62

16" - 12" TAPERED COLUMNS

CPTRS-1612048
CPTRS-1612060
CPTRS-1612072
CPTRS-1612096
CPTRS-1612120
CPTRS-1612144

CPTRS-1612048-4K
CPTRS-1612060-4K
CPTRS-1612072-4K
CPTRS-1612096-4K
CPTRS-1612120-4K
CPTRS-1612144-4K

Column - PVC, Tapered, Recessed Square Edge Panel, 16"-12" @ 4'
Column - PVC, Tapered, Recessed Square Edge Panel, 16"-12" @ 5'
Column - PVC, Tapered, Recessed Square Edge Panel, 16"-12" @ 6'
Column - PVC, Tapered, Recessed Square Edge Panel, 16"-12" @ 8'
Column - PVC, Tapered, Recessed Square Edge Panel, 16"-12" @ 10'
Column - PVC, Tapered, Recessed Square Edge Panel, 16"-12" @ 12'

\$	355.32	334.00
\$	407.75	383.28
\$	460.18	432.57
\$	565.04	531.14
\$	669.89	629.70
\$	774.91	728.41

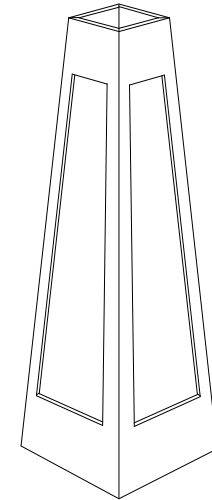

T  
A  
P  
E  
R  
E  
D  
  
R  
E  
C  
E  
S  
S  
E  
D  
  
S  
Q  
U  
A  
R  
E  
  
E  
D  
G  
E

\*12% FOR CUSTOM HEIGHT  
\*\*PRICES SUBJECT TO CHANGE WITHOUT NOTICE

**DIMS**

OUTSIDE		INSIDE	
TOP	BOTTOM	TOP	BOTTOM
6"	9"	5"	8"
8"	12"	7"	11"
9"	13"	8"	12"
12"	16"	11"	15"

**SQUARING "L" INCLUDED**



\*Adds 3" to Outside Dims



PRICE LEVEL	
NON-STOCKING	
Standard C&B: 4" Craftsman	
CAP	4" Craftsman Skirt Set
BASE	4" Craftsman Skirt Set
<input checked="" type="checkbox"/> ADD CAP & BASE	

**PRESTIGE COLUMNS - 2017**

**12" - 8" TAPERED COLUMNS**

PRODUCT CODE / SHAFT ONLY
CPTRBF-1208048
CPTRBF-1208060
CPTRBF-1208072
CPTRBF-1208096
CPTRBF-1208120
CPTRBF-1208144

PRODUCT CODE
CPTRBF-1208048-4K
CPTRBF-1208060-4K
CPTRBF-1208072-4K
CPTRBF-1208096-4K
CPTRBF-1208120-4K
CPTRBF-1208144-4K

DESCRIPTION
Column - PVC, Tapered, Recessed Flush Trim Panel, 12"-8" @ 4'
Column - PVC, Tapered, Recessed Flush Trim Panel, 12"-8" @ 5'
Column - PVC, Tapered, Recessed Flush Trim Panel, 12"-8" @ 6'
Column - PVC, Tapered, Recessed Flush Trim Panel, 12"-8" @ 8'
Column - PVC, Tapered, Recessed Flush Trim Panel, 12"-8" @ 10'
Column - PVC, Tapered, Recessed Flush Trim Panel, 12"-8" @ 12'

	1 PIECE	6 PIECE
\$	355.07	\$ 333.77
\$	391.25	\$ 367.78
\$	427.43	\$ 401.79
\$	499.81	\$ 469.82
\$	572.18	\$ 537.85
\$	644.66	\$ 605.98

**13" - 9" TAPERED COLUMNS**

CPTRBF-1309048
CPTRBF-1309060
CPTRBF-1309072
CPTRBF-1309096
CPTRBF-1309120
CPTRBF-1309144

CPTRBF-1309048-4K
CPTRBF-1309060-4K
CPTRBF-1309072-4K
CPTRBF-1309096-4K
CPTRBF-1309120-4K
CPTRBF-1309144-4K

Column - PVC, Tapered, Recessed Flush Trim Panel, 13"-9" @ 4'
Column - PVC, Tapered, Recessed Flush Trim Panel, 13"-9" @ 5'
Column - PVC, Tapered, Recessed Flush Trim Panel, 13"-9" @ 6'
Column - PVC, Tapered, Recessed Flush Trim Panel, 13"-9" @ 8'
Column - PVC, Tapered, Recessed Flush Trim Panel, 13"-9" @ 10'
Column - PVC, Tapered, Recessed Flush Trim Panel, 13"-9" @ 12'

\$	368.31	\$ 346.21
\$	406.71	\$ 382.31
\$	445.11	\$ 418.40
\$	521.89	\$ 490.57
\$	598.69	\$ 562.77
\$	675.61	\$ 635.07

**16" - 12" TAPERED COLUMNS**

CPTRBF-1612048
CPTRBF-1612060
CPTRBF-1612072
CPTRBF-1612096
CPTRBF-1612120
CPTRBF-1612144

CPTRBF-1612048-4K
CPTRBF-1612060-4K
CPTRBF-1612072-4K
CPTRBF-1612096-4K
CPTRBF-1612120-4K
CPTRBF-1612144-4K

Column - PVC, Tapered, Recessed Flush Trim Panel, 16"-12" @ 4'
Column - PVC, Tapered, Recessed Flush Trim Panel, 16"-12" @ 5'
Column - PVC, Tapered, Recessed Flush Trim Panel, 16"-12" @ 6'
Column - PVC, Tapered, Recessed Flush Trim Panel, 16"-12" @ 8'
Column - PVC, Tapered, Recessed Flush Trim Panel, 16"-12" @ 10'
Column - PVC, Tapered, Recessed Flush Trim Panel, 16"-12" @ 12'

\$	402.47	\$ 378.32
\$	447.50	\$ 420.65
\$	492.52	\$ 462.97
\$	582.59	\$ 547.63
\$	672.65	\$ 632.29
\$	762.88	\$ 717.11

**\*12% FOR CUSTOM HEIGHT  
\*\*PRICES SUBJECT TO CHANGE WITHOUT NOTICE**

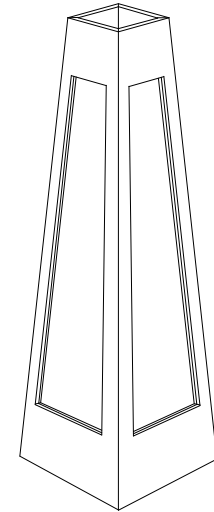

**T  
A  
P  
E  
R  
E  
D  
  
R  
E  
C  
E  
S  
S  
E  
D  
  
F  
L  
U  
S  
H  
  
T  
R  
I  
M**

DIMS			
OUTSIDE		INSIDE	
TOP	BOTTOM	TOP	BOTTOM
8"	12"	7"	11"
9"	13"	8"	12"
12"	16"	11"	15"

**SQUARING "L" INCLUDED**



**\*Adds 3" to Outside Dims**



**PRESTIGE COLUMNS**

T  
A  
P  
E  
R  
E  
D  
  
C  
A  
P  
  
&  
  
B  
A  
S  
E  
  
O  
P  
T  
I  
O  
N  
S

	PRODUCT CODE	DESCRIPTION	STANDARD PACKAGE
<u>9" - 6" TAPERED COLUMNS</u>	CSP3C14T	Skirt-PVC,CMN-9"-6"Col-4" SET	\$ 16.18
	CSP3C16T	Skirt-PVC,CMN-9"-6"Col-6" SET	\$ 24.97
	CSP3C18T	Skirt-PVC,CMN-9"-6"Col-8" SET	\$ 29.10
	CSP5C1T	Skirt-PVC,SLD CRWN-9"-6"Col SET	\$ 36.18
<u>12" - 8" TAPERED COLUMNS</u>	CSP3424T	Skirt-PVC,CMN-12"-8"Col-4" SET	\$ 18.61
	CSP3426T	Skirt-PVC,CMN-12"-8"Col-6" SET	\$ 28.68
	CSP3428T	Skirt-PVC,CMN-12"-8"Col-8" SET	\$ 34.00
	CSP542T	Skirt-PVC,SLD CRWN-12"-8"Col SET	\$ 40.80
<u>13" - 9" TAPERED COLUMNS</u>	CSP3DC4T	Skirt-PVC,CMN-13"-9"Col-4" SET	\$ 19.55
	CSP3DC6T	Skirt-PVC,CMN-13"-9"Col-6" SET	\$ 30.17
	CSP3DC28T	Skirt-PVC,CMN-13"-9"Col-8" SET	\$ 35.94
	CSP5DCT	Skirt-PVC,SLD CRWN-13"-9"Col SET	\$ 42.64
<u>16" - 12" TAPERED COLUMNS</u>	CSP3644T	Skirt-PVC,CMN-16"-12"Col-4" SET	\$ 22.49
	CSP3646T	Skirt-PVC,CMN-16"-12"Col-6" SET	\$ 31.02
	CSP3648T	Skirt-PVC,CMN-16"-12"Col-8" SET	\$ 38.50
	CSP564T	Skirt-PVC,SLD CRWN-16"-12"Col SET	\$ 45.04

**\*\*PRICES SUBJECT TO CHANGE WITHOUT NOTICE**





Innovative PVC Systems

# P R E M I U M C O L U M N S T Y L E S



*Columns shown above are Edgewater I.*

## *The Prestige Advantage*™

### Beautiful

- Classic Architectural Look
- No Visible Fasteners
- Wide Assortment of Styles

### Easy Installation

- Complete Kit, with Fasteners & Adhesive
- No Special Tools Needed
- Easy Innovative SmartLock™ Corners
- Flat-Pack for Safe & Easy Transportation

### Virtually Maintenance Free

- Free-Foam Cellular PVC Construction
- Weather, Decay and Insect Resistant
- Paint Friendly with Acrylic Latex Paints

## Smart & Beautiful

Prestige Columns™ feature beautiful, unblemished column panel faces. Each panel incorporates our innovative SmartLock™ Corner technology, resulting in a column that is assembled without the need for nails or screws marring the panel face.

The PREMIUM COLUMN SERIES™ reflects style of elegance that has been produced over the years for architects and builders as repeat custom profiles that have earned their place in the series.







Innovative PVC Systems

# P R E M I U M C O L U M N S T Y L E S



Cochren Flare I

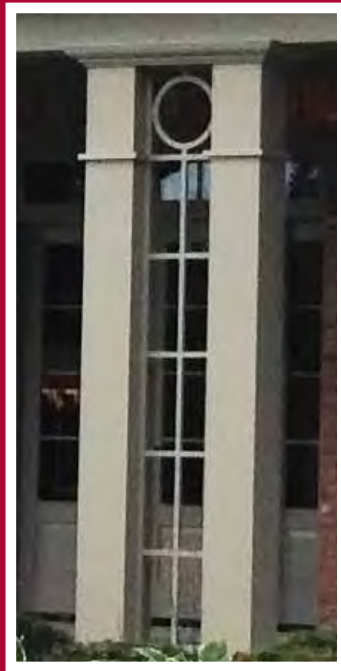

Cochren Flare II

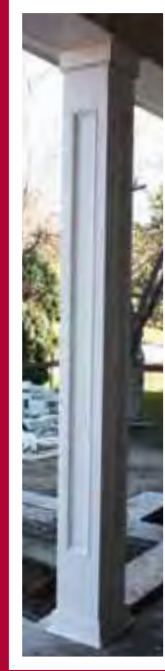

Bayside I



Bayview I

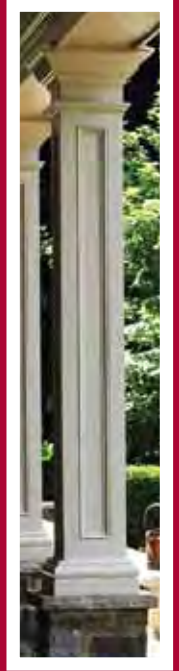

Edgewater I



Riverside I

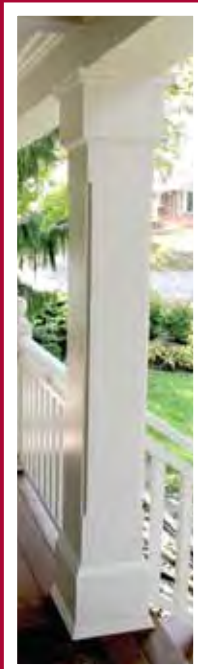

Unique Flare I



Blue Water I



Lakeside I



Bayshore II





**PRESTIGE PREMIUM COLUMNS - 2017**

**P R E S T I G E P R E M I U M**

BAYSHORE II

PRODUCT CODE	DESCRIPTION	STANDARD PACKAGE
CPSRS2-08096	Column - PVC, Square Edge, Double Recessed Panel, 8" @ 8' /w 4" Craftsman Cap & 8" Craftsman Base	\$ 346.06
CPSRS2-10096	Column - PVC, Square Edge, Double Recessed Panel, 10" @ 8' /w 4" Craftsman Cap & 8" Craftsman Base	\$ 414.00
CPSRS2-12120	Column - PVC, Square Edge, Double Recessed Panel, 12" @ 10' /w 4" Craftsman Skirt & 8" Craftsman Base	\$ 546.81

LAKESIDE I

CPSRBF4-08096	Column - PVC, Square, Recessed Flush Trim Panel - 50/50, 8" @ 8' /w 4" Craftsman Skirts	\$ 466.56
CPSRBF4-10096	Column - PVC, Square, Recessed Flush Trim Panel - 50/50, 10" @ 8' /w 4" Craftsman Skirts	\$ 517.90
CPSRBF4-12120	Column - PVC, Square, Recessed Flush Trim Panel - 50/50, 12" @ 10' /w 4" Craftsman Skirts	\$ 663.54

BAYSIDE I

CPSRBF1-08096	Column - PVC, Square, Recessed Flush Trim Single Panel, 8" @ 8' /w 4" Craftsman Skirts	\$ 427.59
CPSRBF1-10096	Column - PVC, Square, Recessed Flush Trim Single Panel, 10" @ 8' /w 4" Craftsman Skirts	\$ 474.60
CPSRBF1-12120	Column - PVC, Square, Recessed Flush Trim Single Panel, 12" @ 10' /w 4" Craftsman Skirts	\$ 607.32

RIVERSIDE I

CPSRBF3-08096	Column - PVC, Square, Recessed Flush Trim Panel - 1/2 - 2/3, 8" @ 8' /w 5" Crown Cap, 8" Base Cap Skirt & Base Cap Astragal	\$ 556.93
CPSRBF3-10096	Column - PVC, Square, Recessed Flush Trim Panel - 1/2 - 2/3, 10" @ 8' /w 5" Crown Cap, 8" Base Cap Skirt & Base Cap Astragal	\$ 619.77
CPSRBF3-12120	Column - PVC, Square, Recessed Flush Trim Panel - 1/2 - 2/3, 12" @ 10' /w 5" Crown Cap, 8" Base Cap Skirt & Base Cap Astragal	\$ 776.93

EDGEWATER I

CPSRBF1-08096	Column - PVC, Square, Recessed Flush Trim Single Panel, 8" @ 8' /w 6" Crown Cap, 6" PVC Tuscan Skirt & Base Cap Astragal	\$ 498.23
CPSRBF1-10096	Column - PVC, Square, Recessed Flush Trim Single Panel, 10" @ 8' /w 6" Crown Cap, 6" PVC Tuscan Skirt & Base Cap Astragal	\$ 549.52
CPSRBF1-12120	Column - PVC, Square, Recessed Flush Trim Single Panel, 12" @ 10' /w 6" Crown Cap, 6" PVC Tuscan Skirt & Base Cap Astragal	\$ 686.58

BAYVIEW I

CPSRBF1-08096	Column - PVC, Square, Recessed Flush Trim Single Panel, 8" @ 8' /w 5" Crown Cap, 8" Base Cap Skirt & Base Cap Astragal	\$ 517.97
CPSRBF1-10096	Column - PVC, Square, Recessed Flush Trim Single Panel, 10" @ 8' /w 5" Crown Cap, 8" Base Cap Skirt & Base Cap Astragal	\$ 576.47
CPSRBF1-12120	Column - PVC, Square, Recessed Flush Trim Single Panel, 12" @ 10' /w 5" Crown Cap, 8" Base Cap Skirt & Base Cap Astragal	\$ 720.71

COCHREN FLARE I

CPSPLDC12-08096	Column - PVC, Square, Plain Panel /w Double 12" Lattice, 8" @ 8' /w 5" Crown Mould Cap, 6" PVC Tuscan Base & 1" Astraga	\$ 1,262.34
CPSPLDC12-10096	Column - PVC, Square, Plain Panel /w Double 12" Lattice, 10" @ 8' /w 5" Crown Mould Cap, 6" PVC Tuscan Base & 1" Astraga	\$ 1,382.62
CPSPLDC12-12120	Column - PVC, Square, Plain Panel /w Double 12" Lattice, 12" @ 10' /w 5" Crown Mould Cap, 6" PVC Tuscan Base & 1" Astraga	\$ 1,781.99

COCHREN FLARE II

CPSPLS12-08096	Column - PVC, Square, Plain Panel /w Single 12" Lattice, 8" @ 8' /w 5" Crown Mould Cap, 6" PVC Tuscan Base & 1" Astragal	\$ 766.15
CPSPLS12-10096	Column - PVC, Square, Plain Panel /w Single 12" Lattice, 10" @ 8' /w 5" Crown Mould Cap, 6" PVC Tuscan Base & 1" Astraga	\$ 852.54
CPSPLS12-12120	Column - PVC, Square, Plain Panel /w Single 12" Lattice, 12" @ 10' /w 5" Crown Mould Cap, 6" PVC Tuscan Base & 1" Astraga	\$ 1,094.75

UNIQUE FLARE

CPSCH-08096	Column - PVC, Square, Chamfered Plain Panel, 8" @ 8' /w 4/4" x 8" Chamfered Cap & 4/4" x 10" Chamfered Base	\$ 395.88
CPSCH-10096	Column - PVC, Square, Chamfered Plain Panel, 10" @ 8' /w 4/4" x 8" Chamfered Cap & 4/4" x 10" Chamfered Base	\$ 480.20
CPSCH-12120	Column - PVC, Square, Chamfered Plain Panel, 12" @ 10' /w 4/4" x 8" Chamfered Cap & 4/4" x 10" Chamfered Base	\$ 673.53

**DIMS**

SIZE	OUTSIDE
6"	5-1/2"
8"	7-1/4"
10"	9-3/8"
12"	11-1/2"
14"	13-1/4"

**SQUARING "L" INCLUDED**



\*Adds 3" to Outside Dims

\*12% FOR CUSTOM HEIGHT & 12% FOR ACTUAL WIDTH  
 \*\*\*FOR COLUMNS LARGER THAN 14" PLEASE CONTACT YOUR LOCAL PRESTIGE DEALER  
 \*\*PRICES SUBJECT TO CHANGE WITHOUT NOTICE



**PRESTIGE COLUMNS - 2017**

**8" COLUMNS**

PRODUCT CODE	DESCRIPTION	1 PIECE	6 PIECE
CPSCH-08048	Column - PVC, Square, Chamfered Plain Panel, 8" @ 4'	\$ 301.88	\$ 283.77
CPSCH-08060	Column - PVC, Square, Chamfered Plain Panel, 8" @ 5'	\$ 345.48	\$ 324.75
CPSCH-08072	Column - PVC, Square, Chamfered Plain Panel, 8" @ 6'	\$ 389.06	\$ 365.71
CPSCH-08096	Column - PVC, Square, Chamfered Plain Panel, 8" @ 8'	\$ 476.23	\$ 447.66
CPSCH-08108	Column - PVC, Square, Chamfered Plain Panel, 8" @ 9'	\$ 519.82	\$ 488.63
CPSCH-08120	Column - PVC, Square, Chamfered Plain Panel, 8" @ 10'	\$ 563.40	\$ 529.60
CPSCH-08144	Column - PVC, Square, Chamfered Plain Panel, 8" @ 12'	\$ 650.58	\$ 611.54

**10" COLUMNS**

CPSCH-10048	Column - PVC, Square, Chamfered Plain Panel, 10" @ 4'	\$ 359.47	\$ 337.90
CPSCH-10060	Column - PVC, Square, Chamfered Plain Panel, 10" @ 5'	\$ 413.96	\$ 389.12
CPSCH-10072	Column - PVC, Square, Chamfered Plain Panel, 10" @ 6'	\$ 468.45	\$ 440.34
CPSCH-10096	Column - PVC, Square, Chamfered Plain Panel, 10" @ 8'	\$ 577.43	\$ 542.78
CPSCH-10108	Column - PVC, Square, Chamfered Plain Panel, 10" @ 9'	\$ 631.93	\$ 594.01
CPSCH-10120	Column - PVC, Square, Chamfered Plain Panel, 10" @ 10'	\$ 686.42	\$ 645.23
CPSCH-10144	Column - PVC, Square, Chamfered Plain Panel, 10" @ 12'	\$ 795.40	\$ 747.67

**12" COLUMNS**

CPSCH-12048	Column - PVC, Square, Chamfered Plain Panel, 12" @ 4'	\$ 417.04	\$ 392.01
CPSCH-12060	Column - PVC, Square, Chamfered Plain Panel, 12" @ 5'	\$ 482.43	\$ 453.49
CPSCH-12072	Column - PVC, Square, Chamfered Plain Panel, 12" @ 6'	\$ 547.83	\$ 514.96
CPSCH-12096	Column - PVC, Square, Chamfered Plain Panel, 12" @ 8'	\$ 678.63	\$ 637.91
CPSCH-12108	Column - PVC, Square, Chamfered Plain Panel, 12" @ 9'	\$ 744.02	\$ 699.37
CPSCH-12120	Column - PVC, Square, Chamfered Plain Panel, 12" @ 10'	\$ 809.41	\$ 760.85
CPSCH-12144	Column - PVC, Square, Chamfered Plain Panel, 12" @ 12'	\$ 940.21	\$ 883.80

**14" COLUMNS**

CPSCH-14048	Column - PVC, Square, Chamfered Plain Panel, 14" @ 4'	\$ 512.67	\$ 481.91
CPSCH-14060	Column - PVC, Square, Chamfered Plain Panel, 14" @ 5'	\$ 547.04	\$ 514.22
CPSCH-14072	Column - PVC, Square, Chamfered Plain Panel, 14" @ 6'	\$ 623.34	\$ 585.94
CPSCH-14096	Column - PVC, Square, Chamfered Plain Panel, 14" @ 8'	\$ 775.91	\$ 729.35
CPSCH-14108	Column - PVC, Square, Chamfered Plain Panel, 14" @ 9'	\$ 852.20	\$ 801.07
CPSCH-14120	Column - PVC, Square, Chamfered Plain Panel, 14" @ 10'	\$ 928.49	\$ 872.78
CPSCH-14144	Column - PVC, Square, Chamfered Plain Panel, 14" @ 12'	\$ 1,081.07	\$ 1,016.21

PRICE LEVEL	
NON-STOCKING	
Standard C&B: Chamfered 8" CP & 10 BSE	
CAP	8" Chamfered (4/4")
BASE	10" Chamfered (4/4")
<input checked="" type="checkbox"/> ADD CAP & BASE	

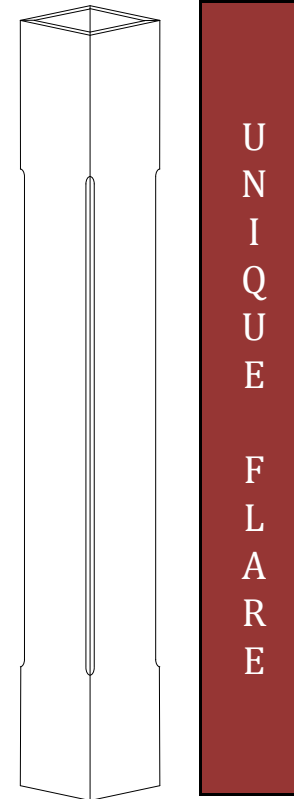

\*12% FOR CUSTOM HEIGHT & 12% FOR ACTUAL WIDTH  
 \*\*\*FOR COLUMNS LARGER THAN 14" PLEASE CONTACT YOUR LOCAL PRESTIGE DEALER  
 \*\*PRICES SUBJECT TO CHANGE WITHOUT NOTICE

SIZE	DIMS	
	OUTSIDE	INSIDE
6"	5-1/2"	3-1/2"
8"	7-1/4"	5-1/4"
10"	9-3/8"	7-3/8"
12"	11-1/2"	9-1/2"
14"	13-1/4"	11-1/4"

**SQUARING "L" INCLUDED**



\*Adds 3" to Outside Dims



**PRESTIGE COLUMNS - 2017**



PRICE LEVEL	
NON-STOCKING	
Standard C&B: 5" CRWN CP & 6" TSCN BSE	
CAP	5" Crown Mould
BASE	PVC Tuscan 6"
<input checked="" type="checkbox"/> ADD CAP & BASE	

**8" COLUMNS**

PRODUCT CODE	DESCRIPTION
CPSPLS12-08048	Column - PVC, Square, Plain Panel /w Single 12" Lattice, 8" @ 4'
CPSPLS12-08060	Column - PVC, Square, Plain Panel /w Single 12" Lattice, 8" @ 5'
CPSPLS12-08072	Column - PVC, Square, Plain Panel /w Single 12" Lattice, 8" @ 6'
CPSPLS12-08096	Column - PVC, Square, Plain Panel /w Single 12" Lattice, 8" @ 8'
CPSPLS12-08108	Column - PVC, Square, Plain Panel /w Single 12" Lattice, 8" @ 9'
CPSPLS12-08120	Column - PVC, Square, Plain Panel /w Single 12" Lattice, 8" @ 10'
CPSPLS12-08144	Column - PVC, Square, Plain Panel /w Single 12" Lattice, 8" @ 12'

1 PIECE	6 PIECE
\$ 610.27	\$ 573.66
\$ 698.32	\$ 656.42
\$ 756.82	\$ 711.42
\$ 903.38	\$ 849.17
\$ 976.12	\$ 917.56
\$ 1,049.93	\$ 986.93
\$ 1,196.70	\$ 1,124.90

**10" COLUMNS**

CPSPLS12-10048	Column - PVC, Square, Plain Panel /w Single 12" Lattice, 10" @ 4'
CPSPLS12-10060	Column - PVC, Square, Plain Panel /w Single 12" Lattice, 10" @ 5'
CPSPLS12-10072	Column - PVC, Square, Plain Panel /w Single 12" Lattice, 10" @ 6'
CPSPLS12-10096	Column - PVC, Square, Plain Panel /w Single 12" Lattice, 10" @ 8'
CPSPLS12-10108	Column - PVC, Square, Plain Panel /w Single 12" Lattice, 10" @ 9'
CPSPLS12-10120	Column - PVC, Square, Plain Panel /w Single 12" Lattice, 10" @ 10'
CPSPLS12-10144	Column - PVC, Square, Plain Panel /w Single 12" Lattice, 10" @ 12'

\$ 663.92	\$ 624.09
\$ 762.91	\$ 717.14
\$ 832.33	\$ 782.39
\$ 1,000.74	\$ 940.70
\$ 1,084.94	\$ 1,019.84
\$ 1,169.15	\$ 1,099.00
\$ 1,337.84	\$ 1,257.57

**12" COLUMNS**

CPSPLS12-12048	Column - PVC, Square, Plain Panel /w Single 12" Lattice, 12" @ 4'
CPSPLS12-12060	Column - PVC, Square, Plain Panel /w Single 12" Lattice, 12" @ 5'
CPSPLS12-12072	Column - PVC, Square, Plain Panel /w Single 12" Lattice, 12" @ 6'
CPSPLS12-12096	Column - PVC, Square, Plain Panel /w Single 12" Lattice, 12" @ 8'
CPSPLS12-12108	Column - PVC, Square, Plain Panel /w Single 12" Lattice, 12" @ 9'
CPSPLS12-12120	Column - PVC, Square, Plain Panel /w Single 12" Lattice, 12" @ 10'
CPSPLS12-12144	Column - PVC, Square, Plain Panel /w Single 12" Lattice, 12" @ 12'

\$ 717.53	\$ 674.47
\$ 827.44	\$ 777.80
\$ 907.80	\$ 853.33
\$ 1,098.06	\$ 1,032.17
\$ 1,193.19	\$ 1,121.60
\$ 1,288.33	\$ 1,211.03
\$ 1,478.93	\$ 1,390.20

**\*12% FOR CUSTOM HEIGHT & 12% FOR ACTUAL WIDTH**  
**\*\*\*FOR COLUMNS LARGER THAN 14" PLEASE CONTACT YOUR LOCAL PRESTIGE DEALER**  
**\*\*PRICES SUBJECT TO CHANGE WITHOUT NOTICE**

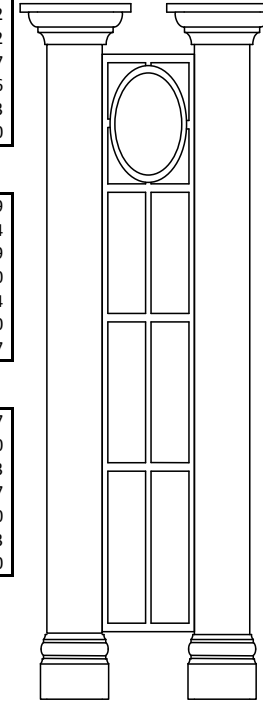

**COCHREN FLARE**

**SQUARING "L" INCLUDED**

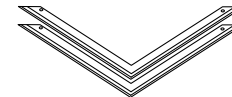

**\*Adds 3" to Outside Dims**

SIZE	OUTSIDE	INSIDE
6"	5-1/2"	4-1/2"
8"	7-1/4"	6-1/4"
10"	9-3/8"	8-3/8"
12"	11-1/2"	10-1/2"
14"	13-1/4"	12-1/4"



**PRESTIGE COLUMNS - 2017**



PRICE LEVEL	
NON-STOCKING	
Standard C&B: 5" CRWN CP & 6" TSCN BSE	
CAP	5" Crown Mould
BASE	PVC Tuscan 6"
<input checked="" type="checkbox"/> ADD CAP & BASE	

**8" COLUMNS**

PRODUCT CODE
CPSPLS16-08048
CPSPLS16-08060
CPSPLS16-08072
CPSPLS16-08096
CPSPLS16-08108
CPSPLS16-08120
CPSPLS16-08144

DESCRIPTION
Column - PVC, Square, Plain Panel /w Single 16" Lattice, 8" @ 4'
Column - PVC, Square, Plain Panel /w Single 16" Lattice, 8" @ 5'
Column - PVC, Square, Plain Panel /w Single 16" Lattice, 8" @ 6'
Column - PVC, Square, Plain Panel /w Single 16" Lattice, 8" @ 8'
Column - PVC, Square, Plain Panel /w Single 16" Lattice, 8" @ 9'
Column - PVC, Square, Plain Panel /w Single 16" Lattice, 8" @ 10'
Column - PVC, Square, Plain Panel /w Single 16" Lattice, 8" @ 12'

	1 PIECE	6 PIECE
\$	634.51	\$ 596.44
\$	737.11	\$ 692.88
\$	800.45	\$ 752.42
\$	966.39	\$ 908.40
\$	1,049.85	\$ 986.86
\$	1,132.34	\$ 1,064.40
\$	1,298.50	\$ 1,220.59

**10" COLUMNS**

CPSPLS16-10048
CPSPLS16-10060
CPSPLS16-10072
CPSPLS16-10096
CPSPLS16-10108
CPSPLS16-10120
CPSPLS16-10144

Column - PVC, Square, Plain Panel /w Single 16" Lattice, 10" @ 4'
Column - PVC, Square, Plain Panel /w Single 16" Lattice, 10" @ 5'
Column - PVC, Square, Plain Panel /w Single 16" Lattice, 10" @ 6'
Column - PVC, Square, Plain Panel /w Single 16" Lattice, 10" @ 8'
Column - PVC, Square, Plain Panel /w Single 16" Lattice, 10" @ 9'
Column - PVC, Square, Plain Panel /w Single 16" Lattice, 10" @ 10'
Column - PVC, Square, Plain Panel /w Single 16" Lattice, 10" @ 12'

\$	688.16	\$ 646.87
\$	801.69	\$ 753.59
\$	875.96	\$ 823.40
\$	1,063.76	\$ 999.93
\$	1,157.66	\$ 1,088.20
\$	1,251.56	\$ 1,176.46
\$	1,439.64	\$ 1,353.26

**12" COLUMNS**

CPSPLS16-12048
CPSPLS16-12060
CPSPLS16-12072
CPSPLS16-12096
CPSPLS16-12108
CPSPLS16-12120
CPSPLS16-12144

Column - PVC, Square, Plain Panel /w Single 16" Lattice, 12" @ 4'
Column - PVC, Square, Plain Panel /w Single 16" Lattice, 12" @ 5'
Column - PVC, Square, Plain Panel /w Single 16" Lattice, 12" @ 6'
Column - PVC, Square, Plain Panel /w Single 16" Lattice, 12" @ 8'
Column - PVC, Square, Plain Panel /w Single 16" Lattice, 12" @ 9'
Column - PVC, Square, Plain Panel /w Single 16" Lattice, 12" @ 10'
Column - PVC, Square, Plain Panel /w Single 16" Lattice, 12" @ 12'

\$	741.77	\$ 697.27
\$	866.22	\$ 814.25
\$	951.42	\$ 894.33
\$	1,161.08	\$ 1,091.41
\$	1,265.91	\$ 1,189.95
\$	1,370.74	\$ 1,288.49
\$	1,580.73	\$ 1,485.89

**\*12% FOR CUSTOM HEIGHT & 12% FOR ACTUAL WIDTH**  
**\*\*\*FOR COLUMNS LARGER THAN 14" PLEASE CONTACT YOUR LOCAL PRESTIGE DEALER**  
**\*\*PRICES SUBJECT TO CHANGE WITHOUT NOTICE**

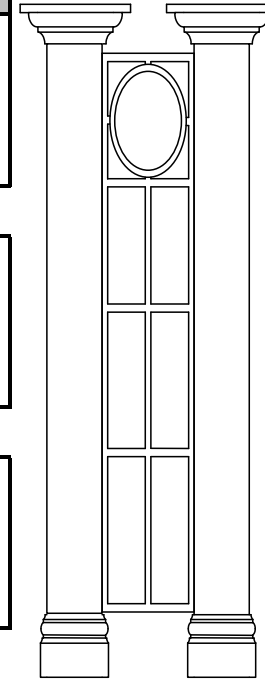

**COCHREN FLARE**

**SQUARING "L" INCLUDED**

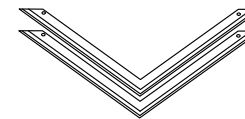

**\*Adds 3" to Outside Dims**

	DIMS	
SIZE	OUTSIDE	INSIDE
6"	5-1/2"	4-1/2"
8"	7-1/4"	6-1/4"
10"	9-3/8"	8-3/8"
12"	11-1/2"	10-1/2"
14"	13-1/4"	12-1/4"



PRICE LEVEL	
NON-STOCKING	
Standard C&B: 5" CRWN CP & 6" TSCN BSE	
CAP	5" Crown Mould
BASE	PVC Tuscan 6"
<input checked="" type="checkbox"/> ADD CAP & BASE	

**PRESTIGE COLUMNS - 2017**

	PRODUCT CODE	DESCRIPTION	1 PIECE	6 PIECE
8" COLUMNS	CPSPLS24-08048	Column - PVC, Square, Plain Panel /w Single 24" Lattice, 8" @ 4'	\$ 683.78	\$ 642.75
	CPSPLS24-08060	Column - PVC, Square, Plain Panel /w Single 24" Lattice, 8" @ 5'	\$ 815.94	\$ 766.98
	CPSPLS24-08072	Column - PVC, Square, Plain Panel /w Single 24" Lattice, 8" @ 6'	\$ 889.14	\$ 835.79
	CPSPLS24-08096	Column - PVC, Square, Plain Panel /w Single 24" Lattice, 8" @ 8'	\$ 1,094.50	\$ 1,028.83
	CPSPLS24-08108	Column - PVC, Square, Plain Panel /w Single 24" Lattice, 8" @ 9'	\$ 1,049.85	\$ 986.86
	CPSPLS24-08120	Column - PVC, Square, Plain Panel /w Single 24" Lattice, 8" @ 10'	\$ 1,299.86	\$ 1,221.87
	CPSPLS24-08144	Column - PVC, Square, Plain Panel /w Single 24" Lattice, 8" @ 12'	\$ 1,505.44	\$ 1,415.12
	10" COLUMNS	CPSPLS24-10048	Column - PVC, Square, Plain Panel /w Single 24" Lattice, 10" @ 4'	\$ 737.43
CPSPLS24-10060		Column - PVC, Square, Plain Panel /w Single 24" Lattice, 10" @ 5'	\$ 880.52	\$ 827.69
CPSPLS24-10072		Column - PVC, Square, Plain Panel /w Single 24" Lattice, 10" @ 6'	\$ 964.65	\$ 906.77
CPSPLS24-10096		Column - PVC, Square, Plain Panel /w Single 24" Lattice, 10" @ 8'	\$ 1,191.86	\$ 1,120.35
CPSPLS24-10108		Column - PVC, Square, Plain Panel /w Single 24" Lattice, 10" @ 9'	\$ 1,305.47	\$ 1,227.15
CPSPLS24-10120		Column - PVC, Square, Plain Panel /w Single 24" Lattice, 10" @ 10'	\$ 1,419.08	\$ 1,333.93
CPSPLS24-10144		Column - PVC, Square, Plain Panel /w Single 24" Lattice, 10" @ 12'	\$ 1,646.58	\$ 1,547.79
12" COLUMNS		CPSPLS24-12048	Column - PVC, Square, Plain Panel /w Single 24" Lattice, 12" @ 4'	\$ 791.03
	CPSPLS24-12060	Column - PVC, Square, Plain Panel /w Single 24" Lattice, 12" @ 5'	\$ 945.06	\$ 888.36
	CPSPLS24-12072	Column - PVC, Square, Plain Panel /w Single 24" Lattice, 12" @ 6'	\$ 1,040.11	\$ 977.71
	CPSPLS24-12096	Column - PVC, Square, Plain Panel /w Single 24" Lattice, 12" @ 8'	\$ 1,289.18	\$ 1,211.83
	CPSPLS24-12108	Column - PVC, Square, Plain Panel /w Single 24" Lattice, 12" @ 9'	\$ 1,413.73	\$ 1,328.90
	CPSPLS24-12120	Column - PVC, Square, Plain Panel /w Single 24" Lattice, 12" @ 10'	\$ 1,538.26	\$ 1,445.96
	CPSPLS24-12144	Column - PVC, Square, Plain Panel /w Single 24" Lattice, 12" @ 12'	\$ 1,787.67	\$ 1,680.41

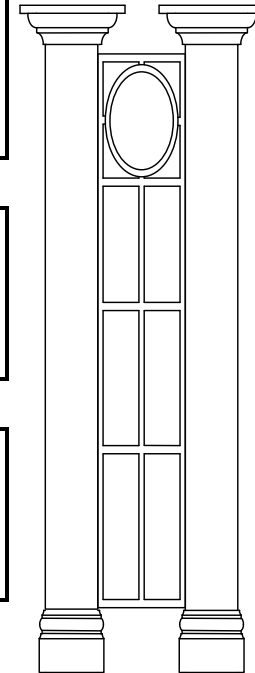

COCHREN FLARE

\*12% FOR CUSTOM HEIGHT & 12% FOR ACTUAL WIDTH  
 \*\*\*FOR COLUMNS LARGER THAN 14" PLEASE CONTACT YOUR LOCAL PRESTIGE DEALER  
 \*\*PRICES SUBJECT TO CHANGE WITHOUT NOTICE

**SQUARING "L" INCLUDED**

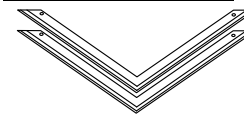

\*Adds 3" to Outside Dims

SIZE	DIMS OUTSIDE	INSIDE
6"	5-1/2"	4-1/2"
8"	7-1/4"	6-1/4"
10"	9-3/8"	8-3/8"
12"	11-1/2"	10-1/2"
14"	13-1/4"	12-1/4"





PRICE LEVEL	
NON-STOCKING	
Standard C&B: 5" CRWN CP & 6" TSCN BSE	
CAP	5" Crown Mould
BASE	PVC Tuscan 6"
<input checked="" type="checkbox"/> ADD CAP & BASE	

**PRESTIGE COLUMNS - 2017**

**8" COLUMNS**

PRODUCT CODE
CPSPLD12-08048
CPSPLD12-08060
CPSPLD12-08072
CPSPLD12-08096
CPSPLD12-08108
CPSPLD12-08120
CPSPLD12-08144

DESCRIPTION
Column - PVC, Square, Plain Panel /w Double 12" Lattice, 8" @ 4'
Column - PVC, Square, Plain Panel /w Double 12" Lattice, 8" @ 5'
Column - PVC, Square, Plain Panel /w Double 12" Lattice, 8" @ 6'
Column - PVC, Square, Plain Panel /w Double 12" Lattice, 8" @ 8'
Column - PVC, Square, Plain Panel /w Double 12" Lattice, 8" @ 9'
Column - PVC, Square, Plain Panel /w Double 12" Lattice, 8" @ 10'
Column - PVC, Square, Plain Panel /w Double 12" Lattice, 8" @ 12'

Innovative PVC Systems	
1 PIECE	6 PIECE
\$ 857.00	\$ 805.58
\$ 1,022.17	\$ 960.84
\$ 1,116.60	\$ 1,049.61
\$ 1,376.22	\$ 1,293.65
\$ 1,506.91	\$ 1,416.50
\$ 1,635.84	\$ 1,537.69
\$ 1,895.75	\$ 1,782.01

**10" COLUMNS**

CPSPLD12-10048
CPSPLD12-10060
CPSPLD12-10072
CPSPLD12-10096
CPSPLD12-10108
CPSPLD12-10120
CPSPLD12-10144

Column - PVC, Square, Plain Panel /w Double 12" Lattice, 10" @ 4'
Column - PVC, Square, Plain Panel /w Double 12" Lattice, 10" @ 5'
Column - PVC, Square, Plain Panel /w Double 12" Lattice, 10" @ 6'
Column - PVC, Square, Plain Panel /w Double 12" Lattice, 10" @ 8'
Column - PVC, Square, Plain Panel /w Double 12" Lattice, 10" @ 9'
Column - PVC, Square, Plain Panel /w Double 12" Lattice, 10" @ 10'
Column - PVC, Square, Plain Panel /w Double 12" Lattice, 10" @ 12'

\$ 926.00	\$ 870.44
\$ 1,105.94	\$ 1,039.59
\$ 1,215.16	\$ 1,142.25
\$ 1,504.31	\$ 1,414.05
\$ 1,648.89	\$ 1,549.95
\$ 1,793.45	\$ 1,685.85
\$ 2,082.99	\$ 1,958.01

**12" COLUMNS**

CPSPLD12-12048
CPSPLD12-12060
CPSPLD12-12072
CPSPLD12-12096
CPSPLD12-12108
CPSPLD12-12120
CPSPLD12-12144

Column - PVC, Square, Plain Panel /w Double 12" Lattice, 12" @ 4'
Column - PVC, Square, Plain Panel /w Double 12" Lattice, 12" @ 5'
Column - PVC, Square, Plain Panel /w Double 12" Lattice, 12" @ 6'
Column - PVC, Square, Plain Panel /w Double 12" Lattice, 12" @ 8'
Column - PVC, Square, Plain Panel /w Double 12" Lattice, 12" @ 9'
Column - PVC, Square, Plain Panel /w Double 12" Lattice, 12" @ 10'
Column - PVC, Square, Plain Panel /w Double 12" Lattice, 12" @ 12'

\$ 994.97	\$ 935.27
\$ 1,189.68	\$ 1,118.30
\$ 1,313.66	\$ 1,234.84
\$ 1,632.34	\$ 1,534.40
\$ 1,791.69	\$ 1,684.19
\$ 1,951.03	\$ 1,833.97
\$ 2,270.17	\$ 2,133.96

**\*12% FOR CUSTOM HEIGHT & 12% FOR ACTUAL WIDTH**  
**\*\*\*FOR COLUMNS LARGER THAN 14" PLEASE CONTACT YOUR LOCAL PRESTIGE DEALER**  
**\*\*PRICES SUBJECT TO CHANGE WITHOUT NOTICE**

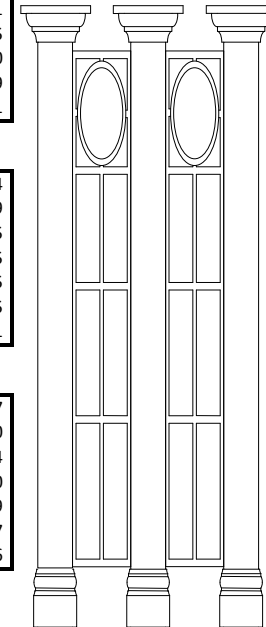

**COCHREN FLARE**

**SQUARING "L" INCLUDED**

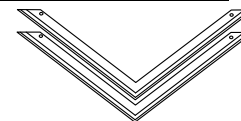

**\*Adds 3" to Outside Dims**

SIZE	DIMS	
	OUTSIDE	INSIDE
6"	5-1/2"	4-1/2"
8"	7-1/4"	6-1/4"
10"	9-3/8"	8-3/8"
12"	11-1/2"	10-1/2"
14"	13-1/4"	12-1/4"



PRICE LEVEL	
NON-STOCKING	
Standard C&B: 5" CRWN CP & 6" TSCN BSE	
CAP	5" Crown Mould
BASE	PVC Tuscan 6"
<input checked="" type="checkbox"/> ADD CAP & BASE	

**PRESTIGE COLUMNS - 2017**

8" COLUMNS	PRODUCT CODE	DESCRIPTION
	CPSPLD16-08048	Column - PVC, Square, Plain Panel /w Double 16" Lattice, 8" @ 4'
	CPSPLD16-08060	Column - PVC, Square, Plain Panel /w Double 16" Lattice, 8" @ 5'
	CPSPLD16-08072	Column - PVC, Square, Plain Panel /w Double 16" Lattice, 8" @ 6'
	CPSPLD16-08096	Column - PVC, Square, Plain Panel /w Double 16" Lattice, 8" @ 8'
	CPSPLD16-08108	Column - PVC, Square, Plain Panel /w Double 16" Lattice, 8" @ 9'
	CPSPLD16-08120	Column - PVC, Square, Plain Panel /w Double 16" Lattice, 8" @ 10'
	CPSPLD16-08144	Column - PVC, Square, Plain Panel /w Double 16" Lattice, 8" @ 12'

1 PIECE	6 PIECE
\$ 857.00	\$ 805.58
\$ 1,022.17	\$ 960.84
\$ 1,116.60	\$ 1,049.61
\$ 1,376.22	\$ 1,293.65
\$ 1,506.91	\$ 1,416.50
\$ 1,635.84	\$ 1,537.69
\$ 1,895.75	\$ 1,782.01

10" COLUMNS	PRODUCT CODE	DESCRIPTION
	CPSPLD16-10048	Column - PVC, Square, Plain Panel /w Double 16" Lattice, 10" @ 4'
	CPSPLD16-10060	Column - PVC, Square, Plain Panel /w Double 16" Lattice, 10" @ 5'
	CPSPLD16-10072	Column - PVC, Square, Plain Panel /w Double 16" Lattice, 10" @ 6'
	CPSPLD16-10096	Column - PVC, Square, Plain Panel /w Double 16" Lattice, 10" @ 8'
	CPSPLD16-10108	Column - PVC, Square, Plain Panel /w Double 16" Lattice, 10" @ 9'
	CPSPLD16-10120	Column - PVC, Square, Plain Panel /w Double 16" Lattice, 10" @ 10'
	CPSPLD16-10144	Column - PVC, Square, Plain Panel /w Double 16" Lattice, 10" @ 12'

\$ 926.00	\$ 870.44
\$ 1,105.94	\$ 1,039.59
\$ 1,215.16	\$ 1,142.25
\$ 1,504.31	\$ 1,414.05
\$ 1,648.89	\$ 1,549.95
\$ 1,793.45	\$ 1,685.85
\$ 2,082.99	\$ 1,958.01

12" COLUMNS	PRODUCT CODE	DESCRIPTION
	CPSPLD16-12048	Column - PVC, Square, Plain Panel /w Double 16" Lattice, 12" @ 4'
	CPSPLD16-12060	Column - PVC, Square, Plain Panel /w Double 16" Lattice, 12" @ 5'
	CPSPLD16-12072	Column - PVC, Square, Plain Panel /w Double 16" Lattice, 12" @ 6'
	CPSPLD16-12096	Column - PVC, Square, Plain Panel /w Double 16" Lattice, 12" @ 8'
	CPSPLD16-12108	Column - PVC, Square, Plain Panel /w Double 16" Lattice, 12" @ 9'
	CPSPLD16-12120	Column - PVC, Square, Plain Panel /w Double 16" Lattice, 12" @ 10'
	CPSPLD16-12144	Column - PVC, Square, Plain Panel /w Double 16" Lattice, 12" @ 12'

\$ 994.97	\$ 935.27
\$ 1,189.68	\$ 1,118.30
\$ 1,313.66	\$ 1,234.84
\$ 1,632.34	\$ 1,534.40
\$ 1,791.69	\$ 1,684.19
\$ 1,951.03	\$ 1,833.97
\$ 2,270.17	\$ 2,133.96

\*12% FOR CUSTOM HEIGHT & 12% FOR ACTUAL WIDTH

\*\*\*FOR COLUMNS LARGER THAN 14" PLEASE CONTACT YOUR LOCAL PRESTIGE DEALER

\*\*PRICES SUBJECT TO CHANGE WITHOUT NOTICE

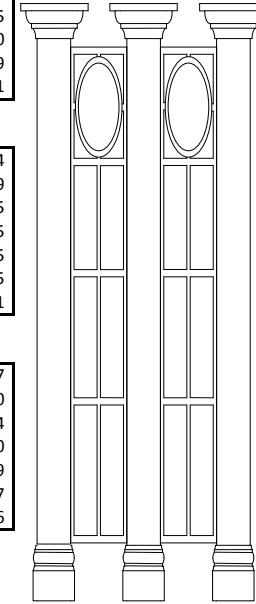

**COCHRAN FLARE**

**SQUARING "L" INCLUDED**

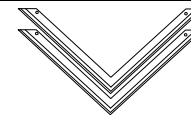

\*Adds 3" to Outside Dims

SIZE	DIMS OUTSIDE	INSIDE
6"	5-1/2"	4-1/2"
8"	7-1/4"	6-1/4"
10"	9-3/8"	8-3/8"
12"	11-1/2"	10-1/2"
14"	13-1/4"	12-1/4"



PRICE LEVEL	
NON-STOCKING	
Standard C&B: 5" CRWN CP & 6" TSCN BSE	
CAP	5" Crown Mould
BASE	PVC Tuscan 6"
<input checked="" type="checkbox"/> ADD CAP & BASE	

**PRESTIGE COLUMNS - 2017**

**8" COLUMNS**

PRODUCT CODE
CPSPLD24-08048
CPSPLD24-08060
CPSPLD24-08072
CPSPLD24-08096
CPSPLD24-08108
CPSPLD24-08120
CPSPLD24-08144

DESCRIPTION
Column - PVC, Square, Plain Panel /w Double 24" Lattice, 8" @ 4'
Column - PVC, Square, Plain Panel /w Double 24" Lattice, 8" @ 5'
Column - PVC, Square, Plain Panel /w Double 24" Lattice, 8" @ 6'
Column - PVC, Square, Plain Panel /w Double 24" Lattice, 8" @ 8'
Column - PVC, Square, Plain Panel /w Double 24" Lattice, 8" @ 9'
Column - PVC, Square, Plain Panel /w Double 24" Lattice, 8" @ 10'
Column - PVC, Square, Plain Panel /w Double 24" Lattice, 8" @ 12'

1 PIECE	6 PIECE
\$ 945.77	\$ 889.03
\$ 1,164.21	\$ 1,094.36
\$ 1,276.41	\$ 1,199.82
\$ 1,607.04	\$ 1,510.62
\$ 1,506.91	\$ 1,416.50
\$ 1,937.68	\$ 1,821.41
\$ 2,268.62	\$ 2,132.50

**10" COLUMNS**

CPSPLD24-10048
CPSPLD24-10060
CPSPLD24-10072
CPSPLD24-10096
CPSPLD24-10108
CPSPLD24-10120
CPSPLD24-10144

Column - PVC, Square, Plain Panel /w Double 24" Lattice, 10" @ 4'
Column - PVC, Square, Plain Panel /w Double 24" Lattice, 10" @ 5'
Column - PVC, Square, Plain Panel /w Double 24" Lattice, 10" @ 6'
Column - PVC, Square, Plain Panel /w Double 24" Lattice, 10" @ 8'
Column - PVC, Square, Plain Panel /w Double 24" Lattice, 10" @ 9'
Column - PVC, Square, Plain Panel /w Double 24" Lattice, 10" @ 10'
Column - PVC, Square, Plain Panel /w Double 24" Lattice, 10" @ 12'

\$ 1,014.78	\$ 953.89
\$ 1,247.99	\$ 1,173.11
\$ 1,374.96	\$ 1,292.46
\$ 1,735.13	\$ 1,631.02
\$ 1,915.21	\$ 1,800.30
\$ 2,095.30	\$ 1,969.58
\$ 2,455.85	\$ 2,308.50

**12" COLUMNS**

CPSPLD24-12048
CPSPLD24-12060
CPSPLD24-12072
CPSPLD24-12096
CPSPLD24-12108
CPSPLD24-12120
CPSPLD24-12144

Column - PVC, Square, Plain Panel /w Double 24" Lattice, 12" @ 4'
Column - PVC, Square, Plain Panel /w Double 24" Lattice, 12" @ 5'
Column - PVC, Square, Plain Panel /w Double 24" Lattice, 12" @ 6'
Column - PVC, Square, Plain Panel /w Double 24" Lattice, 12" @ 8'
Column - PVC, Square, Plain Panel /w Double 24" Lattice, 12" @ 9'
Column - PVC, Square, Plain Panel /w Double 24" Lattice, 12" @ 10'
Column - PVC, Square, Plain Panel /w Double 24" Lattice, 12" @ 12'

\$ 1,083.75	\$ 1,018.72
\$ 1,331.73	\$ 1,251.82
\$ 1,473.45	\$ 1,385.05
\$ 1,863.16	\$ 1,751.37
\$ 2,058.02	\$ 1,934.54
\$ 2,252.88	\$ 2,117.70
\$ 2,643.04	\$ 2,484.45

\*12% FOR CUSTOM HEIGHT & 12% FOR ACTUAL WIDTH

\*\*\*FOR COLUMNS LARGER THAN 14" PLEASE CONTACT YOUR LOCAL PRESTIGE DEALER

\*\*PRICES SUBJECT TO CHANGE WITHOUT NOTICE

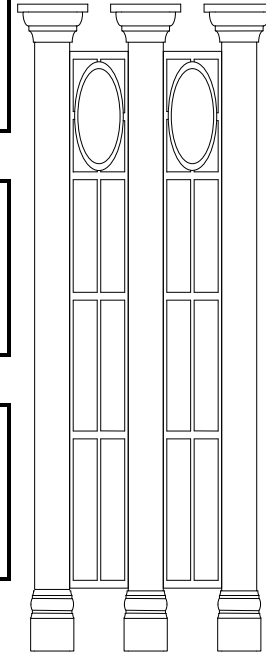

**COCHREN FLARE**

**SQUARING "L" INCLUDED**



\*Adds 3" to Outside Dims

SIZE	DIMS	
	OUTSIDE	INSIDE
6"	5-1/2"	4-1/2"
8"	7-1/4"	6-1/4"
10"	9-3/8"	8-3/8"
12"	11-1/2"	10-1/2"
14"	13-1/4"	12-1/4"

P  
R  
E  
S  
T  
I  
G  
E  
  
N  
E  
W  
E  
L  
  
P  
O  
S  
T  
S

H E I G H T	W I D T H				
	6	8	10	12	14
22	\$58.58	\$78.10	\$97.63	\$117.16	\$136.69
24	\$63.91	\$85.21	\$106.51	\$127.81	\$149.11
26	\$69.23	\$92.30	\$115.38	\$138.46	\$161.54
28	\$74.55	\$99.41	\$124.26	\$149.11	\$173.97
30	\$79.88	\$106.51	\$133.13	\$159.76	\$186.38
32	\$85.21	\$113.60	\$142.01	\$170.42	\$198.81
34	\$90.53	\$120.71	\$150.88	\$181.06	\$211.24
36	\$95.85	\$127.81	\$159.76	\$191.72	\$223.66
38	\$101.19	\$134.91	\$168.63	\$202.36	\$236.09
40	\$106.51	\$142.01	\$177.51	\$213.02	\$248.52
42	\$111.83	\$149.11	\$186.38	\$223.66	\$260.95
44	\$117.16	\$156.21	\$195.26	\$234.32	\$273.37
46	\$122.49	\$163.31	\$204.14	\$244.97	\$285.80
48	\$127.81	\$170.42	\$213.02	\$255.62	\$298.22

NEWEL OPTIONS		SELECT	SELECTED OPTIONS
FLUTED - 25% Upcharge	(FL)	<input type="checkbox"/>	
RAISED PANEL - 20% Upcharge	(RA)	<input type="checkbox"/>	
RECESSED PANEL - 35% Upcharge	(RS)	<input type="checkbox"/>	
RECESSED FLUSH TRIM - 45% Upcharge	(RBF)	<input type="checkbox"/>	
STANDARD FLAT LID (FC)		<input type="checkbox"/>	
	6" - 10" LID - 15% Upcharge	<input type="checkbox"/>	
	12" - 14" LID - 20% Upcharge	<input type="checkbox"/>	
CHAMFERED LID (CC)		<input type="checkbox"/>	
	6" - 10" LID - 25% Upcharge	<input type="checkbox"/>	
	12" - 14" LID - 35% Upcharge	<input type="checkbox"/>	
PRICING INSTRUCTIONS			\$ -
PRICE	ENTER PRICE INTO BLUE CELL		



PRESTIGE NEWEL POST STYLES:

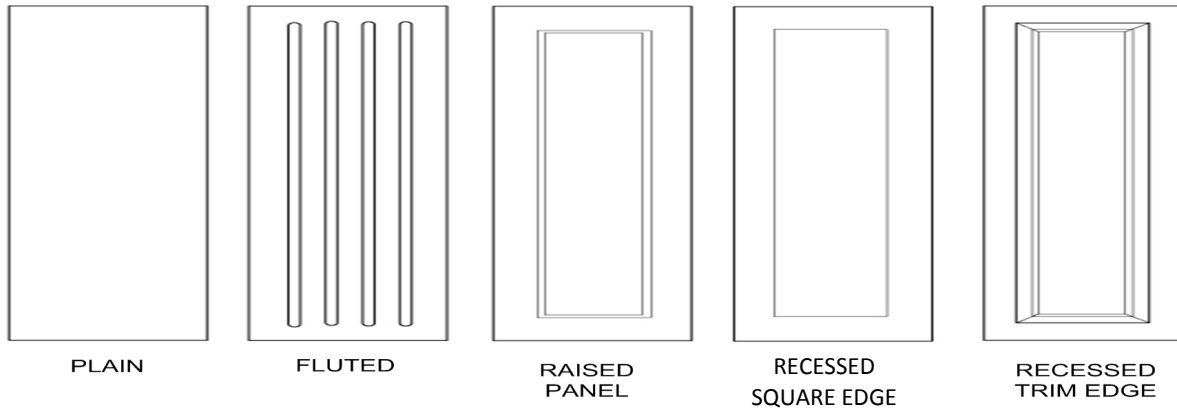

\*\*PRICES SUBJECT TO CHANGE WITHOUT NOTICE

**PRESTIGE PLINTH BOXES - 2017**

PRESTIGE PLINTH BOXES

HEIGHT	WIDTH					
	16	18	20	22	24	26
22	\$138.22	\$155.50	\$172.77	\$190.05	\$207.32	\$224.60
24	\$150.79	\$169.63	\$188.47	\$207.32	\$226.17	\$245.02
26	\$163.34	\$183.77	\$204.19	\$224.60	\$245.02	\$265.44
28	\$175.91	\$197.90	\$219.89	\$241.88	\$263.86	\$285.86
30	\$188.47	\$212.03	\$235.59	\$259.15	\$282.71	\$306.27
32	\$201.04	\$226.17	\$251.31	\$276.43	\$301.56	\$326.69
34	\$213.61	\$240.30	\$267.01	\$293.71	\$320.41	\$347.11
36	\$226.17	\$254.44	\$282.71	\$310.99	\$339.26	\$367.53
38	\$238.74	\$268.58	\$298.43	\$328.27	\$358.11	\$387.95
40	\$251.31	\$282.71	\$314.13	\$345.54	\$376.95	\$408.37
42	\$263.86	\$296.85	\$329.83	\$362.82	\$395.80	\$428.79
44	\$276.43	\$310.99	\$345.54	\$380.10	\$414.65	\$449.20
46	\$289.00	\$325.12	\$361.25	\$397.37	\$433.50	\$469.62
48	\$301.56	\$339.26	\$376.95	\$414.65	\$452.35	\$490.04

PLINTH OPTIONS		SELECT	SELECTED OPTIONS
FLUTED - 25% Upcharge	(FL)	<input type="checkbox"/>	
RAISED PANEL - 20% Upcharge	(RA)	<input type="checkbox"/>	
RECESSED PANEL - 35% Upcharge	(RS)	<input type="checkbox"/>	
RECESSED FLUSH TRIM - 45% Upcharge	(RBF)	<input type="checkbox"/>	
STANDARD FLAT LID (FC)		<input type="checkbox"/>	
	6" - 10" LID - 15% Upcharge	<input type="checkbox"/>	
	12" - 14" LID - 20% Upcharge	<input type="checkbox"/>	
CHAMFERED LID (CC)		<input type="checkbox"/>	
	6" - 10" LID - 25% Upcharge	<input type="checkbox"/>	
	12" - 14" LID - 35% Upcharge	<input type="checkbox"/>	
PRICING INSTRUCTIONS			\$ -
PRICE	ENTER PRICE INTO BLUE CELL		

**PRESTIGE PLINTH BOX STYLES:**



PLAIN

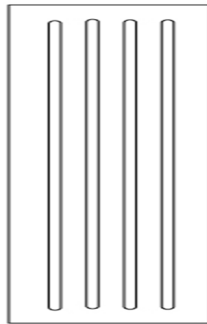

FLUTED

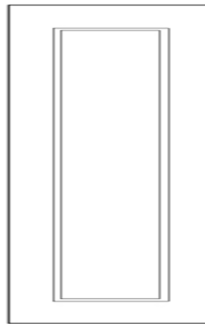

RAISED  
PANEL

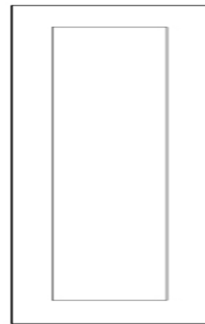

RECESSED  
SQUARE EDGE



RECESSED  
TRIM EDGE

**\*\*PRICES SUBJECT TO CHANGE WITHOUT NOTICE**





**PRESTIGE SOFFIT - 2017**



PRESTIGE SOFFIT



	PRODUCT CODE	DESCRIPTION	NATURAL FINISH		PRE-FINISHED		STAINED	
			PER PIECE PRICE	PER BOX PRICE	PER PIECE PRICE	PER BOX PRICE	PER PIECE PRICE	PER BOX PRICE
SOLID SOFFIT	<b>*SOLD IN BOXES OF 6PCS</b>							
	PSFS1212-48	Soffit - PVC, Solid - 1/2" x 12" x 48" /w Easy Fit System	\$ 38.06	\$ 228.35	\$ 49.47	\$ 296.85	\$ 71.74	\$ 430.44
	PSFS1216-48	Soffit - PVC, Solid - 1/2" x 16" x 48" /w Easy Fit System	\$ 49.25	\$ 295.51	\$ 64.03	\$ 384.16	\$ 92.84	\$ 557.04
	PSFS1224-48	Soffit - PVC, Solid - 1/2" x 24" x 48" /w Easy Fit System	\$ 73.88	\$ 443.27	\$ 96.04	\$ 576.25	\$ 139.25	\$ 835.56
VENTED SOFFIT	<b>*SOLD IN BOXES OF 6PCS</b>							
	PSFV1212-48	Soffit - PVC, Vented - 1/2" x 12" x 48" /w Easy Fit System	\$ 50.37	\$ 302.23	\$ 65.48	\$ 392.90	\$ 94.94	\$ 569.70
	PSFV1216-48	Soffit - PVC, Vented - 1/2" x 16" x 48" /w Easy Fit System	\$ 67.16	\$ 402.97	\$ 87.31	\$ 523.86	\$ 126.60	\$ 759.60
	PSFV1224-48	Soffit - PVC, Vented - 1/2" x 24" x 48" /w Easy Fit System	\$ 100.74	\$ 604.45	\$ 130.97	\$ 785.79	\$ 189.90	\$ 1,139.39
SOFFIT KITS	<b>*SOLD IN BOXES OF 8PCS</b>							
	PSFS1212-K5C	Soffit - PVC - Kit - 5pcs Vented Soffit 1/2" x 12" x 48", 2pcs Corner Panel & 1pc 4' Spline		\$ 349.81		\$ 450.16		\$ 650.12
	PSFS1216-K5C	Soffit - PVC - Kit - 5pcs Vented Soffit 1/2" x 16" x 48", 2pcs Corner Panel & 1pc 4' Spline		\$ 458.62		\$ 575.11		\$ 853.69
	PSFS1224-K5C	Soffit - PVC - Kit - 5pcs Vented Soffit 1/2" x 24" x 48", 2pcs Corner Panel & 1pc 4' Spline		\$ 651.09		\$ 884.33		\$ 1,267.55
TRANSITION CORNERS	PSFC1212-12	Soffit - PVC, Solid - 1/2" x 12" x 12" /w Easy Fit System	\$ 13.43		\$ 17.47		\$ 22.70	
	PSFC1216-16	Soffit - PVC, Solid - 1/2" x 16" x 16" /w Easy Fit System	\$ 16.79		\$ 21.83		\$ 28.37	
	PSFC1224-16	Soffit - PVC, Solid - 1/2" x 24" x 16" /w Easy Fit System	\$ 25.19		\$ 32.75		\$ 42.57	
INSERT MOULD	PSTM-48	Soffit - PVC, "Spline" 1/4" x 2" x 48"	\$ 12.80		\$ 16.64		\$ 21.64	

**\*\*PRICES SUBJECT TO CHANGE WITHOUT NOTICE**

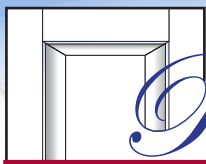

# Prestige SHUTTERS

Innovative PVC Systems



*Shutters shown above:  
Distinctive Collection, Raised Panel*



## The Prestige Advantage

### Beautiful

- Classic Architectural Look
- No Visible Fasteners
- Wide Assortment of Styles

### Easy Installation

- Complete Kit, with Fasteners & Adhesive
- No Special Tools Needed
- Flat-Pack for Safe & Easy Transportation

### Virtually Maintenance Free

- Free-Foam Cellular PVC Construction
- Weather, Decay and Insect Resistant
- Paint Friendly with Acrylic Latex Paints

**Prestige Shutters are available in two style categories to best accommodate our customers needs.**

The **DECOR COLLECTION**, at a lower cost, shows a beautiful traditional profile but is manufactured using a single PVC sheet with the profile engraved directly to the surface.

The **DISTINCTIVE COLLECTION** is made with true traditional rail and stile construction creating a strong, durable shutter to enjoy for years to come.

All **shutters** are custom ordered to suit your project.

## DECOR COLLECTION

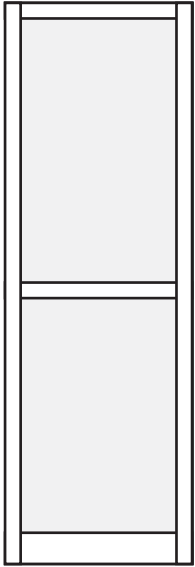

Recessed Flat Panel

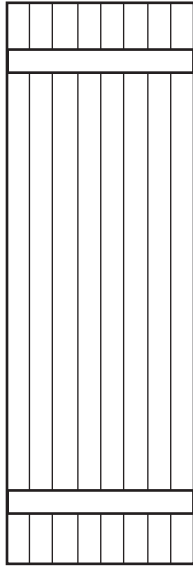

Board & Batten

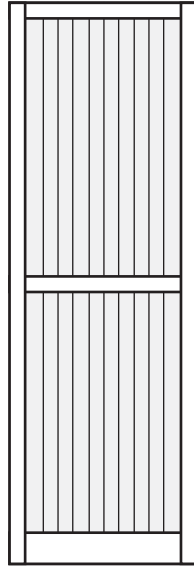

Recessed V-Groove Panel

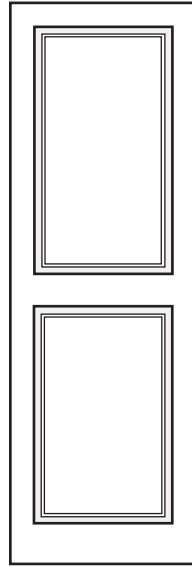

Raised Panel (Routed)



### Standard Measurements for Decor Collection & Distinctive Collections.

Thickness:	1"
Vertical Stile Width:	2 1/2"
Top Rail Height:	2 1/2"
Middle Rail Height:	2 1/2"
Bottom Rail Height:	4 1/2"

## DISTINCTIVE COLLECTION

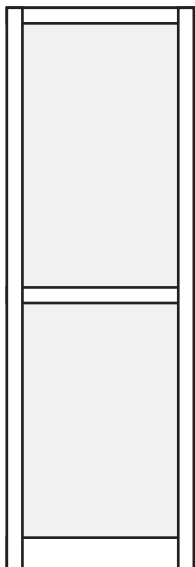

Recessed Flat Panel

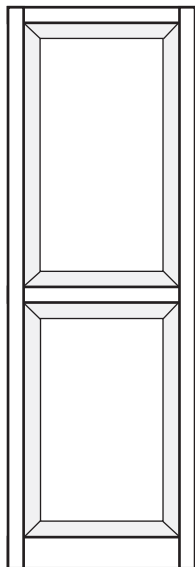

Raised Panel

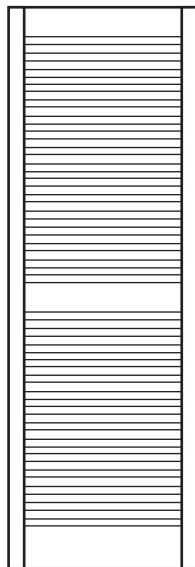

Louvre-Closed



Decor Collection - Raised Panel

Distinctive Collection - Raised Panel

Distinctive Collection - Closed Louvre

PRESTIGE PVC SHUTTER POLICIES

- 1 **Once an order has been placed , it is non-cancelable and non-returnable.**
- 2 **Only complete orders will be accepted.**
  - Partial orders that are missing key information such as: colour, size, ship to location, etc. Will not be accepted
  - Changes Will not be accepted once original order has been allocated for manufacturing
  - Changes Will be accepted prior to allocation. The original order Will be cancelled and The Changes Will be entered as a new order with a new ship date
- 3 **Decor/Distinctive Collections are designed with "key hole" hanging system and come with fasteners for HANGING**  
(NO FACE DAMAGE NESSACCARY BY USE OF SCREWS THROUGH FINISHED FACE)  
  
**Prices do not include Hardware (see collection tabs to add hardware)**  
**- for hardware options and pricing please see The hardware tab**
  - Shutters from 12" to 48" in height require the use of 2 Hinges
  - Shutters from 49" to 96" in height require the use of 3 Hinges
  - Shutters from 97" to 144" in height require the use of 4 Hinges
  - Shutters over 144" in height require the use of 5 Hinges
- 4 **Prices do not include freight. All products are F.O.B Oakville, Ontario**
  - Additional charges may apply for shipments outside of Canada, to residential addresses/locations or construction sites
  - Additional charges may apply for special requests on shipping, packaging & delivery
- 5 Prices reflect the price per pair
- 6 Pricing for a single shutter will half the price of a shutter pair, Design options will receive the entire per pair price
- 7 Pricing is based on 6 standard colours
  - a one time \$150 fee will assessed for all custom colour requests with a minimum of 1 Gallon
  - a primed finish option is available on all Shutters
- 8 Shutter heights and widths are available in 1/8" increments
- 9 Heights at less than 30" are priced at a 30" minimum
- 10 **All product needs to be inspected immediately upon receipt of delivery**  
Freight damage claims received after 12 days of receipt of delivery will result in No Credit
- 11 Shutter sizes exceeding 90" in length or width will have an additional freight charge please contact your sales rep for quotation
- 12 Special shipping crate may be required for oversize shipments and/or any orders shipped outside of Ontario.  
An additional freight charge please contact your sales rep for quotation

SHUTTER HARDWARE - 2017



Innovative PVC Systems

S  
H  
U  
T  
T  
E  
R  
  
H  
A  
R  
D  
W  
A  
R  
E

DESCRIPTION

PRICE      INNOVATIVE PVC SYSTEMS  
NEEDED      TOTAL

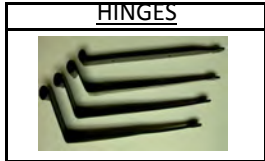

- 12" Hinge Arm
- Sold in pairs, 2 pairs per window
- Offsets available: 0", 1", 2" & 3"
- Sold in pairs
- Stainless Steel

\$ 84.24	0	\$ -
----------	---	------



- Sets of 4 Hinges /w 4 Pintels
- 6 3/4"w x 5"h
- Strengthens corners of the shutter
- Offsets available: 0", 1 1/2" & 2 1/8"
- Cast Iron construction /w rust resistant paint

\$ 302.64	0	\$ -
-----------	---	------

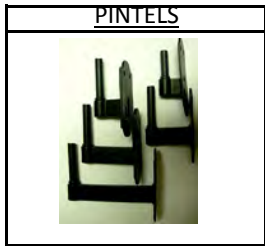

- Sold in pairs (2 pairs per window)
- Offsets available: 1/2", 1 1/2" & 2 1/4"
- Stainless Steel

\$ 99.84	0	\$ -
----------	---	------



- 7" Tall with 4" Lag
- Sold in pairs
- Stainless Steel

\$ 127.92	0	\$ -
-----------	---	------

SELECTION TOTAL	\$	-
-----------------	----	---

\*\*PRICES SUBJECT TO CHANGE WITHOUT NOTICE





DECOR COLLECTION SHUTTERS - 2017



RAISED PANEL

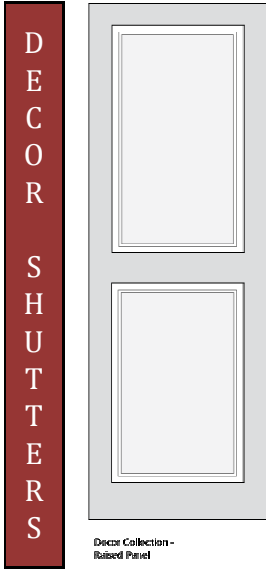

HEIGHT	WIDTH										
	12	14	16	18	20	22	24	26	28	30	32
24	\$ 112.61	\$ 131.38	\$ 150.14	\$ 168.92	\$ 187.68	\$ 206.45	\$ 225.21	\$ 243.99	\$ 262.75	\$ 281.52	\$ 300.28
30	\$ 140.76	\$ 164.22	\$ 187.68	\$ 211.14	\$ 234.60	\$ 258.07	\$ 281.52	\$ 304.98	\$ 328.44	\$ 351.90	\$ 375.37
36	\$ 168.92	\$ 197.06	\$ 225.21	\$ 253.37	\$ 281.52	\$ 309.67	\$ 337.82	\$ 365.98	\$ 394.13	\$ 422.28	\$ 450.44
42	\$ 197.06	\$ 229.91	\$ 262.75	\$ 295.60	\$ 328.44	\$ 361.29	\$ 394.13	\$ 426.97	\$ 459.81	\$ 492.67	\$ 525.51
48	\$ 225.21	\$ 262.75	\$ 300.28	\$ 337.82	\$ 375.37	\$ 412.90	\$ 450.44	\$ 487.97	\$ 525.51	\$ 563.04	\$ 600.58
54	\$ 253.37	\$ 295.60	\$ 337.82	\$ 380.05	\$ 422.28	\$ 464.51	\$ 506.74	\$ 548.96	\$ 591.19	\$ 633.42	\$ 675.65
60	\$ 281.52	\$ 328.44	\$ 375.37	\$ 422.28	\$ 469.20	\$ 516.12	\$ 563.04	\$ 609.97	\$ 656.88	\$ 703.80	\$ 750.72
66	\$ 309.67	\$ 361.29	\$ 412.90	\$ 464.51	\$ 516.12	\$ 567.74	\$ 619.34	\$ 670.96	\$ 722.57	\$ 774.19	\$ 825.79
72	\$ 337.82	\$ 394.13	\$ 450.44	\$ 506.74	\$ 563.04	\$ 619.34	\$ 675.65	\$ 731.96	\$ 788.26	\$ 844.57	\$ 900.86
78	\$ 365.98	\$ 426.97	\$ 487.97	\$ 548.96	\$ 609.97	\$ 670.96	\$ 731.96	\$ 792.95	\$ 853.94	\$ 914.94	\$ 975.94
84	\$ 394.13	\$ 459.81	\$ 525.51	\$ 591.19	\$ 656.88	\$ 722.57	\$ 788.26	\$ 853.94	\$ 919.64	\$ 985.32	\$ 1,051.02
90	\$ 422.28	\$ 492.67	\$ 563.04	\$ 633.42	\$ 703.80	\$ 774.19	\$ 844.57	\$ 914.94	\$ 985.32	\$ 1,055.70	\$ 1,126.09
96	\$ 450.44	\$ 525.51	\$ 600.58	\$ 675.65	\$ 750.72	\$ 825.79	\$ 900.86	\$ 975.94	\$ 1,051.02	\$ 1,126.09	\$ 1,201.16
102	\$ 478.59	\$ 558.35	\$ 638.12	\$ 717.88	\$ 797.64	\$ 877.41	\$ 957.17	\$ 1,036.94	\$ 1,116.70	\$ 1,196.47	\$ 1,276.23
108	\$ 506.74	\$ 591.19	\$ 675.65	\$ 760.11	\$ 844.57	\$ 929.02	\$ 1,013.47	\$ 1,097.93	\$ 1,182.39	\$ 1,266.84	\$ 1,351.30
114	\$ 534.89	\$ 624.04	\$ 713.19	\$ 802.34	\$ 891.49	\$ 980.63	\$ 1,069.78	\$ 1,158.93	\$ 1,248.08	\$ 1,337.22	\$ 1,426.37
120	\$ 563.04	\$ 656.88	\$ 750.72	\$ 844.57	\$ 938.40	\$ 1,032.24	\$ 1,126.09	\$ 1,219.92	\$ 1,313.77	\$ 1,407.61	\$ 1,501.44

\*\*PRICES SUBJECT TO CHANGE WITHOUT NOTICE

SHUTTER OPTIONS		SELECT	SELECTED OPTIONS
FRAMES	SINGLE PANEL - 5% Upcharge	<input type="checkbox"/>	
	TRIPLE PANEL - 10% Upcharge	<input type="checkbox"/>	
	CUSTOM RAIL - 15% Upcharge	<input type="checkbox"/>	
	CUSTOM SHUTTER DETAIL - 25% Upcharge	<input type="checkbox"/>	
	ARCHED TOP - 25% Upcharge	<input type="checkbox"/>	
PRICING INSTRUCTIONS			\$ -
ENTER PRICE INTO BLUE CELL			
HANGING OPTIONS:	FLUSH MOUNT (WOOD/SIDING) INCLUDED	<input type="checkbox"/>	
	FACE MOUNT (CONCRETE/BRICK)	<input type="checkbox"/>	
	HINGES (SEE HARDWARE PAGE)	<input type="checkbox"/>	
<a href="#">HARDWARE PAGE LINK</a>			
TOTAL			\$ -

\*Sold in Pairs  
 \*\*Prices reflect double panel shutters with even sized panels.  
 \*Prices subject to change without notice

PRICE LEVEL
NON-STOCKING



**DECOR COLLECTION SHUTTERS - 2017**



**RECESSED PANEL**

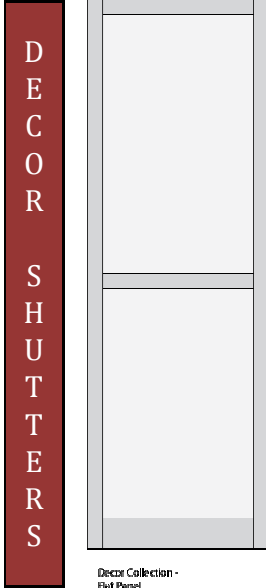

		WIDTH										
		12	14	16	18	20	22	24	26	28	30	32
HEIGHT	24	\$120.42	\$140.48	\$160.55	\$180.62	\$200.69	\$220.76	\$240.83	\$260.90	\$280.97	\$301.03	\$321.11
	30	\$150.52	\$175.60	\$200.69	\$225.77	\$250.86	\$275.95	\$301.03	\$326.12	\$351.20	\$376.30	\$401.39
	36	\$180.62	\$210.72	\$240.83	\$270.93	\$301.03	\$331.14	\$361.25	\$391.34	\$421.45	\$451.56	\$481.66
	42	\$210.72	\$245.85	\$280.97	\$316.09	\$351.20	\$386.33	\$421.45	\$456.57	\$491.69	\$526.82	\$561.93
	48	\$240.83	\$280.97	\$321.11	\$361.25	\$401.39	\$441.52	\$481.66	\$521.79	\$561.93	\$602.07	\$642.21
	54	\$270.93	\$316.09	\$361.25	\$406.40	\$451.56	\$496.71	\$541.87	\$587.02	\$632.17	\$677.33	\$722.48
	60	\$301.03	\$351.20	\$401.39	\$451.56	\$501.73	\$551.90	\$602.07	\$652.25	\$702.42	\$752.59	\$802.76
	66	\$331.14	\$386.33	\$441.52	\$496.71	\$551.90	\$607.09	\$662.28	\$717.47	\$772.65	\$827.85	\$883.04
	72	\$361.25	\$421.45	\$481.66	\$541.87	\$602.07	\$662.28	\$722.48	\$782.70	\$842.90	\$903.11	\$963.31
	78	\$391.34	\$456.57	\$521.79	\$587.02	\$652.25	\$717.47	\$782.70	\$847.92	\$913.14	\$978.36	\$1,043.59
	84	\$421.45	\$491.69	\$561.93	\$632.17	\$702.42	\$772.65	\$842.90	\$913.14	\$983.39	\$1,053.62	\$1,123.87
	90	\$451.56	\$526.82	\$602.07	\$677.33	\$752.59	\$827.85	\$903.11	\$978.36	\$1,053.62	\$1,128.89	\$1,204.15
	96	\$481.66	\$561.93	\$642.21	\$722.48	\$802.76	\$883.04	\$963.31	\$1,043.59	\$1,123.87	\$1,204.15	\$1,284.42
	102	\$511.76	\$597.05	\$682.34	\$767.64	\$852.93	\$938.22	\$1,023.52	\$1,108.82	\$1,194.11	\$1,279.41	\$1,364.70
108	\$541.87	\$632.17	\$722.48	\$812.79	\$903.11	\$993.42	\$1,083.73	\$1,174.04	\$1,264.35	\$1,354.66	\$1,444.98	
114	\$571.97	\$667.30	\$762.62	\$857.96	\$953.28	\$1,048.61	\$1,143.93	\$1,239.27	\$1,334.59	\$1,429.92	\$1,525.24	
120	\$602.07	\$702.42	\$802.76	\$903.11	\$1,003.45	\$1,103.79	\$1,204.15	\$1,304.49	\$1,404.84	\$1,505.18	\$1,605.52	

**\*\*PRICES SUBJECT TO CHANGE WITHOUT NOTICE**

SHUTTER OPTIONS		SELECT	SELECTED OPTIONS
FRAMES	SINGLE PANEL - 5% Upcharge	<input type="checkbox"/>	
	TRIPLE PANEL - 10% Upcharge	<input type="checkbox"/>	
	CUSTOM RAIL - 15% Upcharge	<input type="checkbox"/>	
	CUSTOM SHUTTER DETAIL - 25% Upcharge	<input type="checkbox"/>	
	ARCHED TOP - 25% Upcharge	<input type="checkbox"/>	
PRICING INSTRUCTIONS			\$ -
ENTER PRICE INTO BLUE CELL			
HANGING OPTIONS:	FLUSH MOUNT (WOOD/SIDING) INCLUDED	<input type="checkbox"/>	
	FACE MOUNT (CONCRETE/BRICK)	<input type="checkbox"/>	
	HINGES (SEE HARDWARE PAGE)	<input type="checkbox"/>	
<a href="#">HARDWARE PAGE LINK</a>			
TOTAL			\$ -

\*Sold in Pairs  
 \*\*Prices reflect double panel shutters with even sized panels.  
 \*Prices subject to change without notice

PRICE LEVEL
NON-STOCKING

**DECOR COLLECTION SHUTTERS - 2017**

**BOARD & BATTEN**

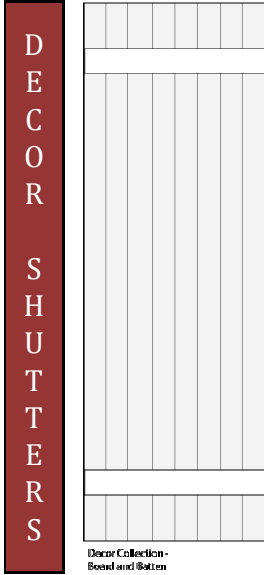

		WIDTH										
		12	14	16	18	20	22	24	26	28	30	32
H E I G H T	24	\$123.25	\$143.78	\$164.32	\$184.86	\$205.40	\$225.94	\$246.48	\$267.03	\$287.57	\$308.11	\$328.65
	30	\$154.05	\$179.73	\$205.40	\$231.08	\$256.76	\$282.43	\$308.11	\$333.78	\$359.46	\$385.13	\$410.81
	36	\$184.86	\$215.68	\$246.48	\$277.30	\$308.11	\$338.91	\$369.73	\$400.54	\$431.35	\$462.16	\$492.97
	42	\$215.68	\$251.62	\$287.57	\$323.52	\$359.46	\$395.41	\$431.35	\$467.29	\$503.24	\$539.18	\$575.13
	48	\$246.48	\$287.57	\$328.65	\$369.73	\$410.81	\$451.89	\$492.97	\$534.05	\$575.13	\$616.22	\$657.30
	54	\$277.30	\$323.52	\$369.73	\$415.95	\$462.16	\$508.38	\$554.59	\$600.81	\$647.02	\$693.24	\$739.45
	60	\$308.11	\$359.46	\$410.81	\$462.16	\$513.51	\$564.86	\$616.22	\$667.56	\$718.91	\$770.27	\$821.62
	66	\$338.91	\$395.41	\$451.89	\$508.38	\$564.86	\$621.35	\$677.84	\$734.32	\$790.81	\$847.29	\$903.78
	72	\$369.73	\$431.35	\$492.97	\$554.59	\$616.22	\$677.84	\$739.45	\$801.08	\$862.70	\$924.32	\$985.94
	78	\$400.54	\$467.29	\$534.05	\$600.81	\$667.56	\$734.32	\$801.08	\$867.83	\$934.59	\$1,001.35	\$1,068.10
	84	\$431.35	\$503.24	\$575.13	\$647.02	\$718.91	\$790.81	\$862.70	\$934.59	\$1,006.48	\$1,078.38	\$1,150.27
	90	\$462.16	\$539.18	\$616.22	\$693.24	\$770.27	\$847.29	\$924.32	\$1,001.35	\$1,078.38	\$1,155.40	\$1,232.43
	96	\$492.97	\$575.13	\$657.30	\$739.45	\$821.62	\$903.78	\$985.94	\$1,068.10	\$1,150.27	\$1,232.43	\$1,314.59
	102	\$523.79	\$611.08	\$698.38	\$785.67	\$872.97	\$960.26	\$1,047.56	\$1,134.86	\$1,222.16	\$1,309.45	\$1,396.75
108	\$554.59	\$647.02	\$739.45	\$831.89	\$924.32	\$1,016.75	\$1,109.18	\$1,201.62	\$1,294.05	\$1,386.49	\$1,478.92	
114	\$585.40	\$682.97	\$780.54	\$878.11	\$975.67	\$1,073.24	\$1,170.81	\$1,268.37	\$1,365.94	\$1,463.51	\$1,561.07	
120	\$616.22	\$718.91	\$821.62	\$924.32	\$1,027.02	\$1,129.73	\$1,232.43	\$1,335.13	\$1,437.83	\$1,540.54	\$1,643.24	

**\*\*PRICES SUBJECT TO CHANGE WITHOUT NOTICE**

SHUTTER OPTIONS		SELECT	SELECTED OPTIONS
FRAMES	SINGLE PANEL - 5% Upcharge	<input type="checkbox"/>	
	TRIPLE PANEL - 10% Upcharge	<input type="checkbox"/>	
	CUSTOM RAIL - 15% Upcharge	<input type="checkbox"/>	
	CUSTOM SHUTTER DETAIL - 25% Upcharge	<input type="checkbox"/>	
	ARCHED TOP - 25% Upcharge	<input type="checkbox"/>	
PRICING INSTRUCTIONS			
ENTER PRICE INTO BLUE CELL			
HANGING OPTIONS:	FLUSH MOUNT (WOOD/SIDING) INCLUDED	<input type="checkbox"/>	
	FACE MOUNT (CONCRETE/BRICK)	<input type="checkbox"/>	
	HINGES (SEE HARDWARE PAGE)	<input type="checkbox"/>	
<a href="#">HARDWARE PAGE LINK</a>			
TOTAL		\$	-

\*Sold in Pairs  
 \*\*Prices reflect double panel shutters with even sized panels.  
 \*Prices subject to change without notice

PRICE LEVEL
NON-STOCKING

**DECOR COLLECTION SHUTTERS - 2017**

**BOARD & "Z" BATTEN**

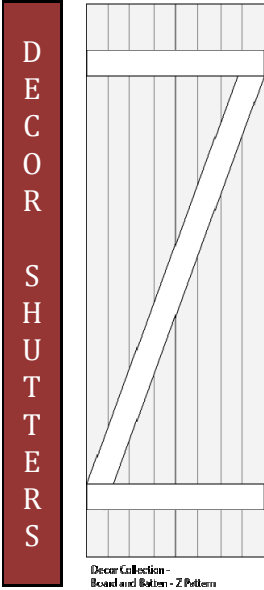

H E I G H T	W I D T H										
	12	14	16	18	20	22	24	26	28	30	32
24	\$129.13	\$150.66	\$172.18	\$193.70	\$215.22	\$236.74	\$258.27	\$279.79	\$301.31	\$322.83	\$344.35
30	\$161.42	\$188.32	\$215.22	\$242.12	\$269.03	\$295.93	\$322.83	\$349.74	\$376.63	\$403.54	\$430.45
36	\$193.70	\$225.98	\$258.27	\$290.55	\$322.83	\$355.11	\$387.39	\$419.69	\$451.97	\$484.25	\$516.53
42	\$225.98	\$263.64	\$301.31	\$338.98	\$376.63	\$414.30	\$451.97	\$489.62	\$527.29	\$564.96	\$602.62
48	\$258.27	\$301.31	\$344.35	\$387.39	\$430.45	\$473.49	\$516.53	\$559.57	\$602.62	\$645.66	\$688.71
54	\$290.55	\$338.98	\$387.39	\$435.82	\$484.25	\$532.67	\$581.10	\$629.52	\$677.95	\$726.37	\$774.80
60	\$322.83	\$376.63	\$430.45	\$484.25	\$538.05	\$591.86	\$645.66	\$699.47	\$753.28	\$807.08	\$860.88
66	\$355.11	\$414.30	\$473.49	\$532.67	\$591.86	\$651.05	\$710.23	\$769.41	\$828.60	\$887.79	\$946.98
72	\$387.39	\$451.97	\$516.53	\$581.10	\$645.66	\$710.23	\$774.80	\$839.36	\$903.93	\$968.50	\$1,033.06
78	\$419.69	\$489.62	\$559.57	\$629.52	\$699.47	\$769.41	\$839.36	\$909.31	\$979.26	\$1,049.20	\$1,119.15
84	\$451.97	\$527.29	\$602.62	\$677.95	\$753.28	\$828.60	\$903.93	\$979.26	\$1,054.58	\$1,129.91	\$1,205.23
90	\$484.25	\$564.96	\$645.66	\$726.37	\$807.08	\$887.79	\$968.50	\$1,049.20	\$1,129.91	\$1,210.62	\$1,291.33
96	\$516.53	\$602.62	\$688.71	\$774.80	\$860.88	\$946.98	\$1,033.06	\$1,119.15	\$1,205.23	\$1,291.33	\$1,377.41
102	\$548.81	\$640.28	\$731.76	\$823.23	\$914.69	\$1,006.16	\$1,097.63	\$1,189.10	\$1,280.57	\$1,372.04	\$1,463.50
108	\$581.10	\$677.95	\$774.80	\$871.64	\$968.50	\$1,065.35	\$1,162.19	\$1,259.05	\$1,355.89	\$1,452.74	\$1,549.60
114	\$613.38	\$715.61	\$817.84	\$920.07	\$1,022.30	\$1,124.53	\$1,226.77	\$1,328.99	\$1,431.22	\$1,533.45	\$1,635.68
120	\$645.66	\$753.28	\$860.88	\$968.50	\$1,076.11	\$1,183.71	\$1,291.33	\$1,398.94	\$1,506.55	\$1,614.16	\$1,721.77

**\*\*PRICES SUBJECT TO CHANGE WITHOUT NOTICE**

SHUTTER OPTIONS		SELECT	SELECTED OPTIONS
FRAMES	SINGLE PANEL - 5% Upcharge	<input type="checkbox"/>	
	TRIPLE PANEL - 10% Upcharge	<input type="checkbox"/>	
	CUSTOM RAIL - 15% Upcharge	<input type="checkbox"/>	
	CUSTOM SHUTTER DETAIL - 25% Upcharge	<input type="checkbox"/>	
	ARCHED TOP - 25% Upcharge	<input type="checkbox"/>	
PRICING INSTRUCTIONS			\$ -
ENTER PRICE INTO BLUE CELL			
HANGING OPTIONS:	FLUSH MOUNT (WOOD/SIDING) INCLUDED	<input type="checkbox"/>	
	FACE MOUNT (CONCRETE/BRICK)	<input type="checkbox"/>	
	HINGES (SEE HARDWARE PAGE)	<input type="checkbox"/>	
<a href="#">HARDWARE PAGE LINK</a>			
TOTAL			\$ -

\*Sold in Pairs

\*\*Prices reflect double panel shutters with even sized panels.

\*Prices subject to change without notice

**DISTINCTIVE COLLECTION SHUTTERS - 2017**

**RAISED PANEL**

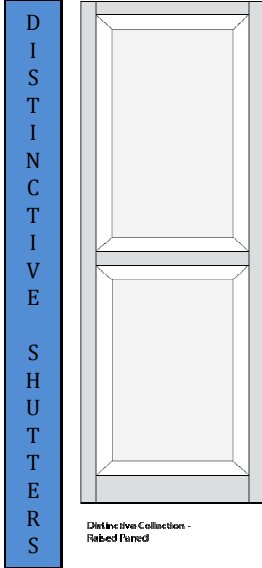

H E I G H T	W I D T H										
	12	14	16	18	20	22	24	26	28	30	32
24	\$ 127.27	\$ 148.47	\$ 169.69	\$ 190.89	\$ 212.11	\$ 233.32	\$ 254.53	\$ 275.74	\$ 296.95	\$ 318.16	\$ 339.38
30	\$ 159.08	\$ 185.59	\$ 212.11	\$ 238.62	\$ 265.13	\$ 291.65	\$ 318.16	\$ 344.68	\$ 371.18	\$ 397.70	\$ 424.22
36	\$ 190.89	\$ 222.71	\$ 254.53	\$ 286.34	\$ 318.16	\$ 349.98	\$ 381.80	\$ 413.61	\$ 445.43	\$ 477.24	\$ 509.06
42	\$ 222.71	\$ 259.83	\$ 296.95	\$ 334.07	\$ 371.18	\$ 408.31	\$ 445.43	\$ 482.55	\$ 519.67	\$ 556.79	\$ 593.90
48	\$ 254.53	\$ 296.95	\$ 339.38	\$ 381.80	\$ 424.22	\$ 466.64	\$ 509.06	\$ 551.49	\$ 593.90	\$ 636.32	\$ 678.74
54	\$ 286.34	\$ 334.07	\$ 381.80	\$ 429.52	\$ 477.24	\$ 524.97	\$ 572.69	\$ 620.41	\$ 668.14	\$ 715.86	\$ 763.59
60	\$ 318.16	\$ 371.18	\$ 424.22	\$ 477.24	\$ 530.27	\$ 583.29	\$ 636.32	\$ 689.35	\$ 742.38	\$ 795.40	\$ 848.43
66	\$ 349.98	\$ 408.31	\$ 466.64	\$ 524.97	\$ 583.29	\$ 641.63	\$ 699.96	\$ 758.28	\$ 816.62	\$ 874.95	\$ 933.27
72	\$ 381.80	\$ 445.43	\$ 509.06	\$ 572.69	\$ 636.32	\$ 699.96	\$ 763.59	\$ 827.22	\$ 890.85	\$ 954.49	\$ 1,018.12
78	\$ 413.61	\$ 482.55	\$ 551.49	\$ 620.41	\$ 689.35	\$ 758.28	\$ 827.22	\$ 896.15	\$ 965.09	\$ 1,034.02	\$ 1,102.96
84	\$ 445.43	\$ 519.67	\$ 593.90	\$ 668.14	\$ 742.38	\$ 816.62	\$ 890.85	\$ 965.09	\$ 1,039.33	\$ 1,113.56	\$ 1,187.80
90	\$ 477.24	\$ 556.79	\$ 636.32	\$ 715.86	\$ 795.40	\$ 874.95	\$ 954.49	\$ 1,034.02	\$ 1,113.56	\$ 1,193.11	\$ 1,272.65
96	\$ 509.06	\$ 593.90	\$ 678.74	\$ 763.59	\$ 848.43	\$ 933.27	\$ 1,018.12	\$ 1,102.96	\$ 1,187.80	\$ 1,272.65	\$ 1,357.49
102	\$ 540.87	\$ 631.02	\$ 721.16	\$ 811.31	\$ 901.45	\$ 991.61	\$ 1,081.75	\$ 1,171.90	\$ 1,262.05	\$ 1,352.19	\$ 1,442.34
108	\$ 572.69	\$ 668.14	\$ 763.59	\$ 859.03	\$ 954.49	\$ 1,049.94	\$ 1,145.38	\$ 1,240.83	\$ 1,336.28	\$ 1,431.72	\$ 1,527.18
114	\$ 604.51	\$ 705.26	\$ 806.01	\$ 906.77	\$ 1,007.51	\$ 1,108.26	\$ 1,209.01	\$ 1,309.77	\$ 1,410.52	\$ 1,511.27	\$ 1,612.02
120	\$ 636.32	\$ 742.38	\$ 848.43	\$ 954.49	\$ 1,060.54	\$ 1,166.59	\$ 1,272.65	\$ 1,378.70	\$ 1,484.76	\$ 1,590.81	\$ 1,696.87

**\*\*PRICES SUBJECT TO CHANGE WITHOUT NOTICE**

SHUTTER OPTIONS		SELECT	SELECTED OPTIONS
FRAMES	SINGLE PANEL - 5% Upcharge	<input type="checkbox"/>	
	TRIPLE PANEL - 10% Upcharge	<input type="checkbox"/>	
	CUSTOM RAIL - 15% Upcharge	<input type="checkbox"/>	
	CUSTOM SHUTTER DETAIL - 25% Upcharge	<input type="checkbox"/>	
	ARCHED TOP - 25% Upcharge	<input type="checkbox"/>	
PRICING INSTRUCTIONS			\$ -
ENTER PRICE INTO BLUE CELL			
HANGING OPTIONS:	FLUSH MOUNT (WOOD/SIDING) INCLUDED	<input type="checkbox"/>	
	FACE MOUNT (CONCRETE/BRICK)	<input type="checkbox"/>	
	HINGES (SEE HARDWARE PAGE)	<input type="checkbox"/>	
<a href="#">HARDWARE PAGE LINK</a>			
TOTAL			\$ -

\*Sold in Pairs

\*\*Prices reflect double panel shutters with even sized panels.

\*Prices subject to change without notice

PRICE LEVEL
NON-STOCKING





**DISTINCTIVE COLLECTION SHUTTERS - 2017**



**RECESSED PANEL**

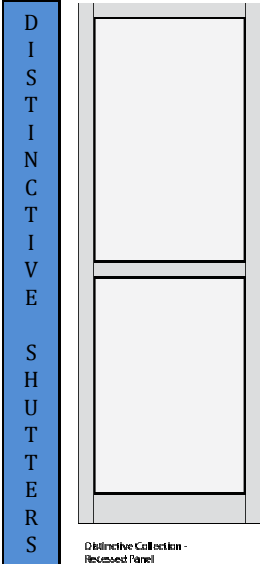

HEIGHT	WIDTH										
	12	14	16	18	20	22	24	26	28	30	32
24	\$ 117.23	\$ 136.76	\$ 156.31	\$ 175.85	\$ 195.38	\$ 214.92	\$ 234.45	\$ 254.00	\$ 273.54	\$ 293.07	\$ 312.61
30	\$ 146.53	\$ 170.96	\$ 195.38	\$ 219.81	\$ 244.22	\$ 268.65	\$ 293.07	\$ 317.50	\$ 341.91	\$ 366.34	\$ 390.76
36	\$ 175.85	\$ 205.15	\$ 234.45	\$ 263.77	\$ 293.07	\$ 322.38	\$ 351.69	\$ 380.99	\$ 410.30	\$ 439.60	\$ 468.92
42	\$ 205.15	\$ 239.34	\$ 273.54	\$ 307.73	\$ 341.91	\$ 376.10	\$ 410.30	\$ 444.49	\$ 478.68	\$ 512.88	\$ 547.07
48	\$ 234.45	\$ 273.54	\$ 312.61	\$ 351.69	\$ 390.76	\$ 429.83	\$ 468.92	\$ 507.99	\$ 547.07	\$ 586.14	\$ 625.22
54	\$ 263.77	\$ 307.73	\$ 351.69	\$ 395.65	\$ 439.60	\$ 483.56	\$ 527.52	\$ 571.49	\$ 615.45	\$ 659.41	\$ 703.37
60	\$ 293.07	\$ 341.91	\$ 390.76	\$ 439.60	\$ 488.45	\$ 537.29	\$ 586.14	\$ 634.98	\$ 683.83	\$ 732.67	\$ 781.52
66	\$ 322.38	\$ 376.10	\$ 429.83	\$ 483.56	\$ 537.29	\$ 591.02	\$ 644.76	\$ 698.49	\$ 752.22	\$ 805.95	\$ 859.68
72	\$ 351.69	\$ 410.30	\$ 468.92	\$ 527.52	\$ 586.14	\$ 644.76	\$ 703.37	\$ 761.99	\$ 820.60	\$ 879.22	\$ 937.82
78	\$ 380.99	\$ 444.49	\$ 507.99	\$ 571.49	\$ 634.98	\$ 698.49	\$ 761.99	\$ 825.49	\$ 888.98	\$ 952.48	\$ 1,015.98
84	\$ 410.30	\$ 478.68	\$ 547.07	\$ 615.45	\$ 683.83	\$ 752.22	\$ 820.60	\$ 888.98	\$ 957.37	\$ 1,025.75	\$ 1,094.13
90	\$ 439.60	\$ 512.88	\$ 586.14	\$ 659.41	\$ 732.67	\$ 805.95	\$ 879.22	\$ 952.48	\$ 1,025.75	\$ 1,099.02	\$ 1,172.29
96	\$ 468.92	\$ 547.07	\$ 625.22	\$ 703.37	\$ 781.52	\$ 859.68	\$ 937.82	\$ 1,015.98	\$ 1,094.13	\$ 1,172.29	\$ 1,250.44
102	\$ 498.22	\$ 581.25	\$ 664.30	\$ 747.33	\$ 830.36	\$ 913.41	\$ 996.44	\$ 1,079.47	\$ 1,162.52	\$ 1,245.55	\$ 1,328.59
108	\$ 527.52	\$ 615.45	\$ 703.37	\$ 791.29	\$ 879.22	\$ 967.14	\$ 1,055.06	\$ 1,142.98	\$ 1,230.89	\$ 1,318.82	\$ 1,406.74
114	\$ 556.84	\$ 649.64	\$ 742.45	\$ 835.25	\$ 928.06	\$ 1,020.87	\$ 1,113.67	\$ 1,206.48	\$ 1,299.28	\$ 1,392.09	\$ 1,484.89
120	\$ 586.14	\$ 683.83	\$ 781.52	\$ 879.22	\$ 976.91	\$ 1,074.60	\$ 1,172.29	\$ 1,269.98	\$ 1,367.67	\$ 1,465.36	\$ 1,563.05

**\*\*PRICES SUBJECT TO CHANGE WITHOUT NOTICE**

SHUTTER OPTIONS		SELECT	SELECTED OPTIONS
FRAMES	SINGLE PANEL - 5% Upcharge	<input type="checkbox"/>	
	TRIPLE PANEL - 10% Upcharge	<input type="checkbox"/>	
	CUSTOM RAIL - 15% Upcharge	<input type="checkbox"/>	
	CUSTOM SHUTTER DETAIL - 25% Upcharge	<input type="checkbox"/>	
	ARCHED TOP - 25% Upcharge	<input type="checkbox"/>	
PRICING INSTRUCTIONS			\$ -
ENTER PRICE INTO BLUE CELL			
HANGING OPTIONS:	FLUSH MOUNT (WOOD/SIDING) INCLUDED	<input type="checkbox"/>	
	FACE MOUNT (CONCRETE/BRICK)	<input type="checkbox"/>	
	HINGES (SEE HARDWARE PAGE)	<input type="checkbox"/>	
<a href="#">HARDWARE PAGE LINK</a>			
TOTAL			\$ -

\*Sold in Pairs  
 \*\*Prices reflect double panel shutters with even sized panels.  
 \*Prices subject to change without notice

PRICE LEVEL
NON-STOCKING

**DISTINCTIVE COLLECTION SHUTTERS - 2017**

**CLOSED LOUVRE**

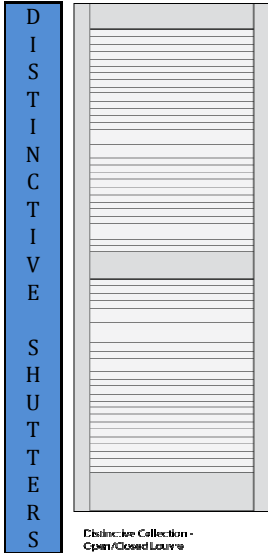

H E I G H T	W I D T H										
	12	14	16	18	20	22	24	26	28	30	32
24	\$ 143.73	\$ 167.68	\$ 191.64	\$ 215.59	\$ 239.54	\$ 263.50	\$ 287.45	\$ 311.41	\$ 335.36	\$ 359.33	\$ 383.28
30	\$ 179.66	\$ 209.61	\$ 239.54	\$ 269.49	\$ 299.43	\$ 329.38	\$ 359.33	\$ 389.26	\$ 419.21	\$ 449.15	\$ 479.10
36	\$ 215.59	\$ 251.53	\$ 287.45	\$ 323.39	\$ 359.33	\$ 395.25	\$ 431.19	\$ 467.12	\$ 503.05	\$ 538.98	\$ 574.92
42	\$ 251.53	\$ 293.44	\$ 335.36	\$ 377.29	\$ 419.21	\$ 461.12	\$ 503.05	\$ 544.97	\$ 586.89	\$ 628.82	\$ 670.73
48	\$ 287.45	\$ 335.36	\$ 383.28	\$ 431.19	\$ 479.10	\$ 527.01	\$ 574.92	\$ 622.82	\$ 670.73	\$ 718.64	\$ 766.55
54	\$ 323.39	\$ 377.29	\$ 431.19	\$ 485.08	\$ 538.98	\$ 592.88	\$ 646.78	\$ 700.68	\$ 754.58	\$ 808.47	\$ 862.37
60	\$ 359.33	\$ 419.21	\$ 479.10	\$ 538.98	\$ 598.87	\$ 658.75	\$ 718.64	\$ 778.53	\$ 838.41	\$ 898.30	\$ 958.19
66	\$ 395.25	\$ 461.12	\$ 527.01	\$ 592.88	\$ 658.75	\$ 724.63	\$ 790.51	\$ 856.38	\$ 922.26	\$ 988.13	\$ 1,054.00
72	\$ 431.19	\$ 503.05	\$ 574.92	\$ 646.78	\$ 718.64	\$ 790.51	\$ 862.37	\$ 934.23	\$ 1,006.09	\$ 1,077.96	\$ 1,149.83
78	\$ 467.12	\$ 544.97	\$ 622.82	\$ 700.68	\$ 778.53	\$ 856.38	\$ 934.23	\$ 1,012.09	\$ 1,089.94	\$ 1,167.79	\$ 1,245.65
84	\$ 503.05	\$ 586.89	\$ 670.73	\$ 754.58	\$ 838.41	\$ 922.26	\$ 1,006.09	\$ 1,089.94	\$ 1,173.79	\$ 1,257.62	\$ 1,341.47
90	\$ 538.98	\$ 628.82	\$ 718.64	\$ 808.47	\$ 898.30	\$ 988.13	\$ 1,077.96	\$ 1,167.79	\$ 1,257.62	\$ 1,347.46	\$ 1,437.28
96	\$ 574.92	\$ 670.73	\$ 766.55	\$ 862.37	\$ 958.19	\$ 1,054.00	\$ 1,149.83	\$ 1,245.65	\$ 1,341.47	\$ 1,437.28	\$ 1,533.10
102	\$ 610.84	\$ 712.65	\$ 814.46	\$ 916.27	\$ 1,018.08	\$ 1,119.89	\$ 1,221.69	\$ 1,323.50	\$ 1,425.30	\$ 1,527.11	\$ 1,628.92
108	\$ 646.78	\$ 754.58	\$ 862.37	\$ 970.17	\$ 1,077.96	\$ 1,185.76	\$ 1,293.56	\$ 1,401.35	\$ 1,509.15	\$ 1,616.95	\$ 1,724.74
114	\$ 682.71	\$ 796.50	\$ 910.28	\$ 1,024.07	\$ 1,137.85	\$ 1,251.63	\$ 1,365.42	\$ 1,479.20	\$ 1,592.99	\$ 1,706.77	\$ 1,820.55
120	\$ 718.64	\$ 838.41	\$ 958.19	\$ 1,077.96	\$ 1,197.74	\$ 1,317.51	\$ 1,437.28	\$ 1,557.06	\$ 1,676.83	\$ 1,796.60	\$ 1,916.38

**\*\*PRICES SUBJECT TO CHANGE WITHOUT NOTICE**

SHUTTER OPTIONS		SELECT	SELECTED OPTIONS
FRAMES	SINGLE PANEL - 5% Upcharge	<input type="checkbox"/>	
	TRIPLE PANEL - 10% Upcharge	<input type="checkbox"/>	
	CUSTOM RAIL - 15% Upcharge	<input type="checkbox"/>	
	CUSTOM SHUTTER DETAIL - 25% Upcharge	<input type="checkbox"/>	
	ARCHED TOP - 25% Upcharge	<input type="checkbox"/>	
PRICING INSTRUCTIONS			
ENTER PRICE INTO BLUE CELL			
HANGING OPTIONS:	FLUSH MOUNT (WOOD/SIDING) INCLUDED	<input type="checkbox"/>	
	FACE MOUNT (CONCRETE/BRICK)	<input type="checkbox"/>	
	HINGES (SEE HARDWARE PAGE)	<input type="checkbox"/>	
<a href="#">HARDWARE PAGE LINK</a>			
		TOTAL	\$ -

\*Sold in Pairs

\*\*Prices reflect double panel shutters with even sized panels.

\*Prices subject to change without notice

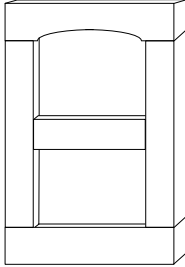

RECESSED PANEL

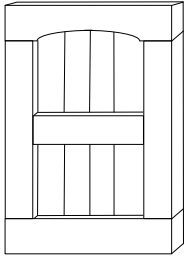

V GROOVE

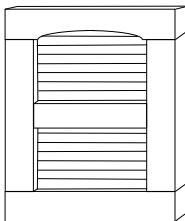

CLOSED LOUVRE

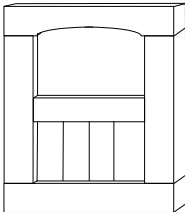

MIXED PANELS

FLEX SHUTTERS

PRODUCT CODE	DESCRIPTION
SFRFV-1648	16" x 48" Reversible Shutter (V Groove/Recessed)
SFRFV-1660	16" x 60" Reversible Shutter (V Groove/Recessed)
SFRFV-1672	16" x 72" Reversible Shutter (V Groove/Recessed)
SFRLF-1648	16" x 48" Reversible Shutter (Closed Louvre/Recessed)
SFRLF-1660	16" x 60" Reversible Shutter (Closed Louvre/Recessed)
SFRLF-1672	16" x 72" Reversible Shutter (Closed Louvre/Recessed)

TOP FRAME ACCESSORIES

SFACC-RT	Round Top (16" Full Round)
SFACC-HT	Half Round Top (16" 1/4 Round)
SFACC-TT	Tapered Top (16" Taper)
SFACC-LA	Low Arch Top (8" 1/4 Round)
SFACC-LR	Round Top (Low)(8" Full Round)

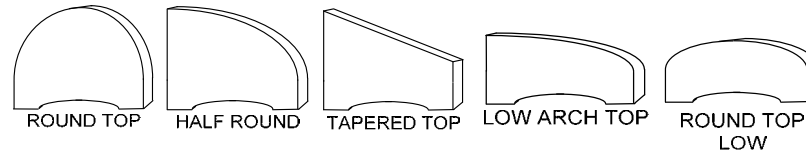

\*SHUTTERS CAN BE CUT TO SUIT HEIGHT

\*SELECT "V" GROOVE OR RECESSED PANEL OR CLOSED LOUVRE OR MIX MATCH (I.E. RECESSED/"V" GROOVE)

\*\*PRICES SUBJECT TO CHANGE WITHOUT NOTICE

PRICE LEVEL
NON-STOCKING

PAIR COST	
\$	247.30
\$	276.60
\$	283.19
\$	303.83
\$	333.14
\$	339.72

\$	56.04
\$	56.04
\$	56.04
\$	31.31
\$	31.31

PRESTIGE LOUVRES - 2017

P  
R  
E  
S  
T  
I  
G  
E  
  
L  
O  
U  
V  
R  
E  
S

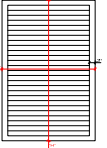
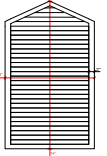
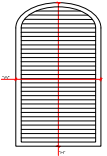
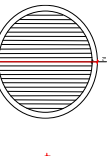
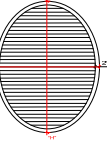
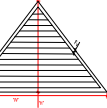
	PRODUCT CODE	DESCRIPTION	WIDTH (IN)	HEIGHT (IN)	STANDARD PACKAGE
 <p>RECTANGLE</p>	LPC3G-12(24)	Prestige PVC Louvre, 12" x 24" Rectangle, Closed Louvre /w Brick Mould Surround & Sill	12	24	\$ 42.85
	LPC3G-16(36)	Prestige PVC Louvre, 16" x 36" Rectangle, Closed Louvre /w Brick Mould Surround & Sill	16	36	\$ 62.27
	LPC3G-20(48)	Prestige PVC Louvre, 20" x 48" Rectangle, Closed Louvre /w Brick Mould Surround & Sill	20	48	\$ 95.99
 <p>PEAK TOP</p>	LPC3K-12(48)	Prestige PVC Louvre, 12" x 24" Peak Top Rectangle, Closed Louvre /w Brick Mould Surround & Sill	12	48	\$ 46.33
	LPC3K-16(48)	Prestige PVC Louvre, 16" x 36" Peak Top Rectangle, Closed Louvre /w Brick Mould Surround & Sill	16	48	\$ 67.33
	LPC3K-20(48)	Prestige PVC Louvre, 20" x 48" Peak Top Rectangle, Closed Louvre /w Brick Mould Surround & Sill	20	48	\$ 103.77
 <p>ROUND TOP</p>	LPC3H-12(48)	Prestige PVC Louvre, 12" x 24" Round Top Rectangle, Closed Louvre /w Brick Mould Surround & Sill	12	48	\$ 48.65
	LPC3H-16(48)	Prestige PVC Louvre, 16" x 36" Round Top Rectangle, Closed Louvre /w Brick Mould Surround & Sill	16	48	\$ 70.69
	LPC3H-20(48)	Prestige PVC Louvre, 20" x 48" Round Top Rectangle, Closed Louvre /w Brick Mould Surround & Sill	20	48	\$ 108.97
 <p>ROUND</p>	LPC1A-16	Prestige PVC Louvre, 16"ID Round, Closed Louvre /w 4/4" x 3 1/2" Frame	16	16	\$ 53.32
	LPC1A-20	Prestige PVC Louvre, 20"ID Round, Closed Louvre /w 4/4" x 3 1/2" Frame	20	20	\$ 68.77
	LPC1A-24	Prestige PVC Louvre, 24"ID Round, Closed Louvre /w 4/4" x 3 1/2" Frame	24	24	\$ 75.77
 <p>OVAL</p>	LPC1C-16(36)	Prestige PVC Louvre, 16" x 36"ID Oval, Closed Louvre /w 4/4" x 3 1/2" Frame	16	36	\$ 104.35
	LPC1C-18(42)	Prestige PVC Louvre, 18" x 42"ID Oval, Closed Louvre /w 4/4" x 3 1/2" Frame	18	42	\$ 137.79
	LPC1C-22(48)	Prestige PVC Louvre, 22" x 48"ID Oval, Closed Louvre /w 4/4" x 3 1/2" Frame	22	48	\$ 160.86
 <p>TRIANGLE</p>	LPC3F-12(48)	Prestige PVC Louvre, 12" x 24" Triangle, Closed Louvre /w Brick Mould Surround & Sill	12	48	\$ 60.22
	LPC3F-16(48)	Prestige PVC Louvre, 16" x 36" Triangle Rectangle, Closed Louvre /w Brick Mould Surround & Sill	16	48	\$ 87.52
	LPC3F-20(48)	Prestige PVC Louvre, 20" x 48" Triangle Rectangle, Closed Louvre /w Brick Mould Surround & Sill	20	48	\$ 134.90

\*\*PRICES SUBJECT TO CHANGE WITHOUT NOTICE

HEIGHT	WIDTH											
	12	14	16	18	20	22	24	26	28	30	32	48
24	\$23.16	\$24.91	\$26.66	\$32.63	\$34.38	\$36.14	\$37.89	\$39.63	\$54.05	\$55.80	\$57.54	\$71.54
30	\$25.79	\$27.97	\$30.16	\$36.57	\$38.76	\$40.95	\$43.14	\$45.32	\$60.17	\$62.36	\$64.54	\$82.05
36	\$28.42	\$31.04	\$33.67	\$40.51	\$43.14	\$45.76	\$48.39	\$51.02	\$66.30	\$68.93	\$71.54	\$92.56
42	\$31.04	\$34.10	\$37.16	\$44.45	\$47.51	\$50.57	\$53.63	\$56.70	\$72.42	\$75.48	\$78.55	\$103.06
48	\$33.67	\$37.16	\$40.67	\$48.39	\$51.89	\$55.39	\$58.89	\$62.39	\$78.55	\$82.05	\$85.56	\$113.56
54	\$36.29	\$40.23	\$44.16	\$52.32	\$56.26	\$60.20	\$64.14	\$68.08	\$84.68	\$88.62	\$92.56	\$124.06
60	\$38.91	\$43.30	\$47.67	\$56.26	\$60.64	\$65.02	\$69.39	\$73.77	\$90.81	\$95.18	\$99.56	\$134.57
66	\$45.76	\$50.57	\$55.39	\$72.86	\$77.68	\$82.48	\$87.30	\$92.11	\$105.84	\$110.65	\$115.46	\$153.98
72	\$48.39	\$53.63	\$58.89	\$76.80	\$82.05	\$87.30	\$92.56	\$97.81	\$111.97	\$117.22	\$122.46	\$164.48
78	\$51.02	\$56.70	\$62.39	\$80.74	\$86.42	\$92.11	\$97.81	\$103.50	\$118.09	\$123.78	\$129.47	\$174.98
84	\$53.63	\$59.77	\$65.89	\$84.68	\$90.81	\$96.93	\$103.06	\$109.18	\$124.22	\$130.34	\$136.47	\$185.49
90	\$56.26	\$62.83	\$69.39	\$88.62	\$95.18	\$101.75	\$108.30	\$114.87	\$130.34	\$136.91	\$143.47	\$195.98
96	\$58.89	\$65.89	\$72.90	\$92.56	\$99.56	\$106.56	\$113.56	\$120.56	\$136.47	\$143.47	\$150.47	\$206.49
102	\$74.17	\$81.62	\$89.05	\$105.40	\$112.84	\$120.28	\$127.72	\$135.16	\$180.11	\$187.55	\$194.98	\$254.50
108	\$76.80	\$84.68	\$92.56	\$109.34	\$117.22	\$125.09	\$132.97	\$140.85	\$186.24	\$194.11	\$201.99	\$265.00
114	\$79.42	\$87.74	\$96.05	\$113.28	\$121.59	\$129.91	\$138.22	\$146.53	\$192.36	\$200.67	\$208.99	\$275.50
120	\$82.05	\$90.81	\$99.56	\$117.22	\$125.97	\$134.72	\$143.47	\$152.22	\$198.49	\$207.24	\$215.99	\$286.01

\* ABOVE PRICES REFLECT FRAMELESS RECTANGLE LOUVRE

LOUVRE OPTIONS		SELECT	SELECTED OPTIONS
FRAMES	4/4" X 2" FRAME (4) - 50% Upcharge	<input type="checkbox"/>	
	BRICK MOULD (2) - 80% Upcharge	<input type="checkbox"/>	
	4/4" X 3 1/2" FRAME (6) - 100% Upcharge	<input type="checkbox"/>	
	4/4" X 5 1/2" FRAME (8) - 110% Upcharge	<input type="checkbox"/>	
	BOTTOM SILL - 5% Upcharge	<input type="checkbox"/>	
PEAK TOPLOUVRE (LPCK) - 15% Upcharge	<input type="checkbox"/>		
TRIANGLE LOUVRE (LPCF) - 75% Upcharge	<input type="checkbox"/>		
1/2 TRIANGLE LOUVRE LPCN) - 15% Upcharge	<input type="checkbox"/>		
ROUND LOUVRE (LPCA)-75% Upcharge (Red #'s for Frameless Round Louvre)	<input type="checkbox"/>		
ARCH TOP LOUVRE (LPCH - 25% Upcharge	<input type="checkbox"/>		
OVAL LOUVRE (LPCC) - 110% Upcharge	<input type="checkbox"/>		
PRICING INSTRUCTIONS			\$ -
PRICE	ENTER PRICE INTO BLUE CELL		

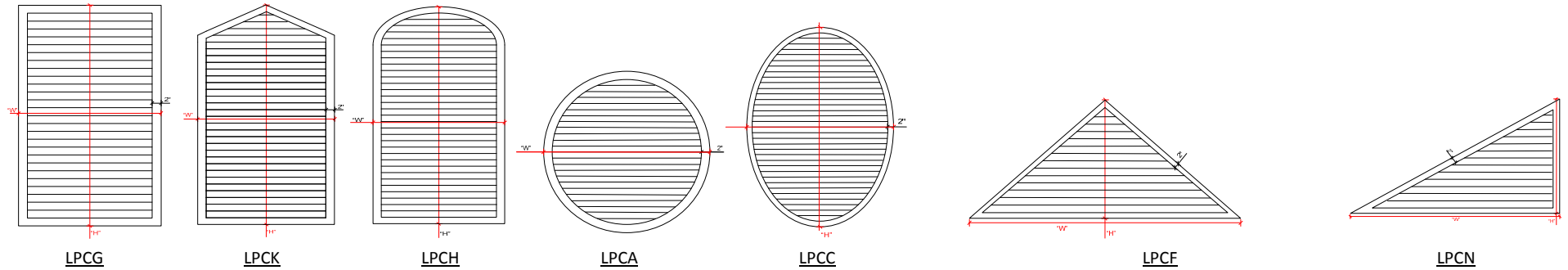
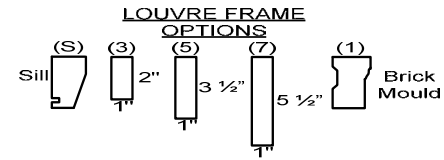

\*\*PRICES SUBJECT TO CHANGE WITHOUT NOTICE



# Assembly & Installation Instructions

Congratulations on your purchase of your new Prestige Gable™ Detail. These gables are designed to bring a classical architectural design to your home, and are engineered for easy installation. Before you begin your install, please take a few moments to unpack and review the contents of your package. Each Gable Detail will be installed behind the fascia board. You will need different fasteners depending on the application.

**Note:** The below installation instructions are suggested practices only. Fastener length may vary depending on product purchased. Ensure for 1" penetration into wood structure.

## Materials Included:

- One (1) gable post with mounting block
- Two (2) gable stretchers
- Four (4), #8, 3" galvanized wood screws
- Three (3) screws per side of stretcher
- Two (2) space blocks for each stretcher \*\*

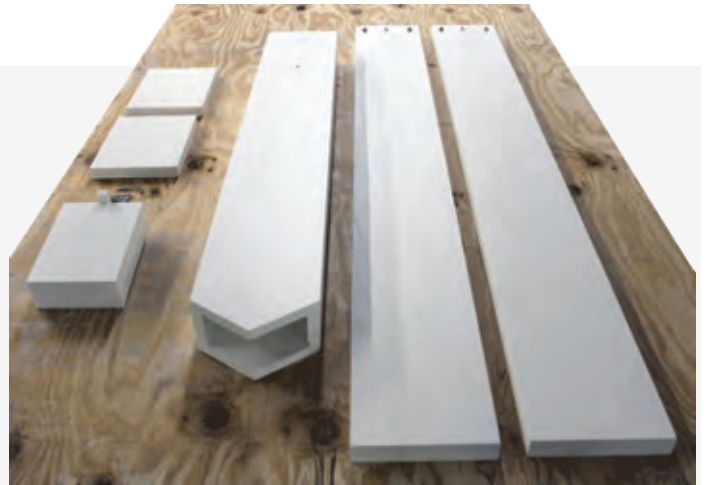

## Gable Detail: Assembly



- On a clean flat surface, layout the gable detail parts.
- Using spacers to adjust the depth, place the two gable stretchers at the desired height from the bottom of the gable post or line up with pre marked holes.

*It is recommended not to exceed 4" from the bottom of gable post.*

- Using the #8 galvanized wood screws provided, toe screw the stretcher to the middle gable post. The holes are pre drilled for easy assembly.



- Fasten both stretchers to either side of the gable post.



# Gable Detail: Installation Instructions

- Once the gable detail is assembled, remove the mounting block positioned in the gable post.

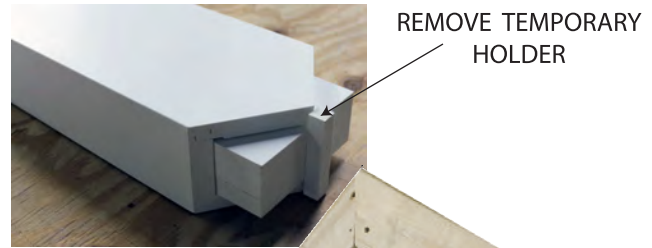

- Using the four (4) 3" #8 galvanized wood screws provided, fasten the mounting block to the top gable peak sub-fascia.

**\*\* Best method is to screw two (2) from back of fascia and two (2) from the front. \*\***

- Once mounting block is secured, with stretchers attached, slide gable post over block and fasten to the mounting block using four (4) 2" #8 galvanized wood screws. (Fasteners not included)



- Once gable post has been fastened to the mounting block, level post before fastening stretchers to sub fascia.



- Place block spacer (included) between stretcher and sub-fascia and using two (2) #8 galvanized wood screws, screw both into the back of the fascia, into the stretcher

- By screwing two (2) screws into both the front and back, you securely lock the gable into place both ways.

***Congratulations, your Prestige Gable is now completely installed and ready to enjoy. While not required, your gable can be painted.***



Innovative PVC Systems

[www.prestigedi.com](http://www.prestigedi.com)

**PRESTIGE GABLES - 2017**

**IMPORTANT: \* Standard Post widths and Stretcher heights are 3-1/2". \*\* Upgrade Post width and Stretcher height to 5-1/2" with 18% increase.**  
**Note: (X) Indicates the selection of inverted 'T' or inverted 'C' profiles. (i.e. D1 or D7)**

P R E S T I G E  
G A B L E S

**G1**



**G3**



	(X)		PRODUCT CODE		DESCRIPTION	FORMAT	
	INVERTED "T" GABLES	INVERTED "C" GABLES	G1	G3		1" POST (G1)	2 1/2" POST (G3)
D1		D7	G1i(X)b4145-72 G1i(X)b4148-96 G1i(X)b41411-144	G3i(X)b42.545-72 G3i(X)b42.548-96 G3i(X)b42.5412-144	Gable Detail - PVC, Inverted "T" or "Cross" @ 6' wide with ball (All Pitches) Gable Detail - PVC, Inverted "T" or "Cross" @ 8' wide with ball (All Pitches) Gable Detail - PVC, Inverted "T" or "Cross" @ 12' wide with ball (All Pitches) * Standard gable program designed to be cut to fit on-site if required	\$ 145.22	\$ 190.47
D2		D8	G1i(X)a1415-72 G1i(X)a1418-96 G1i(X)a14111-144	G3i(X)a42.545-72 G3i(X)a42.548-96 G3i(X)a42.5411-144	Gable Detail - PVC, Inverted "T" or "Cross" @ 6' wide (All Pitches) Gable Detail - PVC, Inverted "T" or "Cross", @ 8' wide (All Pitches) Gable Detail - PVC, Inverted "T" or "Cross" @ 12' wide (All Pitches) * Standard gable program designed to be cut to fit on-site if required	\$ 104.30	\$ 149.55
D3		D9	G1i(X)ab4145-72 G1i(X)ab4148-96 G1i(X)ab41411-144	G3i(X)ab42.545-72 G3i(X)ab42.548-96 G3i(X)ab42.5411-144	Gable Detail - PVC, Inverted "T" or "Cross", Arched @ 6' wide with ball (All Pitches) Gable Detail - PVC, Inverted "T" or "Cross", Arched @ 8' wide with ball (All Pitches) Gable Detail - PVC, Inverted "T" or "Cross", Arched, @ 12' wide with ball (All Pitches) * Standard gable program designed to be cut to fit on-site if required	\$ 185.52	\$ 274.17
D4		D10	G1i(X)a4145-72 G1i(X)a4148-96 G1i(X)a41411-144	G3i(X)a42.545-72 G3i(X)a42.548-96 G3i(X)a42.5411-144	Gable Detail - PVC, Inverted "T" or "Cross", Arched @ 6' wide (All Pitches) Gable Detail - PVC, Inverted "T" or "Cross", Arched @ 8' wide (All Pitches) Gable Detail - PVC, Inverted "T" or "Cross", Arched @ 12' wide (All Pitches) * Standard gable program designed to be cut to fit on-site if required	\$ 154.69	\$ 233.25
D5		D11	G1i(X)Vb4145-72 G1i(X)Vb4148-96 G1i(X)Vb41411-144	G3i(X)Vb42.545-72 G3i(X)Vb42.548-96 G3i(X)Vb42.5411-144	Gable Detail - PVC, Inverted "T" or "Cross" & "V" @ 6' wide with ball (All Pitches) Gable Detail - PVC, Inverted "T" or "Cross" & "V" @ 8' wide with ball (All Pitches) Gable Detail - PVC, Inverted "T" or "Cross" & "V" @ 12' wide with ball (All Pitches) * Standard gable program designed to be cut to fit on-site if required	\$ 189.69	\$ 306.16
D6		D12	G1i(X)V4145-72 G1i(X)V4148-96 G1i(X)V41411-144	G3i(X)V42.545-72 G3i(X)V42.548-96 G3i(X)V42.5411-144	Gable Detail - PVC, Inverted "T" or "Cross" & "V" @ 6' wide (All Pitches) Gable Detail - PVC, Inverted "T" or "Cross" & "V" @ 8' wide (All Pitches) Gable Detail - PVC, Inverted "T" or "Cross" & "V" @ 12' wide (All Pitches) * Standard gable program designed to be cut to fit on-site if required	\$ 148.77	\$ 265.24
D13		D15	G1i(X)Vab4145-72 G1i(X)Vab4148-96 G1i(X)Vab41411-144	G3i(X)Vab42.545-72 G3i(X)Vab42.548-96 G3i(X)Vab42.5411-144	Gable Detail - PVC, Inverted "T" or "Cross" & "V", Arched @ 6' wide with ball (All Pitches) Gable Detail - PVC, Inverted "T" or "Cross" & "V", Arched @ 8' wide with ball (All Pitches) Gable Detail - PVC, Inverted "T" or "Cross" & "V", Arched, @ 12' wide with ball (All Pitches) * Standard gable program designed to be cut to fit on-site if required	\$ 242.67	\$ 350.83
D14		D16	G1i(X)Va4145-72 G1i(X)Va4148-96 G1i(X)Va41411-144	G3i(X)Va42.545-72 G3i(X)Va42.548-96 G3i(X)Va42.5411-144	Gable Detail - PVC, Inverted "T" or "Cross" & "V", Arched @ 6' wide (All Pitches) Gable Detail - PVC, Inverted "T" or "Cross" & "V", Arched @ 8' wide (All Pitches) Gable Detail - PVC, Inverted "T" or "Cross" & "V", Arched @ 12' wide (All Pitches) * Standard gable program designed to be cut to fit on-site if required	\$ 201.75	\$ 309.91

**\*\*PRICES SUBJECT TO CHANGE WITHOUT NOTICE**

**PRESTIGE GINGERBREADS - 2017**

P R E S T I G E G I N G E R B R E A D S

PRODUCT CODE	DESCRIPTION	STANDARD PRICE
GDGB-23-07-12-72 GDGB-23-08-12-72 GDGB-23-09-12-72 GDGB-23-10-12-72 GDGB-23-11-12-72 GDGB-23-12-12-72	Gable Gingerbread - 2" P x 7/12 Pitch, 72" Wide Gable Gingerbread - 2" P x 8/12 Pitch, 72" Wide Gable Gingerbread - 2" P x 9/12 Pitch, 72" Wide Gable Gingerbread - 2" P x 10/12 Pitch, 72" Wide Gable Gingerbread - 2" P x 11/12 Pitch, 72" Wide Gable Gingerbread - 2" P x 12/12 Pitch, 72" Wide	\$ 300.30 \$ 324.32 \$ 350.26 \$ 378.29 \$ 408.55 \$ 441.23
GCGB101-667 GCGB101-865 GCGB101-1063 GCGB101-1272	Gable Detail - PVC - Gingerbread - Scroll 1, 1" P x 6/12 - 72" Wide Gable Detail - PVC - Gingerbread - Scroll 1, 1" P x 8/12 - 65" Wide Gable Detail - PVC - Gingerbread - Scroll 1, 1" P x 10/12 - 63" Wide Gable Detail - PVC - Gingerbread - Scroll 1, 1" P x 12/12 - 72" Wide	\$ 202.56 \$ 219.66 \$ 248.64 \$ 357.64
GDGB102-660 GDGB102-857 GDGB102-1057 GDGB102-1272	Gable Detail - PVC - Gingerbread - Scroll 2, 1" P x 6/12 - 60" Wide Gable Detail - PVC - Gingerbread - Scroll 2, 1" P x 8/12 - 57" Wide Gable Detail - PVC - Gingerbread - Scroll 2, 1" P x 10/12 - 57" Wide Gable Detail - PVC - Gingerbread - Scroll 2, 1" P x 12/12 - 72" Wide	\$ 232.25 \$ 243.22 \$ 280.52 \$ 376.52
GDGB103-665 GDGB103-860 GDGB103-1058 GDGB103-1272	Gable Detail - PVC - Gingerbread - Scallop /w Scroll, 1" P x 6/12 - 65 Gable Detail - PVC - Gingerbread - Scallop /w Scroll, 1" P x 8/12 - 60 Gable Detail - PVC - Gingerbread - Scallop /w Scroll, 1" P x 10/12 - 58 Gable Detail - PVC - Gingerbread - Scallop /w Scroll, 1" P x 12/12 - 72	\$ 259.49 \$ 288.88 \$ 308.78 \$ 433.15
GDGB104-660 GDGB104-857 GDGB104-1054 GDGB104-1272	Gable Detail - PVC - Gingerbread - Medallion 1, 1" P x 6/12 - 60 Gable Detail - PVC - Gingerbread - Medallion 1, 1" P x 8/12 - 57 Gable Detail - PVC - Gingerbread - Medallion 1, 1" P x 10/12 - 54 Gable Detail - PVC - Gingerbread - Medallion 1, 1" P x 12/12 - 72	\$ 219.96 \$ 224.34 \$ 227.09 \$ 357.64
GDGB105-664 GDGB105-860 GDGB105-1058 GDGB105-1272	Gable Detail - PVC - Gingerbread - Scroll 3, 1" P x 6/12 - 64" Wide Gable Detail - PVC - Gingerbread - Scroll 3, 1" P x 8/12 - 60" Wide Gable Detail - PVC - Gingerbread - Scroll 3, 1" P x 10/12 - 58" Wide Gable Detail - PVC - Gingerbread - Scroll 3, 1" P x 12/12 - 72" Wide	\$ 208.75 \$ 233.86 \$ 258.98 \$ 376.52
GDGB106-667 GDGB106-864 GDGB106-1061 GDGB106-1272	Gable Detail - PVC - Gingerbread - Owl Scroll, 1" P x 6/12 - 67" Wide Gable Detail - PVC - Gingerbread - Owl Scroll, 1" P x 8/12 - 64" Wide Gable Detail - PVC - Gingerbread - Owl Scroll, 1" P x 10/12 - 61" Wide Gable Detail - PVC - Gingerbread - Owl Scroll, 1" P x 12/12 - 72" Wide	\$ 206.78 \$ 229.12 \$ 247.93 \$ 376.52
GDGB107-662 GDGB107-860 GDGB107-1058 GDGB107-1272	Gable Detail - PVC - Gingerbread - Marine Scroll, 1" P x 6/12 - 62" Wide Gable Detail - PVC - Gingerbread - Marine Scroll, 1" P x 8/12 - 60" Wide Gable Detail - PVC - Gingerbread - Marine Scroll, 1" P x 10/12 - 58" Wide Gable Detail - PVC - Gingerbread - Marine Scroll, 1" P x 12/12 - 72" Wide	\$ 204.04 \$ 225.98 \$ 258.96 \$ 376.52
GDGB108-670 GDGB108-865 GDGB108-1062 GDGB108-1272	Gable Detail - PVC - Gingerbread - Butterfly, 1" P x 6/12 - 70" Wide Gable Detail - PVC - Gingerbread - Butterfly, 1" P x 8/12 - 65" Wide Gable Detail - PVC - Gingerbread - Butterfly, 1" P x 10/12 - 62" Wide Gable Detail - PVC - Gingerbread - Butterfly, 1" P x 12/12 - 72" Wide	\$ 186.74 \$ 199.26 \$ 236.96 \$ 357.64

**\*\*PRICES SUBJECT TO CHANGE WITHOUT NOTICE**

**PRESTIGE PLANTERS - 2017**

PRICE LEVEL
NON-STOCKING

PRESTIGE PLANTERS

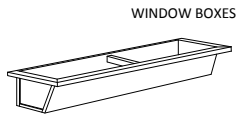

WINDOW BOXES

PRODUCT CODE	DESCRIPTION
PPW14	Flower -PVC-Window Box - 4'
PPW15	Flower -PVC-Window Box - 5'
PPW16	Flower -PVC-Window Box - 6'
PPW17	Flower -PVC-Window Box - 7'
PPW18	Flower -PVC-Window Box - 8'

	NATURAL FINISH	PRE-FINISHED
	\$ 124.22	\$ 161.48
	\$ 155.89	\$ 202.66
	\$ 186.93	\$ 243.02
	\$ 217.99	\$ 283.38
	\$ 248.39	\$ 322.91



#1

PPFL-CFMNTP-12	Flower -PVC-Planter Box /w Craftsman Edge Top - 12" x 12" x 12"
PPFL-CFMNTP-16	Flower -PVC-Planter Box /w Craftsman Edge Top - 16" x 16" x 16"
PPFL-CFMNTP-18	Flower -PVC-Planter Box /w Craftsman Edge Top - 18" x 18" x 18"
PPFL-CFMNTP-22	Flower -PVC-Planter Box /w Craftsman Edge Top - 22" x 22" x 22"
PPFL-CFMNTP-28	Flower -PVC-Planter Box /w Craftsman Edge Top - 28" x 28" x 28"

	\$ 55.50	\$ 72.16
	\$ 106.54	\$ 138.50
	\$ 116.02	\$ 150.83
	\$ 138.33	\$ 179.83
	\$ 202.84	\$ 263.68



#2

PPFL-SHNGCB-18	Flower -PVC-Planter Box /w Shingle Cap & Base - 18" x 18" x 18"
PPFL-SHNGCB-22	Flower -PVC-Planter Box /w Shingle Cap & Base - 22" x 22" x 22"
PPFL-SHNGCB-28	Flower -PVC-Planter Box /w Shingle Cap & Base - 28" x 28" x 28"
PPFL-SHNGCB-1836	Flower -PVC-Planter Box /w Shingle Cap & Base - 18" x 18" x 36"
PPFL-SHNGCB-1848	Flower -PVC-Planter Box /w Shingle Cap & Base - 18" x 18" x 48"
PPFL-SHNGCB-1860	Flower -PVC-Planter Box /w Shingle Cap & Base - 18" x 18" x 60"

	\$ 149.73	\$ 194.65
	\$ 190.25	\$ 247.33
	\$ 302.12	\$ 392.76
	\$ 253.97	\$ 330.16
	\$ 311.91	\$ 405.48
	\$ 362.65	\$ 471.45



#3

PPFL-RSSHNG-18	Flower -PVC- Recessed Square Edge Planter Box /w Shingle Mould Cap/w Trim & Base - 18" x 18" x 18"
PPFL-RSSHNG-22	Flower -PVC- Recessed Square Edge Planter Box /w Shingle Mould Cap/w Trim & Base - 22" x 22" x 22"
PPFL-RSSHNG-2236	Flower -PVC- Recessed Square Edge Planter Box /w Shingle Mould Cap/w Trim & Base - 22" x 22" x 36"
PPFL-RSSHNG-2248	Flower -PVC- Recessed Square Edge Planter Box /w Shingle Mould Cap/w Trim & Base - 22" x 22" x 48"
PPFL-RSSHNG-2260	Flower -PVC- Recessed Square Edge Planter Box /w Shingle Mould Cap/w Trim & Base - 22" x 22" x 60"

	\$ 202.74	\$ 263.57
	\$ 248.72	\$ 323.34
	\$ 357.42	\$ 464.65
	\$ 424.20	\$ 551.45
	\$ 489.13	\$ 635.87



#4

PPFL-RSX-18	Flower -PVC- Planter Box /w Applied "X" - 18" x 18" x 18"
PPFL-RSX-22	Flower -PVC- Planter Box /w Applied "X" - 22" x 22" x 22"
PPFL-RSX-2236	Flower -PVC- Planter Box /w Applied "X" - 22" x 22" x 36"
PPFL-RSX-2248	Flower -PVC- Planter Box /w Applied "X" - 22" x 22" x 48"
PPFL-RSX-2260	Flower -PVC- Planter Box /w Applied "X" - 22" x 22" x 60"

	\$ 220.10	\$ 286.13
	\$ 272.59	\$ 354.36
	\$ 373.41	\$ 485.43
	\$ 459.86	\$ 597.81
	\$ 546.28	\$ 710.16

PLAIN PLANTERS



PPF1BD	Planter-PVC-Floor-Plain Panel - 12"W x 17"H
PPF1AE	Planter-PVC-Floor-Plain Panel - 11"W x 19"H

	\$ 79.26	\$ 103.04
	\$ 78.66	\$ 102.26

RAISED PANEL PLANTERS

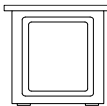

PPF3BD	Planter-PVC-Floor-Raised Panel - 12"W x 17"H
PPF3AE	Planter-PVC-Floor-Raised Panel - 11"W x 19"H

	\$ 102.22	\$ 132.89
	\$ 101.66	\$ 132.16

PLANTER STANDS

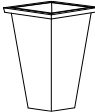

PPS913(42)	Planter-PVC-Stand - 9" - 13" x 42" Tapered
PPS913(60)	Planter-PVC-Stand - 9" - 13" x 60" Tapered
PPST	PVC Cocktail Table Square Top - 1/2" x 18 3/4" x 18 3/4"
PPSO	PVC Cocktail Table Oval Top - 1/2" x 23" x 35"
PPSR	PVC Cocktail Table Round Top - 1/2" x 23" x 35"

	\$ 219.77	\$ 285.71
	\$ 275.88	\$ 358.65
	\$ 37.08	\$ 48.21
	\$ 54.86	\$ 71.32
	\$ 37.08	\$ 48.21

**\*\*PRICES SUBJECT TO CHANGE WITHOUT NOTICE**





**PRESTIGE PLANTERS - 2017**

PRICE LEVEL
NON-STOCKING



P  
R  
E  
S  
T  
I  
G  
E  
  
C  
O  
R  
N  
I  
C  
E

**12' PRESTIGE CORNICE**

PRODUCT CODE
FB-PSCB-58(0612)
FB-PSCB-58(0812)
FB-PSCB-58(1012)
FB-PSCB-58(1212)
FB-C-38(2.512)

DESCRIPTION
Cornice - PVC, Solid Crown/Base Cap, 5/8" x 6" x 12'
Cornice - PVC, Solid Crown/Base Cap, 5/8" x 8" x 12'
Cornice - PVC, Solid Crown/Base Cap, 5/8" x 10" x 12'
Cornice - PVC, Solid Crown/Base Cap, 5/8" x 12" x 12.
Cornice - PVC, Top Cap, 3/8" x 2 1/2" x 12'

NATURAL FINISH	PRE-FINISHED
\$ 88.19	\$ 110.24
\$ 117.56	\$ 146.96
\$ 132.61	\$ 165.77
\$ 147.76	\$ 184.69
\$ 13.01	\$ 16.25

**16' PRESTIGE CORNICE**

FB-PSCB-58(0616)
FB-PSCB-58(0816)
FB-PSCB-58(1016)
FB-PSCB-58(1216)
FB-C-38(2.516)

Cornice - PVC, Solid Crown/Base Cap, 5/8" x 6" x 16'
Cornice - PVC, Solid Crown/Base Cap, 5/8" x 8" x 16'
Cornice - PVC, Solid Crown/Base Cap, 5/8" x 10" x 16'
Cornice - PVC, Solid Crown/Base Cap, 5/8" x 12" x 16'
Cornice - PVC, Top Cap, 3/8" x 2 1/2" x 16'

\$ 117.58	\$ 146.97
\$ 156.75	\$ 195.94
\$ 176.82	\$ 221.02
\$ 197.01	\$ 246.26
\$ 17.34	\$ 21.67

**4' PRESTIGE "EASY FIT" CORNICE**

FB-PSCB(e)-58(0604)
FB-PSCB(e)-58(0804)
FB-PSCB(e)-58(1004)
FB-PSCB(e)-58(1204)
FB-C-38(2.504)

Cornice "Easy Fit" - PVC, Solid Crown/Base Cap, 5/8" x 6" x 4'
Cornice "Easy Fit" - PVC, Solid Crown/Base Cap, 5/8" x 8" x 4'
Cornice "Easy Fit" - PVC, Solid Crown/Base Cap, 5/8" x 10" x 4'
Cornice "Easy Fit" - PVC, Solid Crown/Base Cap, 5/8" x 12" x 4'
Decor Cornice - PVC, Top Cap, 3/8" x 2 1/2" x 4'

\$ 35.27	\$ 44.09
\$ 47.02	\$ 58.78
\$ 53.04	\$ 66.31
\$ 59.10	\$ 73.88
\$ 5.21	\$ 6.50

**8' PRESTIGE "EASY FIT" CORNICE**

FB-PSCB-58(0608)
FB-PSCB(e)-58(0808)
FB-PSCB(e)-58(1008)
FB-PSCB(e)-58(1208)
FB-C-38(2.508)













Cornice - PVC, Solid Crown/Base Cap, 5/8" x 6" x 8'
Cornice "Easy Fit" - PVC, Solid Crown/Base Cap, 5/8" x 8" x 8'
Cornice "Easy Fit" - PVC, Solid Crown/Base Cap, 5/8" x 10" x 8'
Cornice "Easy Fit" - PVC, Solid Crown/Base Cap, 5/8" x 12" x 8'
Decor Cornice - PVC, Top Cap, 3/8" x 2 1/2" x 8'

\$ 70.55	\$ 88.19
\$ 94.05	\$ 117.56
\$ 106.10	\$ 132.61
\$ 118.21	\$ 147.76
\$ 10.40	\$ 13.01

**\*\*PRICES SUBJECT TO CHANGE WITHOUT NOTICE**

PRESTIGE BRACKETS - 2017

P  
R  
E  
S  
T  
I  
G  
E  
  
B  
R  
A  
C  
K  
E  
T  
S

PRODUCT CODE	DESCRIPTION	STANDARD PACKAGE
 GBP-2411-1 GBP-2411-2	PVC - Bracket - 16" x 8" x 3" PVC - Bracket - 18" x 8" x 3"	\$ 82.80 \$ 84.68 \$ - \$ -
 GBP-2480-1 GBP-2480-2	PVC - Bracket - 23 1/2" x 23 1/2" x 4" PVC - Bracket - 33" x 29" x 5"	\$ 94.28 \$ 96.20 \$ - \$ -
 GBP-2520	PVC - Bracket - 39" x 37" x 5 1/2"	\$ 171.82 \$ - \$ - \$ -
 GBP-2558-1 GBP-2558-2	PVC - Bracket - 15" x 13" x 4" PVC - Bracket - 23" x 19" x 4"	\$ 92.30 \$ 109.07 \$ - \$ -
 GBP-2567-1 GBP-2567-2 GBP-2567-1-S GBP-2567-2-S	PVC - Bracket - 32" x 40" x 5" PVC - Bracket - 24" x 34" x 5" PVC - Bracket - 32" x 40" x 5" /w Structural Metal Support PVC - Bracket - 24" x 34" x 5" /w Structural Metal Support	\$ 266.59 \$ 220.70 \$ 372.19 \$ 326.30
 GBP-2588 GBP-2588-2 GBP-2588-3	PVC - Bracket - 9"P x 5"H x 2 3/4"W PVC - Bracket - 24"P x 5"H x 5"W PVC - Bracket - 40"P x 5"H x 5"W	\$ 40.54 \$ 188.71 \$ 314.51 \$ -
 GBP-2614-1 GBP-2614-2	PVC - Bracket - 18" x 16" x 5" PVC - Bracket - 33" x 29" x 5"	\$ 101.04 \$ 143.20 \$ - \$ -
 GBP-2701	PVC - Bracket - 22" x 22" x 3 1/2"	\$ 95.74 \$ - \$ - \$ -
 GBP-2832	PVC - Bracket - 30" x 60" x 7 1/4"	\$ 224.23 \$ - \$ - \$ -
 GBP-2948-1 GBP-2948-2 GBP-2948-1-S GBP-2948-2-S	PVC - Bracket - 32" x 40" x 5" PVC - Bracket - 24" x 34" x 5" PVC - Bracket - 32" x 40" x 5" /w Structural Metal Support PVC - Bracket - 24" x 34" x 5" /w Structural Metal Support	\$ 266.59 \$ 220.70 \$ 372.19 \$ 326.30
 GBP-5400	Bracket-PVC, Stepped Bracket /w Coved Steps & Full Round Detail 5"W x 12 1/4"P x 27 1/4"H	\$ 319.39 \$ - \$ - \$ -
 GBP-5500	Bracket-PVC, Porch Bracket /w Scroll Detail 12" x 12"	\$ 58.09 \$ - \$ - \$ -
 GBP-5600 GBP-5610 GBP-5620	PVC - Bracket - 14" x 14" x 4" PVC - Bracket - 20" x 20" x 4" PVC - Bracket - 24" x 24" x 5 1/2"	\$ 74.30 \$ 88.14 \$ 96.78 \$ -

P  
R  
E  
S  
T  
I  
G  
E  
  
B  
R  
A  
C  
K  
E  
T  
S



GBP-2650

Bracket - PVC, 24"h x 21"p x 6"w- Top Closed

\$ 171.17  
\$ -  
\$ -  
\$ -



GBP-5800

PVC - Bracket - 13 1/2" x 13 1/2" x 3"

\$ 89.17  
\$ -  
\$ -  
\$ -



GBP-5900

PVC - Bracket - 31" x 19" x 4"

\$ 175.44  
\$ -  
\$ -  
\$ -



GBP-6000

PVC - Bracket - 15" x 15" x 6"

\$ 68.24  
\$ -  
\$ -  
\$ -



GBP-6100

PVC - Bracket - 15 3/4" x 10 3/4" x 4"

\$ 76.76  
\$ -  
\$ -  
\$ -



GBP-6200

PVC - Bracket - 22" x 14" x 4"

\$ 89.25  
\$ -  
\$ -  
\$ -



GBP-6300

PVC - Bracket - 11 1/2" x 11 1/2" x 3"

\$ 76.40  
\$ -  
\$ -  
\$ -



GBP-6400

PVC - Bracket - 15 1/2" x 15 1/2" x 5 1/4"

\$ 83.36  
\$ -  
\$ -  
\$ -

\*\*PRICES SUBJECT TO CHANGE WITHOUT NOTICE