



2018 Canwel Price Book

Prestige DIY Products are perhaps the finest PVC systems available for your home.

Constructed from premium quality PVC, these products have been beautifully designed and are *engineered to last.*

Prestige DIY Products™ offer the *elegant beauty* of traditional wood features, while being *virtually maintenance-free*. With the Prestige Advantage, you can expect to enjoy your product for as long as you own your home.

The Prestige Products™ Advantage

Beautiful

- Classic Architectural Look
- No Visible Fasteners
- Wide Assortment of Styles

Easy Installation

- Complete Kit, with Fasteners & Adhesive
- No Special Tools Needed
- Easy Innovative SmartLock™ Corners
- Flat-Pack for Safe & Easy Transportation

Virtually Maintenance Free

- Free-Foam Cellular PVC Construction
- Weather, Decay and Insect Resistant
- Paint Friendly with Acrylic Latex Paints



www.prestigediy.com



PRESTIGE DIY PRODUCTS PRICES - 2018



PREMIUM
COLUMN STYLES

S
Q
U
A
R
E

- [PLAIN COLUMNS](#)
- [RAISED PANEL COLUMNS](#)
- [FLUTED PANEL COLUMNS](#)
- [RECESSED SQUARE EDGE COLUMNS](#)
- [RECESSED FLUSH TRIM COLUMNS](#)
- [RECESSED RAISED TRIM COLUMNS](#)
- [CAP & BASE OPTIONS](#)
- [CONFIRMATION DRAWING](#)

[FLEX COLUMNS](#)

T
A
P
E
R
E
D

- [PLAIN COLUMNS](#)
- [RAISED PANEL COLUMNS](#)
- [RECESSED SQUARE EDGE COLUMNS](#)
- [RECESSED FLUSH TRIM COLUMNS](#)
- [CAP & BASE OPTIONS](#)
- [CONFIRMATION DRAWING](#)

P
R
E
M
I
U
M

- [UNIQUE FLARE](#)
- [COCHREN FLARE \(12" SINGLE LATTICE\)](#)
- [COCHREN FLARE \(16" SINGLE LATTICE\)](#)
- [COCHREN FLARE \(24" SINGLE LATTICE\)](#)
- [COCHREN FLARE \(12" DOUBLE LATTICE\)](#)
- [COCHREN FLARE \(16" DOUBLE LATTICE\)](#)
- [COCHREN FLARE \(24" DOUBLE LATTICE\)](#)
- [CONTEMPORARY FLARE](#)
- [PREMIUM PREVIEW](#)
- [PREMIUM STYLES](#)



G
A
B
L
E
S

- [IT STANDARD GABLES](#)
- [IC STANDARD GABLES](#)
- [GABLE BUILDER / COMING SOON](#)
- [GINGERBREADS](#)



L
O
U
V
R
E
S

- [CLOSED LOUVRE PREVIEW](#)
- [CLOSED LOUVRE](#)



S
H
U
T
T
E
R
S

- [DECOR COLLECTION SHUTTERS](#)
- [DISTINCTIVE COLLECTION SHUTTERS](#)
- [FLEX SHUTTERS](#)
- [SHUTTER HARDWARE](#)
- [SHUTTER POLICY](#)
- [SHUTTER BROCHURE](#)



N
E
W
A
L
S

- [PRESTIGE NEWAL POSTS](#)
- [PRESTIGE PLINTH BOXES](#)



S
O
F
F
I
T

- [PRESTIGE SOFFIT](#)



B
R
A
C
K
E
T
S

- [PRESTIGE BRACKETS](#)



P
L
A
N
T
E
R
S

- [PRESTIGE PLANTERS](#)



C
O
R
N
I
C
E

- [PRESTIGE CORNICE](#)



L
I
N
K
S

- [PRESTIGE COLUMNS INSTALLATION](#)
- [PRESTIGE GABLES ASSEMBLY](#)
- [PRESTIGE GABLES INSTALLATION](#)
- [PAINT OPTIONS](#)
- [PAINT SPECS](#)
- [PRESTIGE WARRANTY](#)





LIMITED WARRANTY - PRESTIGE DIY PRODUCTS™

1357042 Ontario Limited (hereinafter "Décor Innovations") warrants to the original consumer purchaser (the "Original Consumer Purchaser") and only to the extent set forth below, its successor and assign (together with the Original Consumer Purchaser, the "Consumer Purchaser"), subject to the terms and conditions herein, that each PRESTIGE DIY PRODUCTS™ Product, as shipped, will be free from manufacturing defects that cause the Product to delaminate, decay, rot, corrode or swell excessively from moisture for a period of thirty (30) years from the date of the original purchase from an authorized PRESTIGE DIY PRODUCTS™ dealer (the "Original Purchase Date"). Each Consumer Purchaser of PRESTIGE DIY PRODUCTS™ shall have sole responsibility for making determinations as to the suitability, effectiveness, and safety of any particular use or application of the PRESTIGE DIY PRODUCTS™. As building code regulations may vary from area to area, each Consumer Purchaser should consult local building and safety codes for specific requirements.

Value added paint options come with a 1 year limited warranty.

ADDITIONAL CONDITIONS AND EXCEPTIONS

In all events, Décor Innovation's sole and exclusive liabilities under this warranty are limited solely and exclusively to replacement of defective PRESTIGE DIY PRODUCTS™, or the issuance of a refund equal to the original cost of the PRESTIGE DIY PRODUCTS™. Under no circumstances shall Décor Innovations be liable for labour, installation, reinstallation, freight, taxes or any other charge related to defective PRESTIGE DIY PRODUCTS™. Décor Innovations shall not be liable under any circumstances for any indirect, incidental, punitive, consequential, exemplary or other damages of any kind whatsoever, whether any such claim is based upon theories of contract, warranty, negligence, tort strict liability or otherwise. This warranty does not provide protection against any failure of, defect in or damage to PRESTIGE DIY PRODUCTS™ caused by situations beyond normal exposure conditions, including but not limited to the following: intentional or unintentional misuse, abuse, neglect, or improper handling or storage; impact of foreign objects; earthquake, lightning, ice, fire, tornado, windstorm, flood, among others or any other acts of God; improper installation of the PRESTIGE DIY PRODUCTS™ or its structural supports, or installation not in strict adherence to Décor Innovation's written instructions; cracking, distortion, movement, settlement, or warping of the PRESTIGE DIY PRODUCTS™ structural supports or accessories used in connection therewith; insurrection, terrorism, acts of war, riot, vandalism, improper maintenance, use of incompatible accessories; or other products that cause a PRESTIGE DIY PRODUCTS™ defect or failure to occur; pollution, acid rain, contact with harmful chemicals or vapors; or ordinary and expected weathering due to exposure to the elements; which for purposes of this Warranty is defined to be fading, chalking or darkening of the surface of the Product due to exposure to natural sunlight and extreme atmospheric conditions that are unique to and may vary depending on geographic location. Décor Innovations shall have sole discretion to determine, based on reasonable criteria, whether the PRESTIGE DIY PRODUCTS™ is suffering from normal weathering. This Warranty does not cover painted finishes or coating applied to PRESTIGE DIY PRODUCTS™ by the Consumer Purchaser or any third party. Failure to adhere to Décor Innovation's recommended guidelines for application of painted surfaces shall void this Warranty. All claims under this Limited Warranty must be made within 90 days from the time that the defect is discovered and while the PRESTIGE DIY PRODUCTS™ is in place. Consumer Purchaser shall provide Décor Innovations and its agents and employees with a reasonable opportunity to inspect and test the PRESTIGE DIY PRODUCTS™, its installation, and the environment in which the Consumer Purchaser used it prior to removal so that Décor Innovations may determine what replacement, if any, may be needed. In the event that Décor Innovations determines that a replacement is appropriate, Décor Innovations shall have the option of retaining all material that is replaced. If Décor Innovations replaces any material under this warranty, it may substitute products designed by Décor Innovations to be of compatible quality or price range in the event that the product initially purchased has been discontinued or modified. Anything less than strict compliance with these notice and inspection provisions shall serve to void all warranties with regard to PRESTIGE DIY PRODUCTS™. This Warranty may not be altered or amended except in a written statement signed Décor Innovations and Consumer Purchaser. Décor Innovations has not authorized any dealer or other person to make statements or representations regarding the performance of PRESTIGE DIY PRODUCTS™ except as contained in this Warranty, and Décor Innovations shall not be bound by any such statements other than those contained herein.

THE FOREGOING WARRANTY IS EXCLUSIVE AND IN LIEU OF ANY AND ALL OTHER APPLICABLE WARRANTIES, EXPRESS OR IMPLIED, INCLUDING WITHOUT LIMITATION, ANY IMPLIED WARRANTY OF MERCHANTABILITY OR FITNESS FOR A PARTICULAR USE.

This Warranty is transferable to a successor by the Original Consumer Purchaser with the transfer of other conveyance of the PRESTIGE DIY PRODUCTS™ and shall not be transferable or assignable by any subsequent consumer purchaser. In accordance with the foregoing, this Warranty shall expire upon the first to occur of: (i) the transfer or other conveyance of the PRESTIGE DIY PRODUCTS™ by the Original Consumer Purchaser's successor or assign; or (ii) thirty (30) years from the Original Purchase Date.

Some states and provinces do not permit limitations on the duration of implied warranties or exclusions or limitations of incidental or consequential damages, so certain limitations set forth in this Limited Warranty may not apply to you. This warranty gives you specific legal rights, and you may have other rights which may vary from state to state.

FILING A WARRANTY CLAIM

To file a claim under this Warranty, Consumer Purchaser must send proof of purchase, a photograph of the defective PRESTIGE DIY PRODUCTS™ and a written description of the nature of the defect to the company's corporate address in Oakville, ON. (See address below). Décor Innovations reserves the right to investigate any claim hereunder. Upon verification of the claim, Décor Innovations shall, at its sole discretion, either arrange for the delivery of replacement Product or issue a refund equal to the original cost of the Product only. In either instance, Consumer Purchaser shall allow Décor Innovations at least ninety (90) days for investigation and either replacement or refund.

Prestige DIY Products · 423 Wycroft Road, Unit B, Oakville, ON L6K 2H2
Ph. 289-291-9006 · fax. 289-291-7948 · www.prestigediy.com

Stock Colours

EURO FINISH	
LIGHT COLOURS (LRV 56 - 100)	Benjamin Moore Colours
	Jute AF-80
	Mascarpone AF-20
	Gray Sky 2131-70
	Almond Bisque 269
	Ashen Tan 996
Sterling 1591	
Gentek Colours	
Almond (532)	Sandstone (540)
Ice White (429)	Maize (502)
Sandalwood (508)	Pearl (534)
DARK COLOURS (LRV 0 - 55)	Benjamin Moore Colours
	Clay AF-155
	River Rock 2139-10
	Flint AF-560
	Blue HC-159
	Deep Creek 1477
Chelsea Gray HC-168	
Gentek Colours	
Pebble (559)	Commercial Brown (562)
Midnight Surf (509)	Wedgewood Blue (535)
Sable (547)	Storm (570)

*** Custom Colours & Stains**
 Custom surcharge will apply
 Speak with your PrestigeDIY Representative for more information.

Stock Paint: 30% Surcharge on Material Value

Dark Colours
 * Dark Colour Paints have heat reflective qualities.

Standard **EURO FINISH** on all dark painted products.

Stock Stains



Cherry
DD#9571



Teak
DD#9512



Espresso
DD#9575



Mahogany
DD#9509

Stain Finishes on Prestige DIY Products!

Stock Stain: 45% Surcharge on Material Value with Top Clear Coat



Note: Colours may vary from above chart. All colours to be signed off on before production.

5 Year Limited Paint Warranty.

For further information please visit us at prestigedi.com

Preparation & Application

Your Prestige DIY Products™ is manufactured using premium free-foam cellular PVC and does not require painting to validate the warranty. If painting is preferred please use the guidelines below.

Surface Preparation

Prestige DIY Products™ can be painted to achieve the desired look or accent colour of your home. To ensure good paint adhesion, the surface of the pvc product should be clean, dry, and free of dirt, mildew, chalk, grease and any other surface contaminants before paint application. Prior to cleaning it is a good practice to fill any holes and remove any marks or blemishes that may appear during the installation process with an exterior filler, (for example, sandable Bondo).

Cleaning can be accomplished using a cloth and a mixture of mild detergent and water. Other cleaning agents include a mild household spray cleaner, a degreaser, or alcohol.

Coating Specification

A 100% acrylic latex or 100% acrylic latex with a urethane additive should be used to achieve superior coating durability and flexibility. Only light to medium coloured paints with a light reflective value (LRV) of 55 units or greater should be applied to Prestige DIY Products™. *Using a paint with a LRV below 55 units will void our product warranty.*

Paint manufacturer recommendations include priming with an exterior 100% acrylic latex primer, followed by two coats of exterior 100% acrylic latex satin finish paint.

Application

Apply paint when the air and surface temperatures are 2°C (35°F) or above, and when the air and surface temperatures will remain above this temperature for the next 24 hours. Avoid painting early in the morning or late in the day when dew and condensation are likely to form, or when rain or snow is threatening. To prolong the shelf life of the paint, always protect it from freezing.

Apply primer and topcoats using the following methods:

- Brush: Use a nylon/polyester brush.
- Roller: Use a 3/8" – 3/4" nap synthetic roller.
- Spray: Airless Pressure...2000 psi Tip...015"-019"

Typical Drying Times (Dry Time at 25°C (77°F); 50% Relative Humidity.):

- To the Touch: 30 minutes - To Recoat: 4 hours
- To Handle: 1 hour - To Full Cure: 30 days

Considerations

- Higher quality paints typically outperform lower quality paints.
- Temperature, humidity, wind, and the amount of direct sunlight at time of application will affect paint drying times.
- Prestige Products™ are impermeable to moisture; it may take as long as 45 days for paint application to fully cure.
- Paint failures on wood are due primarily to moisture cycling. Since Prestige Products™ cannot absorb moisture, paints will adhere better and for a much longer time when applied to premium PVC versus wood.

Disclaimer: Decor Innovations is not liable for paint used on Prestige DIY Products™ and/or the result of its use.



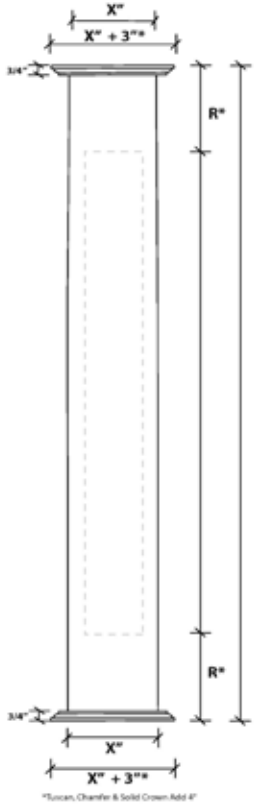

*Tuscan, Chamfer & Solid Crown Add 4"

**Note: For more column dimension information see Prestige Columns Reference Guide (2in Reverse). Customers are responsible for confirming inside dimensions prior to ordering. Please consult your Prestige Products representative when ordering. All approved custom column orders are non-refundable.

CUSTOM STRAIGHT COLUMN LAYOUT

CLIENT INFORMATION		PANEL SIZES	
Dealer Name: _____		1. Height (Y") _____	
Project: _____		2. Width (X") _____	
PO#: _____		<input type="checkbox"/> Nominal <input type="checkbox"/> Actual	
Project Contact: _____		3. Inside Dims _____	
Date: _____		4. Painted <input type="checkbox"/> No <input type="checkbox"/> Yes	
Approved By: _____		Colour: _____	

PANEL PROFILE		NOTES:
1. Plain 2. Fluted 3. Raised 4. Recessed - Square Edge - Round Edge - w/ Base Cap Trim - Flush Trim - Raised Trim	<input type="checkbox"/> Single Panel <input type="checkbox"/> Double Panel <input type="checkbox"/> 1/3 - 2/3 Panel <input type="checkbox"/> Custom _____	Panel Locks: <input type="checkbox"/> M <input type="checkbox"/> F

CAPS & BASES	
Craftsman 4" 6" 8" 10"	Chamfered 4" 6" 8" 10"
Crown Mould 4" 5" 6"	Base Cap Edge 4" 6" 8" 10"
Tuscan 5" 6" 8" 10"	Solid Crown 1. 2.



Prestige Column Sizes & Reveals - Straight Columns

Product Code	Prestige PVC Square Columns	Outside Dims. (inches)	Inside Dims. (inches)	Column Weight (lbs)
CPSP-0805-096	Prestige Columns - PVC, Square, Plain Panel, 8" x 8" x 6"	37" (11/4")	6 1/4"	40
CPSP-0805-120	Prestige Columns - PVC, Square, Plain Panel, 8" x 8" x 10"	37" (11/4")	6 1/4"	49
CPSP-1200-096	Prestige Columns - PVC, Square, Plain Panel, 10" x 10" x 6"	12" (19 3/8")	8 3/8"	49
CPSP-0805-096	Prestige Columns - PVC, Square, Flared Panel, 8" x 8" x 6"	37" (11/4")	6 1/4"	40
CPSP-0805-120	Prestige Columns - PVC, Square, Flared Panel, 8" x 8" x 10"	37" (11/4")	6 1/4"	49
CPSP-1200-096	Prestige Columns - PVC, Square, Flared Panel, 10" x 10" x 6"	12" (19 3/8")	8 3/8"	49
CPSP-0805-096	Prestige Columns - PVC, Square, Raised Panel, 8" x 8" x 6"	37" (11/4")	6 1/4"	40
CPSP-0805-120	Prestige Columns - PVC, Square, Raised Panel, 8" x 8" x 10"	37" (11/4")	6 1/4"	49
CPSP-1200-096	Prestige Columns - PVC, Square, Raised Panel, 10" x 10" x 6"	12" (19 3/8")	8 3/8"	49
CPSP-0805-096	Prestige Columns - PVC, Square, Recessed Panel - Square Edge, 8" x 8" x 6"	37" (11/4")	5 1/4"	40
CPSP-0805-120	Prestige Columns - PVC, Square, Recessed Panel - Square Edge, 8" x 8" x 10"	37" (11/4")	5 1/4"	49
CPSP-1200-096	Prestige Columns - PVC, Square, Recessed Panel - Square Edge, 10" x 10" x 6"	12" (19 3/8")	7 3/8"	49
CPSP-0805-096	Prestige Columns - PVC, Square, Recessed Panel Flush Trim - Base Cap Edge, 8" x 8" x 6"	37" (11/4")	5 1/4"	41
CPSP-0805-120	Prestige Columns - PVC, Square, Recessed Panel Flush Trim - Base Cap Edge, 8" x 8" x 10"	37" (11/4")	5 1/4"	52
CPSP-1200-096	Prestige Columns - PVC, Square, Recessed Panel Flush Trim - Base Cap Edge, 10" x 10" x 6"	12" (19 3/8")	7 3/8"	52
CPSP-0805-096	Prestige Columns - PVC, Square, Recessed Panel Raised Trim - Base Cap Edge, 8" x 8" x 6"	37" (11/4")	5 1/4"	41
CPSP-0805-120	Prestige Columns - PVC, Square, Recessed Panel Raised Trim - Base Cap Edge, 8" x 8" x 10"	37" (11/4")	5 1/4"	52
CPSP-1200-096	Prestige Columns - PVC, Square, Recessed Panel Raised Trim - Base Cap Edge, 10" x 10" x 6"	12" (19 3/8")	7 3/8"	52

NOTE: * Wall Req: Around 6" x 6" PT Wood Studs
 Packaging: Standard kit consists of boxes, 4 column panels, cap/base with adhesive strip, squaring corners, 2 oz. adhesive, fasteners, instructions.

Prestige Panel Styles	Column Width (")	Outside Dims (")	Inside Dims (")	Recessed Backer Cap*
Plain Panel Fluted Panel Raised Panel Recessed Panel Recessed Panel with Trim	6 8 10 12 14 16 18 20 22 24	5-3/2" 7-1/4" 9-3/8" 11-1/4" 13-1/4" 15-1/4" 17-1/4" 19-1/4" 21-1/4" 23-1/4"	4-1/2" 6-1/4" 8-3/8" 10" 12" 14" 16" 18" 20" 22"	3-3/2" 5-1/4" 7-3/8" 9" 11" 13" 15" 17" 19" 21"



*NOTE:
 -For any column skirts above 6" in height, the column reveals will go to 14".
 -6" - 10" columns with square edge recessed panels will use either a 3/8" or a 1/2" thick backer panel.
 -12" columns and larger, with square edge recessed panels, will use a 1/2" thick backer panel.
 -All columns with recessed panel with base cap trim will use a 5/8" thick column skirt and backer panel.



P R E M I U M
C O L U M N S T Y L E S



Cochren Flare I

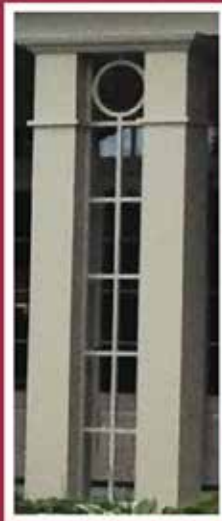

Cochren Flare II



Bayside I



Bayview I



Edgewater I



Riverside I



Unique Flare I



Blue Water I



Lakeside I



Bayshore II



Contemporary
Flare I



Contemporary
Flare II

www.prestigedi.com

PRESTIGE PREMIUM COLUMNS - 2018

PRESTIGE PREMIUM	PRODUCT CODE	DESCRIPTION	STANDARD PACKAGE	
	BAYSHORE II	CPSRS2-08096-BY CPSRS2-10096-BY CPSRS2-12120-BY	Column - PVC, Square Edge, Double Recessed Panel, 8" @ 8' /w 4" Craftsman Cap & 8" Craftsman Base Column - PVC, Square Edge, Double Recessed Panel, 10" @ 8' /w 4" Craftsman Cap & 8" Craftsman Base Column - PVC, Square Edge, Double Recessed Panel, 12" @ 10' /w 4" Craftsman Skirt & 8" Craftsman Base	\$ 306.74 \$ 366.95 \$ 484.67
	LAKESIDE I	CPSRBF4-08096-LK CPSRBF4-10096-LK CPSRBF4-12120-LK	Column - PVC, Square, Recessed Flush Trim Panel - 50/50, 8" @ 8' /w 4" Craftsman Skirts Column - PVC, Square, Recessed Flush Trim Panel - 50/50, 10" @ 8' /w 4" Craftsman Skirts Column - PVC, Square, Recessed Flush Trim Panel - 50/50, 12" @ 10' /w 4" Craftsman Skirts	\$ 413.54 \$ 459.05 \$ 588.14
	BAYSIDE I	CPSRBF1-08096-BS CPSRBF1-10096-BS CPSRBF1-12120-BS	Column - PVC, Square, Recessed Flush Trim Single Panel, 8" @ 8' /w 4" Craftsman Skirts Column - PVC, Square, Recessed Flush Trim Single Panel, 10" @ 8' /w 4" Craftsman Skirts Column - PVC, Square, Recessed Flush Trim Single Panel, 12" @ 10' /w 4" Craftsman Skirts	\$ 379.00 \$ 420.67 \$ 538.31
	RIVERSIDE I	CPSRBF3-08096-RV CPSRBF3-10096-RV CPSRBF3-12120-RV	Column - PVC, Square, Recessed Flush Trim Panel - 1/2 - 2/3, 8" @ 8' /w 5" Crown Cap, 8" Base Cap Skirt & Base Cap Astragal Column - PVC, Square, Recessed Flush Trim Panel - 1/2 - 2/3, 10" @ 8' /w 5" Crown Cap, 8" Base Cap Skirt & Base Cap Astragal Column - PVC, Square, Recessed Flush Trim Panel - 1/2 - 2/3, 12" @ 10' /w 5" Crown Cap, 8" Base Cap Skirt & Base Cap Astragal	\$ 493.64 \$ 549.34 \$ 688.64
	EDGEWATER I	CPSRBF1-08096-EW CPSRBF1-10096-EW CPSRBF1-12120-EW	Column - PVC, Square, Recessed Flush Trim Single Panel, 8" @ 8' /w 6" Crown Cap, 5" PVC Tuscan Skirt & Base Cap Astragal Column - PVC, Square, Recessed Flush Trim Single Panel, 10" @ 8' /w 6" Crown Cap, 5" PVC Tuscan Skirt & Base Cap Astragal Column - PVC, Square, Recessed Flush Trim Single Panel, 12" @ 10' /w 6" Crown Cap, 5" PVC Tuscan Skirt & Base Cap Astragal	\$ 441.61 \$ 487.08 \$ 608.56
	BAYVIEW I	CPSRBF1-08096-BV CPSRBF1-10096-BV CPSRBF1-12120-BV	Column - PVC, Square, Recessed Flush Trim Single Panel, 8" @ 8' /w 5" Crown Cap, 8" Base Cap Skirt & Base Cap Astragal Column - PVC, Square, Recessed Flush Trim Single Panel, 10" @ 8' /w 5" Crown Cap, 8" Base Cap Skirt & Base Cap Astragal Column - PVC, Square, Recessed Flush Trim Single Panel, 12" @ 10' /w 5" Crown Cap, 8" Base Cap Skirt & Base Cap Astragal	\$ 459.11 \$ 510.96 \$ 638.81
	COCHREN FLARE I	CPSPLDC12-08096-CF1 CPSPLDC12-10096-CF1 CPSPLDC12-12120-CF1	Column - PVC, Square, Plain Panel /w Double 12" Lattice, 8" @ 8' /w 5" Crown Mould Cap, 5" PVC Tuscan Base & 1" Astragal Column - PVC, Square, Plain Panel /w Double 12" Lattice, 10" @ 8' /w 5" Crown Mould Cap, 5" PVC Tuscan Base & 1" Astragal Column - PVC, Square, Plain Panel /w Double 12" Lattice, 12" @ 10' /w 5" Crown Mould Cap, 5" PVC Tuscan Base & 1" Astragal	\$ 1,118.89 \$ 1,225.50 \$ 1,579.49
	COCHREN FLARE II	CPSPLS12-08096-CF2 CPSPLS12-10096-CF2 CPSPLS12-12120-CF2	Column - PVC, Square, Plain Panel /w Single 12" Lattice, 8" @ 8' /w 5" Crown Mould Cap, 5" PVC Tuscan Base & 1" Astragal Column - PVC, Square, Plain Panel /w Single 12" Lattice, 10" @ 8' /w 5" Crown Mould Cap, 5" PVC Tuscan Base & 1" Astragal Column - PVC, Square, Plain Panel /w Single 12" Lattice, 12" @ 10' /w 5" Crown Mould Cap, 5" PVC Tuscan Base & 1" Astragal	\$ 679.09 \$ 755.66 \$ 970.34
	UNIQUE FLARE	CPSCH-08096-UF CPSCH-10096-UF CPSCH-12120-UF	Column - PVC, Square, Chamfered Plain Panel, 8" @ 8' /w 4/4" x 8" Chamfered Cap & 4/4" x 10" Chamfered Base Column - PVC, Square, Chamfered Plain Panel, 10" @ 8' /w 4/4" x 8" Chamfered Cap & 4/4" x 10" Chamfered Base Column - PVC, Square, Chamfered Plain Panel, 12" @ 10' /w 4/4" x 8" Chamfered Cap & 4/4" x 10" Chamfered Base	\$ 337.40 \$ 409.26 \$ 574.03

DIMS

SIZE	OUTSIDE
6"	5-1/2"
8"	7-1/4"
10"	9-3/8"
12"	11-1/2"
14"	13-1/4"

SQUARING "L" INCLUDED

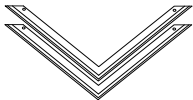

*Adds 3" to Outside Dims

***12% FOR CUSTOM HEIGHT & 12% FOR ACTUAL WIDTH**
*****FOR COLUMNS LARGER THAN 14" PLEASE CONTACT YOUR LOCAL PRESTIGE DEALER**
****PRICES SUBJECT TO CHANGE WITHOUT NOTICE**

PRESTIGE FLEX COLUMNS - 2018

FLEX COLUMNS

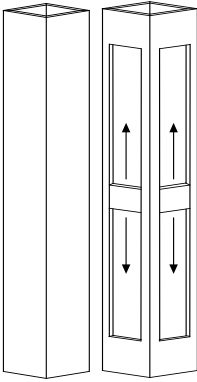

ADJUSTABLE
4" DIVIDER

*Reveals match Standard Column Layouts

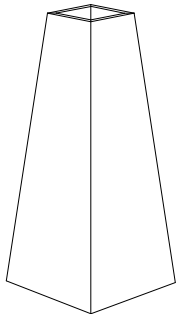

6" SQUARE COLUMNS	PRODUCT CODE	DESCRIPTION	FLEX PACKAGE (1PC)	FLEX PACKAGE (6PCS)	FLEX PACKAGE (24PCS)
	CPSPL-06096-FX	Column - PVC, Square, Plain, 6" @ 8'	\$ 182.10	\$ 145.68	\$ 136.57
	CPSPL-06120-FX	Column - PVC, Square, Plain, 6" @ 10'	\$ 201.31	\$ 161.04	\$ 150.98
	CSP-6FX	Skirt - PVC, Flex Skirt, 1" x 6"ID (1 Set - 4 L's)	\$ 11.86	\$ 11.16	\$ 10.46
8" SQUARE COLUMNS					
	CPSPL-08096-FX	Column - PVC, Square, Plain, 8" @ 8'	\$ 175.29	\$ 164.98	\$ 154.67
	CPSPL-08120-FX	Column - PVC, Square, Plain, 8" @ 10'	\$ 210.89	\$ 198.49	\$ 186.08
	CSP-8FX	Skirt - PVC, Flex Skirt, 1" x 8"ID (1 Set - 4 L's)	\$ 13.50	\$ 12.70	\$ 11.91
10" SQUARE COLUMNS					
	CPSPL-10096-FX	Column - PVC, Square, Plain, 10" @ 8'	\$ 207.91	\$ 195.68	\$ 183.45
	CPSPL-10120-FX	Column - PVC, Square, Plain, 10" @ 10'	\$ 253.79	\$ 238.86	\$ 223.93
	CSP-10FX	Skirt - PVC, Flex Skirt, 1" x 10"ID (1 Set - 4 L's)	\$ 15.13	\$ 14.24	\$ 13.35
8" RECESSED SQUARE EDGE					
	CPSRS-08096-FX	Column - PVC, Square, Recessed Square Edge Panel, 8" @ 8'	\$ 255.42	\$ 240.39	\$ 225.37
	CPSRS-08120-FX	Column - PVC, Square, Recessed Square Edge Panel, 8" @ 10'	\$ 310.48	\$ 292.21	\$ 273.95
	CSP-8FX	Skirt - PVC, Flex Skirt, 1" x 8"ID (1 Set - 4 L's)	\$ 13.50	\$ 12.70	\$ 11.91
10" RECESSED SQUARE EDGE					
	CPSRS-10096-FX	Column - PVC, Square, Recessed Square Edge Panel, 10" @ 8'	\$ 309.55	\$ 291.34	\$ 273.13
	CPSRS-10120-FX	Column - PVC, Square, Recessed Square Edge Panel, 10" @ 10'	\$ 379.86	\$ 357.51	\$ 335.17
	CSP-10FX	Skirt - PVC, Flex Skirt, 1" x 10"ID (1 Set - 4 L's)	\$ 15.13	\$ 14.24	\$ 13.35

12"-8" PLAIN TAPERED	PRODUCT CODE	DESCRIPTION	1 PC	6 PCS	24 PCS
	CPTPL-1208048-FX	Column - PVC, Tapered, Plain Panel, 12"-8" @ 4'	\$ 148.91	\$ 140.15	\$ 131.39
	CPTPL-1208060-FX	Column - PVC, Tapered, Plain Panel, 12"-8" @ 5'	\$ 163.88	\$ 154.24	\$ 144.60
	CPTPL-1208072-FX	Column - PVC, Tapered, Plain Panel, 12"-8" @ 6'	\$ 178.86	\$ 168.34	\$ 157.82
	CPTPL-1208096-FX	Column - PVC, Tapered, Plain Panel, 12"-8" @ 8'	\$ 208.81	\$ 196.52	\$ 184.24
	CPTPL-1208120-FX	Column - PVC, Tapered, Plain Panel, 12"-8" @ 10'	\$ 238.76	\$ 224.72	\$ 210.67
	CPTPL-1208144-FX	Column - PVC, Tapered, Plain Panel, 12"-8" @ 12'	\$ 268.79	\$ 252.97	\$ 237.16
	CSP-1208FX	Skirt - PVC, Flex Skirt, 2 L's @ 1" x 12"ID & 2 L's @ 1" x 8"ID (1 Set)	\$ 15.13	\$ 14.24	\$ 13.35

ADHESIVE	ADHS-WO7052
----------	-------------

Weld On705 WHITE 2 OZ Tube

1 PC	6 PCS	24 PCS
\$ 3.28	\$ 19.67	\$ 78.66

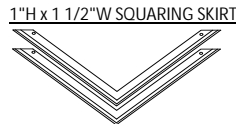

1"H x 1 1/2"W SQUARING SKIRT

*Add 3" to Outside Dims

SQUARE DIMS			TAPERED DIMS		
SIZE	OUTSIDE	INSIDE	SIZE	OUTSIDE	INSIDE
6"	5-1/2"	4-1/2"	12"-8"	12"	8"
8"	7-1/4"	6-1/4"	11"	11"	7"
10"	9-3/8"	8-3/8"	SQUARE RECESSED PANEL DIMS		
SIZE	OUTSIDE	INSIDE	8"	7-1/4"	5-1/4"
			10"	9-3/8"	7-3/8"

****PRICES REFLECT 2 PC SHAFT, PACKAGED IN CLEAR PLASTIC FILM /W EDGE PROTECTORS & BAGGED
SOLD SEPARATELY: Adhesive, Fasteners & Squaring Skirt Sold in 1-6-24 Packs
Square Column Recessed Panel /w 4" Adjustable Divider Set (Micro-Beveled Edges for alignment to Column Shaft)
*PRICES SUBJECT TO CHANGE WITHOUT NOTICE**



Standard C&B: 4" Craftsman	
CAP	4" Craftsman Skirt
BASE	4" Craftsman Skirt
<input checked="" type="checkbox"/> ADD CAP & BASE	

PRESTIGE COLUMNS - 2018

6" COLUMNS	PRODUCT CODE / SHAFT	PRODUCT CODE /w	DESCRIPTION	1 PIECE	6 PIECE
	ONLY	4" SKIRTS			
	CPSPL-06048	CPSPL-06048-4K	Column - PVC, Square, Plain, 6" @ 4'	\$ 180.37	\$ 169.55
	CPSPL-06060	CPSPL-06060-4K	Column - PVC, Square, Plain, 6" @ 5'	\$ 191.04	\$ 179.58
	CPSPL-06072	CPSPL-06072-4K	Column - PVC, Square, Plain, 6" @ 6'	\$ 201.71	\$ 189.61
	CPSPL-06096	CPSPL-06096-4K	Column - PVC, Square, Plain, 6" @ 8'	\$ 223.09	\$ 209.70
	CPSPL-06108	CPSPL-06108-4K	Column - PVC, Square, Plain, 6" @ 9'	\$ 233.77	\$ 219.74
	CPSPL-06120	CPSPL-06120-4K	Column - PVC, Square, Plain, 6" @ 10'	\$ 244.46	\$ 229.80
	CPSPL-06144	CPSPL-06144-4K	Column - PVC, Square, Plain, 6" @ 12'	\$ 265.88	\$ 249.93
8" COLUMNS	CPSPL-08048	CPSPL-08048-4K	Column - PVC, Square, Plain, 8" @ 4'	\$ 192.93	\$ 181.35
	CPSPL-08060	CPSPL-08060-4K	Column - PVC, Square, Plain, 8" @ 5'	\$ 209.22	\$ 196.67
	CPSPL-08072	CPSPL-08072-4K	Column - PVC, Square, Plain, 8" @ 6'	\$ 225.52	\$ 211.99
	CPSPL-08096	CPSPL-08096-4K	Column - PVC, Square, Plain, 8" @ 8'	\$ 258.11	\$ 242.62
	CPSPL-08108	CPSPL-08108-4K	Column - PVC, Square, Plain, 8" @ 9'	\$ 274.41	\$ 257.94
	CPSPL-08120	CPSPL-08120-4K	Column - PVC, Square, Plain, 8" @ 10'	\$ 290.70	\$ 273.26
	CPSPL-08144	CPSPL-08144-4K	Column - PVC, Square, Plain, 8" @ 12'	\$ 323.38	\$ 303.98
10" COLUMNS	CPSPL-10048	CPSPL-10048-4K	Column - PVC, Square, Plain, 10" @ 4'	\$ 213.06	\$ 200.28
	CPSPL-10060	CPSPL-10060-4K	Column - PVC, Square, Plain, 10" @ 5'	\$ 233.43	\$ 219.42
	CPSPL-10072	CPSPL-10072-4K	Column - PVC, Square, Plain, 10" @ 6'	\$ 253.81	\$ 238.58
	CPSPL-10096	CPSPL-10096-4K	Column - PVC, Square, Plain, 10" @ 8'	\$ 294.54	\$ 276.87
	CPSPL-10108	CPSPL-10108-4K	Column - PVC, Square, Plain, 10" @ 9'	\$ 314.91	\$ 296.01
	CPSPL-10120	CPSPL-10120-4K	Column - PVC, Square, Plain, 10" @ 10'	\$ 335.28	\$ 315.16
	CPSPL-10144	CPSPL-10144-4K	Column - PVC, Square, Plain, 10" @ 12'	\$ 376.12	\$ 353.55
12" COLUMNS	CPSPL-12048	CPSPL-12048-4K	Column - PVC, Square, Plain, 12" @ 4'	\$ 233.19	\$ 219.19
	CPSPL-12060	CPSPL-12060-4K	Column - PVC, Square, Plain, 12" @ 5'	\$ 257.63	\$ 242.18
	CPSPL-12072	CPSPL-12072-4K	Column - PVC, Square, Plain, 12" @ 6'	\$ 282.07	\$ 265.15
	CPSPL-12096	CPSPL-12096-4K	Column - PVC, Square, Plain, 12" @ 8'	\$ 330.96	\$ 311.10
	CPSPL-12108	CPSPL-12108-4K	Column - PVC, Square, Plain, 12" @ 9'	\$ 355.40	\$ 334.08
	CPSPL-12120	CPSPL-12120-4K	Column - PVC, Square, Plain, 12" @ 10'	\$ 379.85	\$ 357.06
	CPSPL-12144	CPSPL-12144-4K	Column - PVC, Square, Plain, 12" @ 12'	\$ 428.86	\$ 403.13
14" COLUMNS	CPSPL-14048	CPSPL-14048-4K	Column - PVC, Square, Plain, 14" @ 4'	\$ 254.07	\$ 238.83
	CPSPL-14060	CPSPL-14060-4K	Column - PVC, Square, Plain, 14" @ 5'	\$ 282.59	\$ 265.64
	CPSPL-14072	CPSPL-14072-4K	Column - PVC, Square, Plain, 14" @ 6'	\$ 311.10	\$ 292.44
	CPSPL-14096	CPSPL-14096-4K	Column - PVC, Square, Plain, 14" @ 8'	\$ 368.14	\$ 346.05
	CPSPL-14108	CPSPL-14108-4K	Column - PVC, Square, Plain, 14" @ 9'	\$ 396.65	\$ 372.85
	CPSPL-14120	CPSPL-14120-4K	Column - PVC, Square, Plain, 14" @ 10'	\$ 425.17	\$ 399.66
	CPSPL-14144	CPSPL-14144-4K	Column - PVC, Square, Plain, 14" @ 12'	\$ 482.35	\$ 453.41

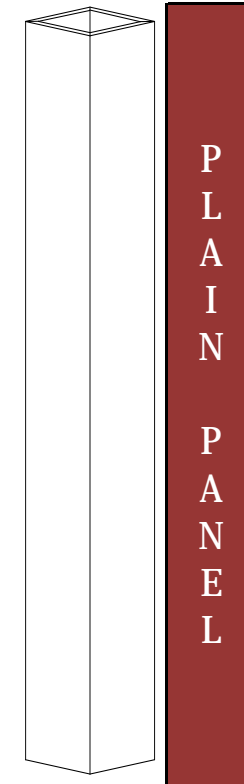

SIZE	DIMS	
	OUTSIDE	INSIDE
6"	5-1/2"	4-1/2"
8"	7-1/4"	6-1/4"
10"	9-3/8"	8-3/8"
12"	11-1/2"	10-1/2"
14"	13-1/4"	12-1/4"



*Add 3" to Outside Dims

*12% FOR CUSTOM HEIGHT & 12% FOR ACTUAL WIDTH
 ***FOR COLUMNS LARGER THAN 14" PLEASE CONTACT YOUR LOCAL PRESTIGE DEALER
 **PRICES SUBJECT TO CHANGE WITHOUT NOTICE



Standard C&B: 4" Craftsman	
CAP	4" Craftsman Skirt
BASE	4" Craftsman Skirt
☑ ADD CAP & BASE	

PRESTIGE COLUMNS - 2018

6" COLUMNS

PRODUCT CODE / SHAFT ONLY	PRODUCT CODE /w 4" SKIRTS	DESCRIPTION	1 PIECE	6 PIECE
CPSRA-06048	CPSRA-06048-4K	Column - PVC, Square, Raised Panel, 6" @ 4'	\$ 206.47	\$ 194.08
CPSRA-06060	CPSRA-06060-4K	Column - PVC, Square, Raised Panel, 6" @ 5'	\$ 218.70	\$ 205.57
CPSRA-06072	CPSRA-06072-4K	Column - PVC, Square, Raised Panel, 6" @ 6'	\$ 230.92	\$ 217.07
CPSRA-06096	CPSRA-06096-4K	Column - PVC, Square, Raised Panel, 6" @ 8'	\$ 255.36	\$ 240.04
CPSRA-06108	CPSRA-06108-4K	Column - PVC, Square, Raised Panel, 6" @ 9'	\$ 267.58	\$ 251.53
CPSRA-06120	CPSRA-06120-4K	Column - PVC, Square, Raised Panel, 6" @ 10'	\$ 279.81	\$ 263.02
CPSRA-06144	CPSRA-06144-4K	Column - PVC, Square, Raised Panel, 6" @ 12'	\$ 304.31	\$ 286.05

8" COLUMNS

CPSRA-08048	CPSRA-08048-4K	Column - PVC, Square, Raised Panel, 8" @ 4'	\$ 227.75	\$ 214.08
CPSRA-08060	CPSRA-08060-4K	Column - PVC, Square, Raised Panel, 8" @ 5'	\$ 244.04	\$ 229.40
CPSRA-08072	CPSRA-08072-4K	Column - PVC, Square, Raised Panel, 8" @ 6'	\$ 260.34	\$ 244.72
CPSRA-08096	CPSRA-08096-4K	Column - PVC, Square, Raised Panel, 8" @ 8'	\$ 292.93	\$ 275.35
CPSRA-08108	CPSRA-08108-4K	Column - PVC, Square, Raised Panel, 8" @ 9'	\$ 309.23	\$ 290.67
CPSRA-08120	CPSRA-08120-4K	Column - PVC, Square, Raised Panel, 8" @ 10'	\$ 325.52	\$ 305.99
CPSRA-08144	CPSRA-08144-4K	Column - PVC, Square, Raised Panel, 8" @ 12'	\$ 358.20	\$ 336.71

10" COLUMNS

CPSRA-10048	CPSRA-10048-4K	Column - PVC, Square, Raised Panel, 10" @ 4'	\$ 247.88	\$ 233.01
CPSRA-10060	CPSRA-10060-4K	Column - PVC, Square, Raised Panel, 10" @ 5'	\$ 268.25	\$ 252.15
CPSRA-10072	CPSRA-10072-4K	Column - PVC, Square, Raised Panel, 10" @ 6'	\$ 288.62	\$ 271.31
CPSRA-10096	CPSRA-10096-4K	Column - PVC, Square, Raised Panel, 10" @ 8'	\$ 329.36	\$ 309.60
CPSRA-10108	CPSRA-10108-4K	Column - PVC, Square, Raised Panel, 10" @ 9'	\$ 349.73	\$ 328.74
CPSRA-10120	CPSRA-10120-4K	Column - PVC, Square, Raised Panel, 10" @ 10'	\$ 370.09	\$ 347.89
CPSRA-10144	CPSRA-10144-4K	Column - PVC, Square, Raised Panel, 10" @ 12'	\$ 410.94	\$ 386.28

12" COLUMNS

CPSRA-12048	CPSRA-12048-4K	Column - PVC, Square, Raised Panel, 12" @ 4'	\$ 268.00	\$ 251.92
CPSRA-12120	CPSRA-12060-4K	Column - PVC, Square, Raised Panel, 12" @ 5'	\$ 292.45	\$ 274.91
CPSRA-12072	CPSRA-12072-4K	Column - PVC, Square, Raised Panel, 12" @ 6'	\$ 316.89	\$ 297.88
CPSRA-12096	CPSRA-12096-4K	Column - PVC, Square, Raised Panel, 12" @ 8'	\$ 365.78	\$ 343.83
CPSRA-12108	CPSRA-12108-4K	Column - PVC, Square, Raised Panel, 12" @ 9'	\$ 390.22	\$ 366.81
CPSRA-12120	CPSRA-12120-4K	Column - PVC, Square, Raised Panel, 12" @ 10'	\$ 414.67	\$ 389.79
CPSRA-12144	CPSRA-12144-4K	Column - PVC, Square, Raised Panel, 12" @ 12'	\$ 463.68	\$ 435.86

14" COLUMNS

CPSRA-14048	CPSRA-14048-4K	Column - PVC, Square, Raised Panel, 14" @ 4'	\$ 298.63	\$ 280.71
CPSRA-14060	CPSRA-14060-4K	Column - PVC, Square, Raised Panel, 14" @ 5'	\$ 327.15	\$ 307.52
CPSRA-14072	CPSRA-14072-4K	Column - PVC, Square, Raised Panel, 14" @ 6'	\$ 355.66	\$ 334.32
CPSRA-14096	CPSRA-14096-4K	Column - PVC, Square, Raised Panel, 14" @ 8'	\$ 412.70	\$ 387.94
CPSRA-14108	CPSRA-14108-4K	Column - PVC, Square, Raised Panel, 14" @ 9'	\$ 441.21	\$ 414.74
CPSRA-14120	CPSRA-14120-4K	Column - PVC, Square, Raised Panel, 14" @ 10'	\$ 469.73	\$ 441.55
CPSRA-14144	CPSRA-14144-4K	Column - PVC, Square, Raised Panel, 14" @ 12'	\$ 526.91	\$ 495.30

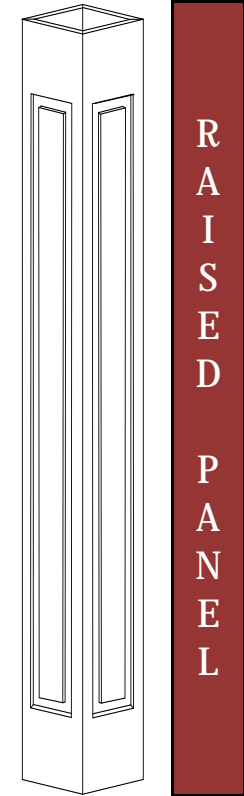

SIZE	DIMS	
	OUTSIDE	INSIDE
6"	5-1/2"	4-1/2"
8"	7-1/4"	6-1/4"
10"	9-3/8"	8-3/8"
12"	11-1/2"	10-1/2"
14"	13-1/4"	12-1/4"

***12% FOR CUSTOM HEIGHT & 12% FOR ACTUAL WIDTH & 12% FOR DOUBLE PANEL**
*****FOR COLUMNS LARGER THAN 14" PLEASE CONTACT YOUR LOCAL PRESTIGE DEALER**
****PRICES SUBJECT TO CHANGE WITHOUT NOTICE**

SQUARING "L" INCLUDED



***Add 3" to Outside Dims**



Standard C&B: 4" Craftsman	
CAP	4" Craftsman Skirt
BASE	4" Craftsman Skirt
<input checked="" type="checkbox"/> ADD CAP & BASE	

PRESTIGE COLUMNS - 2018

6" COLUMNS	PRODUCT CODE / SHAFT ONLY	PRODUCT CODE /w 4" SKIRTS	DESCRIPTION	1 PIECE	6 PIECE
		CPSFL-06048	CPSFL-06048-4K	Column - PVC, Square, Fluted Panel, 6" @ 4'	\$ 206.47
	CPSFL-06060	CPSFL-06060-4K	Column - PVC, Square, Fluted Panel, 6" @ 5'	\$ 218.70	\$ 205.57
	CPSFL-06072	CPSFL-06072-4K	Column - PVC, Square, Fluted Panel, 6" @ 6'	\$ 230.92	\$ 217.07
	CPSFL-06096	CPSFL-06096-4K	Column - PVC, Square, Fluted Panel, 6" @ 8'	\$ 255.36	\$ 240.04
	CPSFL-06108	CPSFL-06108-4K	Column - PVC, Square, Fluted Panel, 6" @ 9'	\$ 267.58	\$ 251.53
	CPSFL-06120	CPSFL-06120-4K	Column - PVC, Square, Fluted Panel, 6" @ 10'	\$ 279.81	\$ 263.02
	CPSFL-06144	CPSFL-06144-4K	Column - PVC, Square, Fluted Panel, 6" @ 12'	\$ 304.31	\$ 286.05
8" COLUMNS	CPSFL-08048	CPSFL-08048-4K	Column - PVC, Square, Fluted Panel, 8" @ 4'	\$ 227.75	\$ 214.08
	CPSFL-08060	CPSFL-08060-4K	Column - PVC, Square, Fluted Panel, 8" @ 5'	\$ 244.04	\$ 229.40
	CPSFL-08072	CPSFL-08072-4K	Column - PVC, Square, Fluted Panel, 8" @ 6'	\$ 260.34	\$ 244.72
	CPSFL-08096	CPSFL-08096-4K	Column - PVC, Square, Fluted Panel, 8" @ 8'	\$ 292.93	\$ 275.35
	CPSFL-08108	CPSFL-08108-4K	Column - PVC, Square, Fluted Panel, 8" @ 9'	\$ 309.23	\$ 290.67
	CPSFL-08120	CPSFL-08120-4K	Column - PVC, Square, Fluted Panel, 8" @ 10'	\$ 325.52	\$ 305.99
	CPSFL-08144	CPSFL-08144-4K	Column - PVC, Square, Fluted Panel, 8" @ 12'	\$ 358.20	\$ 336.71
10" COLUMNS	CPSFL-10048	CPSFL-10048-4K	Column - PVC, Square, Fluted Panel, 10" @ 4'	\$ 247.88	\$ 233.01
	CPSFL-10060	CPSFL-10060-4K	Column - PVC, Square, Fluted Panel, 10" @ 5'	\$ 268.25	\$ 252.15
	CPSFL-10072	CPSFL-10072-4K	Column - PVC, Square, Fluted Panel, 10" @ 6'	\$ 288.62	\$ 271.31
	CPSFL-10096	CPSFL-10096-4K	Column - PVC, Square, Fluted Panel, 10" @ 8'	\$ 329.36	\$ 309.60
	CPSFL-10108	CPSFL-10108-4K	Column - PVC, Square, Fluted Panel, 10" @ 9'	\$ 349.73	\$ 328.74
	CPSFL-10120	CPSFL-10120-4K	Column - PVC, Square, Fluted Panel, 10" @ 10'	\$ 370.09	\$ 347.89
	CPSFL-10144	CPSFL-10144-4K	Column - PVC, Square, Fluted Panel, 10" @ 12'	\$ 410.94	\$ 386.28
12" COLUMNS	CPSFL-12048	CPSFL-12048-4K	Column - PVC, Square, Fluted Panel, 12" @ 4'	\$ 268.00	\$ 251.92
	CPSFL-12060	CPSFL-12060-4K	Column - PVC, Square, Fluted Panel, 12" @ 5'	\$ 292.45	\$ 274.91
	CPSFL-12072	CPSFL-12072-4K	Column - PVC, Square, Fluted Panel, 12" @ 6'	\$ 316.89	\$ 297.88
	CPSFL-12096	CPSFL-12096-4K	Column - PVC, Square, Fluted Panel, 12" @ 8'	\$ 365.78	\$ 343.83
	CPSFL-12108	CPSFL-12108-4K	Column - PVC, Square, Fluted Panel, 12" @ 9'	\$ 390.22	\$ 366.81
	CPSFL-12120	CPSFL-12120-4K	Column - PVC, Square, Fluted Panel, 12" @ 10'	\$ 414.67	\$ 389.79
	CPSFL-12144	CPSFL-12144-4K	Column - PVC, Square, Fluted Panel, 12" @ 12'	\$ 463.68	\$ 435.86
14" COLUMNS	CPSFL-14048	CPSFL-14048-4K	Column - PVC, Square, Fluted Panel, 14" @ 4'	\$ 298.63	\$ 280.71
	CPSFL-14060	CPSFL-14060-4K	Column - PVC, Square, Fluted Panel, 14" @ 5'	\$ 327.15	\$ 307.52
	CPSFL-14072	CPSFL-14072-4K	Column - PVC, Square, Fluted Panel, 14" @ 6'	\$ 355.66	\$ 334.32
	CPSFL-14096	CPSFL-14096-4K	Column - PVC, Square, Fluted Panel, 14" @ 8'	\$ 412.70	\$ 387.94
	CPSFL-14108	CPSFL-14108-4K	Column - PVC, Square, Fluted Panel, 14" @ 9'	\$ 441.21	\$ 414.74
	CPSFL-14120	CPSFL-14120-4K	Column - PVC, Square, Fluted Panel, 14" @ 10'	\$ 469.73	\$ 441.55
	CPSFL-14144	CPSFL-14144-4K	Column - PVC, Square, Fluted Panel, 14" @ 12'	\$ 526.91	\$ 495.30

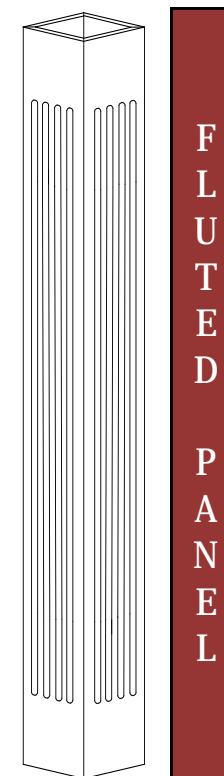

SIZE	DIMS	
	OUTSIDE	INSIDE
6"	5-1/2"	4-1/2"
8"	7-1/4"	6-1/4"
10"	9-3/8"	8-3/8"
12"	11-1/2"	10-1/2"
14"	13-1/4"	12-1/4"

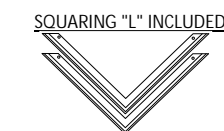

*Add 3" to Outside Dims

*12% FOR CUSTOM HEIGHT & 12% FOR ACTUAL WIDTH
 ***FOR COLUMNS LARGER THAN 14" PLEASE CONTACT YOUR LOCAL PRESTIGE DEALER
 **PRICES SUBJECT TO CHANGE WITHOUT NOTICE



Standard C&B: 4" Craftsman	
CAP	4" Craftsman Skirt
BASE	4" Craftsman Skirt
☑ ADD CAP & BASE	

PRESTIGE COLUMNS - 2018

8" COLUMNS

PRODUCT CODE / SHAFT ONLY
CPSRS-08048
CPSRS-08060
CPSRS-08072
CPSRS-08096
CPSRS-08108
CPSRS-08120
CPSRS-08144

PRODUCT CODE /w 4" SKIRTS
CPSRS-08048-4K
CPSRS-08060-4K
CPSRS-08072-4K
CPSRS-08096-4K
CPSRS-08108-4K
CPSRS-08120-4K
CPSRS-08144-4K

DESCRIPTION
Column - PVC, Square, Recessed Square Edge Panel, 8" @ 4'
Column - PVC, Square, Recessed Square Edge Panel, 8" @ 5'
Column - PVC, Square, Recessed Square Edge Panel, 8" @ 6'
Column - PVC, Square, Recessed Square Edge Panel, 8" @ 8'
Column - PVC, Square, Recessed Square Edge Panel, 8" @ 9'
Column - PVC, Square, Recessed Square Edge Panel, 8" @ 10'
Column - PVC, Square, Recessed Square Edge Panel, 8" @ 12'

	1 PIECE	6 PIECE
\$ 237.07	\$ 222.85	
\$ 261.57	\$ 245.88	
\$ 286.07	\$ 268.91	
\$ 335.07	\$ 314.97	
\$ 359.57	\$ 338.00	
\$ 384.07	\$ 361.02	
\$ 433.07	\$ 407.08	

10" COLUMNS

CPSRS-10048
CPSRS-10060
CPSRS-10072
CPSRS-10096
CPSRS-10108
CPSRS-10120
CPSRS-10144

CPSRS-10048-4K
CPSRS-10060-4K
CPSRS-10072-4K
CPSRS-10096-4K
CPSRS-10108-4K
CPSRS-10120-4K
CPSRS-10144-4K

Column - PVC, Square, Recessed Square Edge Panel, 10" @ 4'
Column - PVC, Square, Recessed Square Edge Panel, 10" @ 5'
Column - PVC, Square, Recessed Square Edge Panel, 10" @ 6'
Column - PVC, Square, Recessed Square Edge Panel, 10" @ 8'
Column - PVC, Square, Recessed Square Edge Panel, 10" @ 9'
Column - PVC, Square, Recessed Square Edge Panel, 10" @ 10'
Column - PVC, Square, Recessed Square Edge Panel, 10" @ 12'

\$ 265.35	\$ 249.43
\$ 297.40	\$ 279.56
\$ 329.47	\$ 309.70
\$ 393.59	\$ 369.97
\$ 425.65	\$ 400.11
\$ 457.70	\$ 430.24
\$ 521.83	\$ 490.52

12" COLUMNS

CPSRS-12048
CPSRS-12060
CPSRS-12072
CPSRS-12096
CPSRS-12108
CPSRS-12120
CPSRS-12144

CPSRS-12048-4K
CPSRS-12060-4K
CPSRS-12072-4K
CPSRS-12096-4K
CPSRS-12108-4K
CPSRS-12120-4K
CPSRS-12144-4K

Column - PVC, Square, Recessed Square Edge Panel, 12" @ 4'
Column - PVC, Square, Recessed Square Edge Panel, 12" @ 5'
Column - PVC, Square, Recessed Square Edge Panel, 12" @ 6'
Column - PVC, Square, Recessed Square Edge Panel, 12" @ 8'
Column - PVC, Square, Recessed Square Edge Panel, 12" @ 9'
Column - PVC, Square, Recessed Square Edge Panel, 12" @ 10'
Column - PVC, Square, Recessed Square Edge Panel, 12" @ 12'

\$ 290.73	\$ 273.29
\$ 329.12	\$ 309.37
\$ 367.51	\$ 345.46
\$ 444.29	\$ 417.63
\$ 500.02	\$ 470.02
\$ 521.07	\$ 489.81
\$ 597.85	\$ 561.98

14" COLUMNS

CPSRS-14048
CPSRS-14060
CPSRS-14072
CPSRS-14096
CPSRS-14108
CPSRS-14120
CPSRS-14144

CPSRS-14048-4K
CPSRS-14060-4K
CPSRS-14072-4K
CPSRS-14096-4K
CPSRS-14108-4K
CPSRS-14120-4K
CPSRS-14144-4K

Column - PVC, Square, Recessed Square Edge Panel, 14" @ 4'
Column - PVC, Square, Recessed Square Edge Panel, 14" @ 5'
Column - PVC, Square, Recessed Square Edge Panel, 14" @ 6'
Column - PVC, Square, Recessed Square Edge Panel, 14" @ 8'
Column - PVC, Square, Recessed Square Edge Panel, 14" @ 9'
Column - PVC, Square, Recessed Square Edge Panel, 14" @ 10'
Column - PVC, Square, Recessed Square Edge Panel, 14" @ 12'

\$ 325.01	\$ 305.51
\$ 370.75	\$ 348.50
\$ 416.50	\$ 391.51
\$ 507.99	\$ 477.51
\$ 553.74	\$ 520.51
\$ 599.48	\$ 563.51
\$ 690.97	\$ 649.52

***12% FOR CUSTOM HEIGHT & 12% FOR ACTUAL WIDTH**
*****FOR COLUMNS LARGER THAN 14" PLEASE CONTACT YOUR LOCAL PRESTIGE DEALER**
****PRICES SUBJECT TO CHANGE WITHOUT NOTICE**

NOTE:

6" - 10" columns with square edge recessed panels will use either a 3/8" or a 1/2" thick backer panel.
 12" columns and larger, with square edge recessed panels, will use a 1/2" thick backer panel.
 All columns with recessed panel with base cap trim will use a 3/8" thick backer panel.

Recessed panel with base cap trim will only wrap a 5" wide structure.

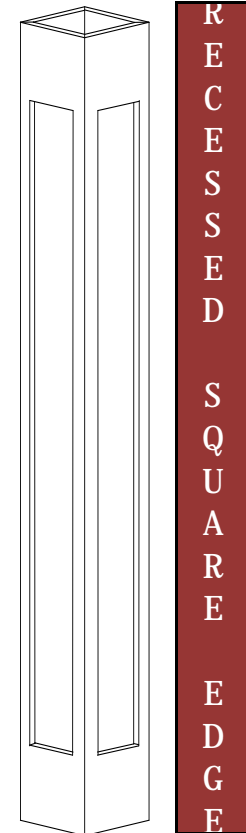

	DIMS	
SIZE	OUTSIDE	INSIDE
8"	7-1/4"	5-1/4"
10"	9-3/8"	7-3/8"
12"	11-1/2"	9-1/2"
14"	13-1/4"	11-1/4"

SQUARING "L" INCLUDED



***Add 3" to Outside Dims**



Standard C&B: 4" Craftsman	
CAP	4" Craftsman Skirt
BASE	4" Craftsman Skirt
<input checked="" type="checkbox"/> ADD CAP & BASE	

PRESTIGE COLUMNS - 2018

8" COLUMNS	PRODUCT CODE / SHAFT ONLY	PRODUCT CODE /w 4" SKIRTS	DESCRIPTION	1 PIECE	6 PIECE
		CPSRBF-08048	CPSRBF-08048-4K	Column - PVC, Square, Recessed Flush Trim Panel, 8" @ 4'	\$ 314.88
	CPSRBF-08060	CPSRBF-08060-4K	Column - PVC, Square, Recessed Flush Trim Panel, 8" @ 5'	\$ 349.87	\$ 328.88
	CPSRBF-08072	CPSRBF-08072-4K	Column - PVC, Square, Recessed Flush Trim Panel, 8" @ 6'	\$ 384.85	\$ 361.76
	CPSRBF-08096	CPSRBF-08096-4K	Column - PVC, Square, Recessed Flush Trim Panel, 8" @ 8'	\$ 454.81	\$ 427.52
	CPSRBF-08108	CPSRBF-08108-4K	Column - PVC, Square, Recessed Flush Trim Panel, 8" @ 9'	\$ 489.80	\$ 460.41
	CPSRBF-08120	CPSRBF-08120-4K	Column - PVC, Square, Recessed Flush Trim Panel, 8" @ 10'	\$ 524.78	\$ 493.29
	CPSRBF-08144	CPSRBF-08144-4K	Column - PVC, Square, Recessed Flush Trim Panel, 8" @ 12'	\$ 594.74	\$ 559.06
10" COLUMNS	CPSRBF-10048	CPSRBF-10048-4K	Column - PVC, Square, Recessed Flush Trim Panel, 10" @ 4'	\$ 342.88	\$ 322.30
	CPSRBF-10060	CPSRBF-10060-4K	Column - PVC, Square, Recessed Flush Trim Panel, 10" @ 5'	\$ 383.36	\$ 360.36
	CPSRBF-10072	CPSRBF-10072-4K	Column - PVC, Square, Recessed Flush Trim Panel, 10" @ 6'	\$ 423.84	\$ 398.41
	CPSRBF-10096	CPSRBF-10096-4K	Column - PVC, Square, Recessed Flush Trim Panel, 10" @ 8'	\$ 504.80	\$ 474.52
	CPSRBF-10108	CPSRBF-10108-4K	Column - PVC, Square, Recessed Flush Trim Panel, 10" @ 9'	\$ 545.29	\$ 512.58
	CPSRBF-10120	CPSRBF-10120-4K	Column - PVC, Square, Recessed Flush Trim Panel, 10" @ 10'	\$ 585.78	\$ 550.63
	CPSRBF-10144	CPSRBF-10144-4K	Column - PVC, Square, Recessed Flush Trim Panel, 10" @ 12'	\$ 666.74	\$ 626.74
12" COLUMNS	CPSRBF-12048	CPSRBF-12048-4K	Column - PVC, Square, Recessed Flush Trim Panel, 12" @ 4'	\$ 370.09	\$ 347.89
	CPSRBF-12060	CPSRBF-12060-4K	Column - PVC, Square, Recessed Flush Trim Panel, 12" @ 5'	\$ 416.08	\$ 391.12
	CPSRBF-12072	CPSRBF-12072-4K	Column - PVC, Square, Recessed Flush Trim Panel, 12" @ 6'	\$ 462.06	\$ 434.33
	CPSRBF-12096	CPSRBF-12096-4K	Column - PVC, Square, Recessed Flush Trim Panel, 12" @ 8'	\$ 554.02	\$ 520.78
	CPSRBF-12108	CPSRBF-12108-4K	Column - PVC, Square, Recessed Flush Trim Panel, 12" @ 9'	\$ 600.00	\$ 564.00
	CPSRBF-12120	CPSRBF-12120-4K	Column - PVC, Square, Recessed Flush Trim Panel, 12" @ 10'	\$ 645.98	\$ 607.22
	CPSRBF-12144	CPSRBF-12144-4K	Column - PVC, Square, Recessed Flush Trim Panel, 12" @ 12'	\$ 737.94	\$ 693.67
14" COLUMNS	CPSRBF-14048	CPSRBF-14048-4K	Column - PVC, Square, Recessed Flush Trim Panel, 14" @ 4'	\$ 408.46	\$ 383.95
	CPSRBF-14060	CPSRBF-14060-4K	Column - PVC, Square, Recessed Flush Trim Panel, 14" @ 5'	\$ 459.94	\$ 432.34
	CPSRBF-14072	CPSRBF-14072-4K	Column - PVC, Square, Recessed Flush Trim Panel, 14" @ 6'	\$ 511.42	\$ 480.74
	CPSRBF-14096	CPSRBF-14096-4K	Column - PVC, Square, Recessed Flush Trim Panel, 14" @ 8'	\$ 614.38	\$ 577.52
	CPSRBF-14108	CPSRBF-14108-4K	Column - PVC, Square, Recessed Flush Trim Panel, 14" @ 9'	\$ 665.86	\$ 625.91
	CPSRBF-14120	CPSRBF-14120-4K	Column - PVC, Square, Recessed Flush Trim Panel, 14" @ 10'	\$ 717.34	\$ 674.30
	CPSRBF-14144	CPSRBF-14144-4K	Column - PVC, Square, Recessed Flush Trim Panel, 14" @ 12'	\$ 820.30	\$ 771.08

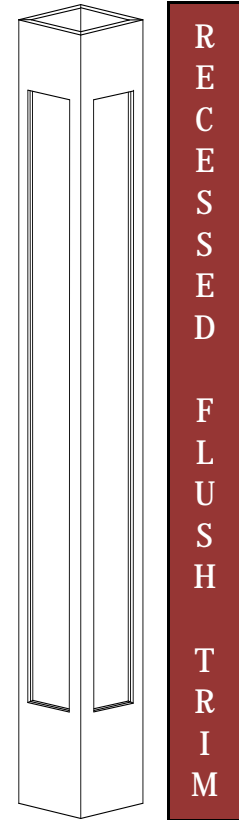

*12% FOR CUSTOM HEIGHT & 12% FOR ACTUAL WIDTH
 ***FOR COLUMNS LARGER THAN 14" PLEASE CONTACT YOUR LOCAL PRESTIGE DEALER
 **PRICES SUBJECT TO CHANGE WITHOUT NOTICE

NOTE:

6" - 10" columns with square edge recessed panels will use either a 3/8" or a 1/2" thick backer panel.
 12" columns and larger, with square edge recessed panels, will use a 1/2" thick backer panel.
 All columns with recessed panel with base cap trim will use a 3/8" thick backer panel.

Recessed panel with base cap trim will only wrap a 5" wide structure.

SIZE	DIMS	
	OUTSIDE	INSIDE
8"	7-1/4"	5-1/4"
10"	9-3/8"	7-3/8"
12"	11-1/2"	9-1/2"
14"	13-1/4"	11-1/4"

SQUARING "L" INCLUDED

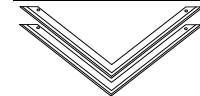

*Add 3" to Outside Dims



Standard C&B: 4" Craftsman	
CAP	4" Craftsman Skirt
BASE	4" Craftsman Skirt
<input checked="" type="checkbox"/> ADD CAP & BASE	

PRESTIGE COLUMNS - 2018

8" COLUMNS	PRODUCT CODE / SHAFT ONLY	PRODUCT CODE /w/ 4" SKIRTS	DESCRIPTION	1 PIECE	6 PIECE
		CPSRBR-08048	CPSRBR-08048-4K	Column - PVC, Square, Recessed Raised Trim Panel, 8" @ 4'	\$ 315.42
	CPSRBR-08060	CPSRBR-08060-4K	Column - PVC, Square, Recessed Raised Trim Panel, 8" @ 5'	\$ 350.48	\$ 329.45
	CPSRBR-08072	CPSRBR-08072-4K	Column - PVC, Square, Recessed Raised Trim Panel, 8" @ 6'	\$ 385.53	\$ 362.40
	CPSRBR-08096	CPSRBR-08096-4K	Column - PVC, Square, Recessed Raised Trim Panel, 8" @ 8'	\$ 455.63	\$ 428.29
	CPSRBR-08108	CPSRBR-08108-4K	Column - PVC, Square, Recessed Raised Trim Panel, 8" @ 9'	\$ 490.67	\$ 461.23
	CPSRBR-08120	CPSRBR-08120-4K	Column - PVC, Square, Recessed Raised Trim Panel, 8" @ 10'	\$ 525.72	\$ 494.18
	CPSRBR-08144	CPSRBR-08144-4K	Column - PVC, Square, Recessed Raised Trim Panel, 8" @ 12'	\$ 595.82	\$ 560.07
10" COLUMNS	CPSRBR-10048	CPSRBR-10048-4K	Column - PVC, Square, Recessed Raised Trim Panel, 10" @ 4'	\$ 343.47	\$ 322.87
	CPSRBR-10060	CPSRBR-10060-4K	Column - PVC, Square, Recessed Raised Trim Panel, 10" @ 5'	\$ 384.03	\$ 360.99
	CPSRBR-10072	CPSRBR-10072-4K	Column - PVC, Square, Recessed Raised Trim Panel, 10" @ 6'	\$ 424.59	\$ 399.11
	CPSRBR-10096	CPSRBR-10096-4K	Column - PVC, Square, Recessed Raised Trim Panel, 10" @ 8'	\$ 505.70	\$ 475.36
	CPSRBR-10108	CPSRBR-10108-4K	Column - PVC, Square, Recessed Raised Trim Panel, 10" @ 9'	\$ 546.27	\$ 513.49
	CPSRBR-10120	CPSRBR-10120-4K	Column - PVC, Square, Recessed Raised Trim Panel, 10" @ 10'	\$ 586.83	\$ 551.62
	CPSRBR-10144	CPSRBR-10144-4K	Column - PVC, Square, Recessed Raised Trim Panel, 10" @ 12'	\$ 667.94	\$ 627.86
12" COLUMNS	CPSRBR-12048	CPSRBR-12048-4K	Column - PVC, Square, Recessed Raised Trim Panel, 12" @ 4'	\$ 370.73	\$ 348.49
	CPSRBR-12060	CPSRBR-12060-4K	Column - PVC, Square, Recessed Raised Trim Panel, 12" @ 5'	\$ 416.80	\$ 391.79
	CPSRBR-12072	CPSRBR-12072-4K	Column - PVC, Square, Recessed Raised Trim Panel, 12" @ 6'	\$ 462.87	\$ 435.10
	CPSRBR-12096	CPSRBR-12096-4K	Column - PVC, Square, Recessed Raised Trim Panel, 12" @ 8'	\$ 555.01	\$ 521.71
	CPSRBR-12108	CPSRBR-12108-4K	Column - PVC, Square, Recessed Raised Trim Panel, 12" @ 9'	\$ 601.07	\$ 565.01
	CPSRBR-12120	CPSRBR-12120-4K	Column - PVC, Square, Recessed Raised Trim Panel, 12" @ 10'	\$ 647.14	\$ 608.31
	CPSRBR-12144	CPSRBR-12144-4K	Column - PVC, Square, Recessed Raised Trim Panel, 12" @ 12'	\$ 739.28	\$ 694.92
14" COLUMNS	CPSRBR-14048	CPSRBR-14048-4K	Column - PVC, Square, Recessed Raised Trim Panel, 14" @ 4'	\$ 409.16	\$ 384.61
	CPSRBR-14060	CPSRBR-14060-4K	Column - PVC, Square, Recessed Raised Trim Panel, 14" @ 5'	\$ 460.74	\$ 433.09
	CPSRBR-14072	CPSRBR-14072-4K	Column - PVC, Square, Recessed Raised Trim Panel, 14" @ 6'	\$ 512.32	\$ 481.58
	CPSRBR-14096	CPSRBR-14096-4K	Column - PVC, Square, Recessed Raised Trim Panel, 14" @ 8'	\$ 615.48	\$ 578.55
	CPSRBR-14108	CPSRBR-14108-4K	Column - PVC, Square, Recessed Raised Trim Panel, 14" @ 9'	\$ 667.05	\$ 627.03
	CPSRBR-14120	CPSRBR-14120-4K	Column - PVC, Square, Recessed Raised Trim Panel, 14" @ 10'	\$ 718.62	\$ 675.51
	CPSRBR-14144	CPSRBR-14144-4K	Column - PVC, Square, Recessed Raised Trim Panel, 14" @ 12'	\$ 821.78	\$ 772.47

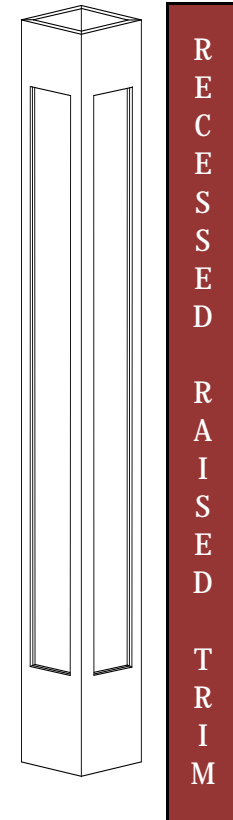

*12% FOR CUSTOM HEIGHT & 12% FOR ACTUAL WIDTH
 ***FOR COLUMNS LARGER THAN 14" PLEASE CONTACT YOUR LOCAL PRESTIGE DEALER
 **PRICES SUBJECT TO CHANGE WITHOUT NOTICE

NOTE:

6" - 10" columns with square edge recessed panels will use either a 3/8" or a 1/2" thick backer panel.
 12" columns and larger, with square edge recessed panels, will use a 1/2" thick backer panel.
 All columns with recessed panel with base cap trim will use a 3/8" thick backer panel.

Recessed panel with base cap trim will only wrap a 5" wide structure.

SIZE	DIMS	
	OUTSIDE	INSIDE
8"	7-1/4"	5-1/4"
10"	9-3/8"	7-3/8"
12"	11-1/2"	9-1/2"
14"	13-1/4"	11-1/4"

SQUARING "L" INCLUDED

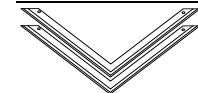

*Add 3" to Outside Dims

PRESTIGE COLUMNS - 2018

C
A
P
&
B
A
S
E
O
P
T
I
O
N
S

6" COLUMNS

PRODUCT CODE	DESCRIPTION	SINGLE SKIRT
CSP314	Skirt-PVC,CMN-6"Col-4"	\$ 10.22
CSP316	Skirt-PVC,CMN-6"Col-6"	\$ 11.61
CSP318	Skirt-PVC,CMN-6"Col-8"	\$ 12.82
CSP116	Skirt-PVC,BSE CP-6"Col-6"	\$ 24.84
CSP118	Skirt-PVC,BSE CP-6"Col-8"	\$ 27.33
CSP414	Skirt-PVC,CRWN-6"Col-4"	\$ 32.59
CSP415	Skirt-PVC,CRWN-6"Col-5"	\$ 43.93
CSP416	Skirt-PVC,CRWN-6"Col-6"	\$ 50.61
CSP616	Skirt-PVC,TSCN-6"Col-6"	\$ 49.63
CSP618	Skirt-PVC,TSCN-6"Col-8"	\$ 54.76
CSP61A	Skirt-PVC,TSCN-6"Col-10"	\$ 59.89
CSP716	Skirt-PVC,CHMFRD-6"Col-6"	\$ 40.19
CSP718	Skirt-PVC,CHMFRD-6"Col-8"	\$ 45.32
CSP71A	Skirt-PVC,CHMFRD-6"Col-10"	\$ 50.45
CSP512	Skirt-PVC,SLD CRWN-6"Col-2"	\$ 26.06
CSP914	Skirt-PVC,CONTEMP-6"Col-4"	\$ 26.80
CSP916	Skirt-PVC,CONTEMP-6"Col-6"	\$ 40.19
ASTRG-0606	Astragal-PVC, BSE CP-6" Col	\$ 31.55

8" COLUMNS

CSP324	Skirt-PVC,CMN-8"Col-4"	\$ 12.15
CSP326	Skirt-PVC,CMN-8"Col-6"	\$ 12.93
CSP328	Skirt-PVC,CMN-8"Col-8"	\$ 14.47
CSP126	Skirt-PVC,BSE CP-8"Col-6"	\$ 33.13
CSP128	Skirt-PVC,BSE CP-8"Col-8"	\$ 36.44
CSP424	Skirt-PVC,CRWN-8"Col-4"	\$ 37.42
CSP425	Skirt-PVC,CRWN-8"Col-5"	\$ 47.84
CSP426	Skirt-PVC,CRWN-8"Col-6"	\$ 54.78
CSP626	Skirt-PVC,TSCN-8"Col-6"	\$ 53.87
CSP628	Skirt-PVC,TSCN-8"Col-8"	\$ 60.43
CSP62A	Skirt-PVC,TSCN-8"Col-10"	\$ 66.98
CSP726	Skirt-PVC,CHMFRD-8"Col-6"	\$ 44.44
CSP728	Skirt-PVC,CHMFRD-8"Col-8"	\$ 50.99
CSP72A	Skirt-PVC,CHMFRD-8"Col-10"	\$ 57.54
CSP522	Skirt-PVC,SLD CRWN-8"Col-2"	\$ 28.94
CSP924	Skirt-PVC,CONTEMP-8" Col-4"	\$ 29.63
CSP926	Skirt-PVC,CONTEMP-8"Col-6"	\$ 44.44
ASTRG-0808	Astragal-PVC, BSE CP-8" Col	\$ 36.14

10" COLUMNS

CSP334	Skirt-PVC,CMN-10"col-4"	\$ 13.52
CSP336	Skirt-PVC,CMN-10"col-6"	\$ 20.34
CSP338	Skirt-PVC,CMN-10"col-8"	\$ 24.11
CSP136	Skirt-PVC,BSE CP-10"col-6"	\$ 41.40
CSP138	Skirt-PVC,BSE CP-10"col-8"	\$ 45.55
CSP434	Skirt-PVC,CRWN-10"col-4"	\$ 38.05
CSP435	Skirt-PVC,CRWN-10"col-5"	\$ 51.77
CSP436	Skirt-PVC,CRWN-10"col-6"	\$ 58.96
CSP636	Skirt-PVC,TSCN-10"col-6"	\$ 58.13
CSP638	Skirt-PVC,TSCN-10"col-8"	\$ 66.09
CSP63A	Skirt-PVC,TSCN-10"col-10"	\$ 74.07
CSP736	Skirt-PVC,CHMFRD-10"col-6"	\$ 48.69
CSP738	Skirt-PVC,CHMFRD-10"col-8"	\$ 56.65
CSP73A	Skirt-PVC,CHMFRD-10"col-10"	\$ 64.62
CSP532	Skirt-PVC,SLD CRWN-10"col-2"	\$ 31.82
CSP934	Skirt-PVC,CONTEMP-10" Col-4"	\$ 32.46
CSP936	Skirt-PVC,CONTEMP-10"Col-6"	\$ 48.69
ASTRG-1010	Astragal-PVC, BSE CP-10" Col	\$ 38.07

C
A
P
&
B
A
S
E

O
P
T
I
O
N
S

12" COLUMNS

CSP344	Skirt-PVC,CMN-12"col-4"	\$ 14.87
CSP346	Skirt-PVC,CMN-12"col-6"	\$ 22.45
CSP348	Skirt-PVC,CMN-12"col-8"	\$ 26.88
CSP146	Skirt-PVC,BSE CP-12"col-6"	\$ 49.69
CSP148	Skirt-PVC,BSE CP-12"col-8"	\$ 54.66
CSP444	Skirt-PVC,CRWN-12"col-4"	\$ 40.75
CSP445	Skirt-PVC,CRWN-12"col-5"	\$ 55.68
CSP446	Skirt-PVC,CRWN-12"col-6"	\$ 63.13
CSP645	Skirt-PVC,TSCN-12"col-5"	\$ 57.69
CSP646	Skirt-PVC,TSCN-12"col-6"	\$ 62.38
CSP648	Skirt-PVC,TSCN-12"col-8"	\$ 71.76
CSP64A	Skirt-PVC,TSCN-12"col-10"	\$ 81.15
CSP746	Skirt-PVC,CHMFRD-12"col-6"	\$ 52.93
CSP748	Skirt-PVC,CHMFRD-12"col-8"	\$ 62.33
CSP74A	Skirt-PVC,CHMFRD-12"col-10"	\$ 71.70
CSP542	Skirt-PVC,SLD CRWN-12"col-2"	\$ 34.71
CSP944	Skirt-PVC,CONTEMP-12" Col-4"	\$ 35.29
CSP946	Skirt-PVC,CONTEMP-12" Col-6"	\$ 52.93
ASTRG-1212	Astragal-PVC, BSE CP-12" Col	\$ 40.00

14" COLUMNS

CSP354	Skirt-PVC,CMN-14"col-4"	\$ 19.48
CSP356	Skirt-PVC,CMN-14"col-6"	\$ 29.46
CSP358	Skirt-PVC,CMN-14"col-8"	\$ 35.57
CSP156	Skirt-PVC,BSE CP-14"col-6"	\$ 69.56
CSP158	Skirt-PVC,BSE CP-14"col-8"	\$ 76.52
CSP454	Skirt-PVC,CRWN-14"col-4"	\$ 52.17
CSP455	Skirt-PVC,CRWN-14"col-5"	\$ 71.51
CSP456	Skirt-PVC,CRWN-14"col-6"	\$ 80.78
CSP656	Skirt-PVC,TSCN-14"col-6"	\$ 79.95
CSP658	Skirt-PVC,TSCN-14"col-8"	\$ 92.91
CSP65A	Skirt-PVC,TSCN-14"col-10"	\$ 105.88
CSP756	Skirt-PVC,CHMFRD-14"col-6"	\$ 68.62
CSP758	Skirt-PVC,CHMFRD-14"col-8"	\$ 81.59
CSP75A	Skirt-PVC,CHMFRD-14"col-10"	\$ 94.55
CSP552	Skirt-PVC,SLD CRWN-14"col-2"	\$ 45.11
CSP954	Skirt-PVC,CONTEMP-14" Col-4"	\$ 45.74
CSP956	Skirt-PVC,CONTEMP-14" Col-6"	\$ 68.62
ASTRG-1414	Astragal-PVC, BSE CP-14" Col	\$ 50.36

**PRICES SUBJECT TO CHANGE WITHOUT NOTICE



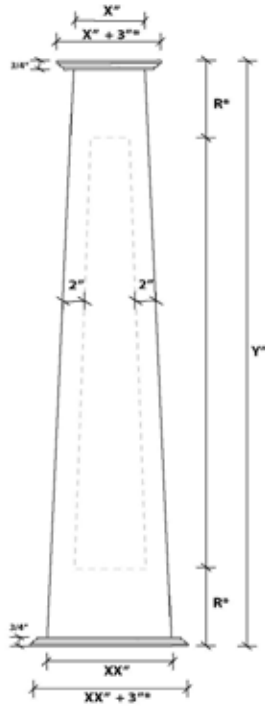

*Tuscan, Channeled & Solid Crown Add 4"

**Note: For more column dimension information, see Prestige Columns Reference Guide (On Reverse). Customers are responsible for confirming inside dimensions prior to ordering. Please consult your Prestige Products representative when ordering. All approved custom column orders are non-refundable.

CUSTOM TAPERED COLUMN LAYOUT

CLIENT INFORMATION		PANEL SIZES	
Dealer Name: _____		1. Height (Y") _____	
Project: _____		2. Top Width (X") _____	
PO#: _____		3. Bottom Width (XX") _____	
Project Contact: _____		Note: Tapered column panels are always actual dimensions.	
Date: _____		3. Inside Dims _____	
Approved By: _____		4. Painted: No <input type="checkbox"/> Yes <input type="checkbox"/>	
		COROUR: _____	

PANEL PROFILE		NOTES:	
1. Plain <input type="checkbox"/>		_____	
2. Fluted <input type="checkbox"/>		_____	
3. Raised <input type="checkbox"/>		_____	
4. Recessed <input type="checkbox"/>		_____	
- Square Edge		1. Single Panel <input type="checkbox"/>	
- Round Edge		2. Double Panel <input type="checkbox"/>	
- w/ Base Cap Trim		3. 1/3 - 2/3 Panel <input type="checkbox"/>	
- Flush Trim		4. Custom _____	
		Panel Locks: M <input type="checkbox"/> F <input type="checkbox"/>	

CAPS & BASES		Place a 'T' for Column Top Place 'B' for Column Bottom	
Craftsman		Chamfered	
4" <input type="checkbox"/>	6" <input type="checkbox"/>	4" <input type="checkbox"/>	6" <input type="checkbox"/>
8" <input type="checkbox"/>	10" <input type="checkbox"/>	8" <input type="checkbox"/>	10" <input type="checkbox"/>
Crown Mould		Base Cap Edge	
4" <input type="checkbox"/>	5" <input type="checkbox"/>	4" <input type="checkbox"/>	6" <input type="checkbox"/>
6" <input type="checkbox"/>	8" <input type="checkbox"/>	8" <input type="checkbox"/>	10" <input type="checkbox"/>
Tuscan		Solid Crown	
5" <input type="checkbox"/>	6" <input type="checkbox"/>	1 <input type="checkbox"/>	2 <input type="checkbox"/>
8" <input type="checkbox"/>	10" <input type="checkbox"/>		



Prestige Column Sizes & Reveals - Tapered Columns

Product Code	Prestige PVC Tapered Columns	Base Width (inches)	Top Width (inches)	Interior Base Width (inches)	Interior Top Width (inches)	Column Height (ft)	Column Weight (lbs)
CP10-1000-010	Prestige Columns - PVC Square Tapered - Plain Panel - 10" x 10" x 8"	10"	10"	8"	8"	10	45
CP10-1000-020	Prestige Columns - PVC Square Tapered - Plain Panel - 10" x 10" x 8"	10"	10"	8"	8"	10	45
CP10-1000-030	Prestige Columns - PVC Square Tapered - Plain Panel - 10" x 10" x 8"	10"	10"	8"	8"	10	45
CP10-1000-040	Prestige Columns - PVC Square Tapered - Plain Panel - 10" x 10" x 8"	10"	10"	8"	8"	10	45
CP10-1000-050	Prestige Columns - PVC Square Tapered - Plain Panel - 10" x 10" x 8"	10"	10"	8"	8"	10	45
CP10-1000-060	Prestige Columns - PVC Square Tapered - Plain Panel - 10" x 10" x 8"	10"	10"	8"	8"	10	45
CP10-1000-070	Prestige Columns - PVC Square Tapered - Plain Panel - 10" x 10" x 8"	10"	10"	8"	8"	10	45
CP10-1000-080	Prestige Columns - PVC Square Tapered - Plain Panel - 10" x 10" x 8"	10"	10"	8"	8"	10	45
CP10-1000-090	Prestige Columns - PVC Square Tapered - Plain Panel - 10" x 10" x 8"	10"	10"	8"	8"	10	45
CP10-1000-100	Prestige Columns - PVC Square Tapered - Plain Panel - 10" x 10" x 8"	10"	10"	8"	8"	10	45

NOTE: * Will Not Fit Around 6" x 6" Wood Structure.
Packaging: Standard Kit consists of boxed, 4 column panels, cap/base with adhesive (1/2 lb), spigots (1/2 lb), 2 lbs. self-tapping screws, fasteners, instructions.

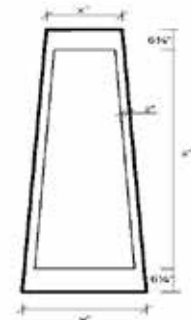

NOTE:
 • 6" - 10" columns with square edge recessed panels will use either a 1/2" or a 3/4" thick backer panel.
 • 12" columns and larger with square edge recessed panels will use a 1" thick backer panel.
 • All columns with recessed panel with base cap trim will use a 3/8" thick column shaft and backer panel.
 • All columns with a base of 10" or larger will use a 5/8" thick column shaft.





Standard C&B: 4" Craftsman	
CAP	4" Craftsman Skirt Set
BASE	4" Craftsman Skirt Set
<input checked="" type="checkbox"/> ADD CAP & BASE	

PRESTIGE TAPERED COLUMNS - 2018

9" - 6" TAPERED COLUMNS

PRODUCT CODE / SHAFT ONLY	PRODUCT CODE /w 4" SKIRTS	DESCRIPTION	1 PIECE	6 PIECE
CPTPL-0906048	CPTPL-0906048-4K	Column - PVC, Tapered, Plain Panel, 9"-6" @ 4'	\$ 189.73	\$ 178.35
CPTPL-0906060	CPTPL-0906060-4K	Column - PVC, Tapered, Plain Panel, 9"-6" @ 5'	\$ 204.43	\$ 192.17
CPTPL-0906072	CPTPL-0906072-4K	Column - PVC, Tapered, Plain Panel, 9"-6" @ 6'	\$ 219.14	\$ 205.99
CPTPL-0906096	CPTPL-0906096-4K	Column - PVC, Tapered, Plain Panel, 9"-6" @ 8'	\$ 248.55	\$ 233.64
CPTPL-0906120	CPTPL-0906120-4K	Column - PVC, Tapered, Plain Panel, 9"-6" @ 10'	\$ 277.96	\$ 261.28
CPTPL-0906144	CPTPL-0906144-4K	Column - PVC, Tapered, Plain Panel, 9"-6" @ 12'	\$ 307.44	\$ 289.00

12" - 8" TAPERED COLUMNS

CPTPL-1208048	CPTPL-1208048-4K	Column - PVC, Tapered, Plain Panel, 12"-8" @ 4'	\$ 214.33	\$ 201.47
CPTPL-1208060	CPTPL-1208060-4K	Column - PVC, Tapered, Plain Panel, 12"-8" @ 5'	\$ 233.93	\$ 219.89
CPTPL-1208072	CPTPL-1208072-4K	Column - PVC, Tapered, Plain Panel, 12"-8" @ 6'	\$ 253.53	\$ 238.32
CPTPL-1208096	CPTPL-1208096-4K	Column - PVC, Tapered, Plain Panel, 12"-8" @ 8'	\$ 292.74	\$ 275.18
CPTPL-1208120	CPTPL-1208120-4K	Column - PVC, Tapered, Plain Panel, 12"-8" @ 10'	\$ 331.96	\$ 312.04
CPTPL-1208144	CPTPL-1208144-4K	Column - PVC, Tapered, Plain Panel, 12"-8" @ 12'	\$ 371.27	\$ 349.00

13" - 9" TAPERED COLUMNS

CPTPL-1309048	CPTPL-1309048-4K	Column - PVC, Tapered, Plain Panel, 13"-9" @ 4'	\$ 224.13	\$ 210.69
CPTPL-1309060	CPTPL-1309060-4K	Column - PVC, Tapered, Plain Panel, 13"-9" @ 5'	\$ 245.69	\$ 230.95
CPTPL-1309072	CPTPL-1309072-4K	Column - PVC, Tapered, Plain Panel, 13"-9" @ 6'	\$ 267.27	\$ 251.23
CPTPL-1309096	CPTPL-1309096-4K	Column - PVC, Tapered, Plain Panel, 13"-9" @ 8'	\$ 310.41	\$ 291.78
CPTPL-1309120	CPTPL-1309120-4K	Column - PVC, Tapered, Plain Panel, 13"-9" @ 10'	\$ 353.54	\$ 332.32
CPTPL-1309144	CPTPL-1309144-4K	Column - PVC, Tapered, Plain Panel, 13"-9" @ 12'	\$ 396.78	\$ 372.97

16" - 12" TAPERED COLUMNS

CPTPL-1612048	CPTPL-1612048-4K	Column - PVC, Tapered, Plain Panel, 16"-12" @ 4'	\$ 253.51	\$ 238.30
CPTPL-1612060	CPTPL-1612060-4K	Column - PVC, Tapered, Plain Panel, 16"-12" @ 5'	\$ 280.97	\$ 264.11
CPTPL-1612072	CPTPL-1612072-4K	Column - PVC, Tapered, Plain Panel, 16"-12" @ 6'	\$ 308.41	\$ 289.90
CPTPL-1612096	CPTPL-1612096-4K	Column - PVC, Tapered, Plain Panel, 16"-12" @ 8'	\$ 363.31	\$ 341.52
CPTPL-1612120	CPTPL-1612120-4K	Column - PVC, Tapered, Plain Panel, 16"-12" @ 10'	\$ 418.21	\$ 393.12
CPTPL-1612144	CPTPL-1612144-4K	Column - PVC, Tapered, Plain Panel, 16"-12" @ 12'	\$ 473.25	\$ 444.85

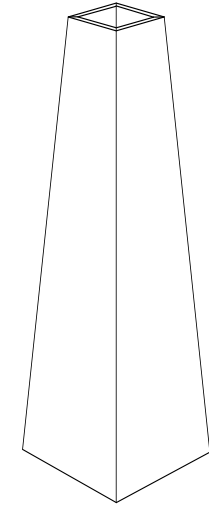

TAPERED PLAIN

*12% FOR CUSTOM HEIGHT
**PRICES SUBJECT TO CHANGE WITHOUT NOTICE

DIMS			
OUTSIDE		INSIDE	
TOP	BOTTOM	TOP	BOTTOM
6"	9"	5"	8"
8"	12"	7"	11"
9"	13"	8"	12"
12"	16"	11"	15"

SQUARING "L" INCLUDED



*Add 3" to Outside Dims



Standard C&B: 4" Craftsman	
CAP	4" Craftsman Skirt Set
BASE	4" Craftsman Skirt Set
<input checked="" type="checkbox"/> ADD CAP & BASE	

PRESTIGE TAPERED COLUMNS - 2018

9"- 6" TAPERED COLUMNS

PRODUCT CODE / SHAFT ONLY	PRODUCT CODE /w/ 4" SKIRTS	DESCRIPTION	1 PIECE	6 PIECE
CPTRA-0906048	CPTRA-0906048-4K	Column - PVC, Tapered, Raised Panel, 9"-6" @ 4'	\$ 223.24	\$ 209.84
CPTRA-0906060	CPTRA-0906060-4K	Column - PVC, Tapered, Raised Panel, 9"-6" @ 5'	\$ 237.95	\$ 223.68
CPTRA-0906072	CPTRA-0906072-4K	Column - PVC, Tapered, Raised Panel, 9"-6" @ 6'	\$ 252.65	\$ 237.49
CPTRA-0906096	CPTRA-0906096-4K	Column - PVC, Tapered, Raised Panel, 9"-6" @ 8'	\$ 282.99	\$ 266.01
CPTRA-0906120	CPTRA-0906120-4K	Column - PVC, Tapered, Raised Panel, 9"-6" @ 10'	\$ 311.47	\$ 292.78
CPTRA-0906144	CPTRA-0906144-4K	Column - PVC, Tapered, Raised Panel, 9"-6" @ 12'	\$ 340.96	\$ 320.50

12" - 8" TAPERED COLUMNS

CPTRA-1208048	CPTRA-1208048-4K	Column - PVC, Tapered, Raised Panel, 12"-8" @ 4'	\$ 247.83	\$ 232.96
CPTRA-1208060	CPTRA-1208060-4K	Column - PVC, Tapered, Raised Panel, 12"-8" @ 5'	\$ 267.43	\$ 251.39
CPTRA-1208072	CPTRA-1208072-4K	Column - PVC, Tapered, Raised Panel, 12"-8" @ 6'	\$ 287.04	\$ 269.82
CPTRA-1208096	CPTRA-1208096-4K	Column - PVC, Tapered, Raised Panel, 12"-8" @ 8'	\$ 326.26	\$ 306.69
CPTRA-1208120	CPTRA-1208120-4K	Column - PVC, Tapered, Raised Panel, 12"-8" @ 10'	\$ 365.47	\$ 343.54
CPTRA-1208144	CPTRA-1208144-4K	Column - PVC, Tapered, Raised Panel, 12"-8" @ 12'	\$ 404.78	\$ 380.50

13" - 9" TAPERED COLUMNS

CPTRA-1309048	CPTRA-1309048-4K	Column - PVC, Tapered, Raised Panel, 13"-9" @ 4'	\$ 257.64	\$ 242.18
CPTRA-1309060	CPTRA-1309060-4K	Column - PVC, Tapered, Raised Panel, 13"-9" @ 5'	\$ 279.22	\$ 262.47
CPTRA-1309072	CPTRA-1309072-4K	Column - PVC, Tapered, Raised Panel, 13"-9" @ 6'	\$ 300.78	\$ 282.74
CPTRA-1309096	CPTRA-1309096-4K	Column - PVC, Tapered, Raised Panel, 13"-9" @ 8'	\$ 343.91	\$ 323.28
CPTRA-1309120	CPTRA-1309120-4K	Column - PVC, Tapered, Raised Panel, 13"-9" @ 10'	\$ 387.05	\$ 363.83
CPTRA-1309144	CPTRA-1309144-4K	Column - PVC, Tapered, Raised Panel, 13"-9" @ 12'	\$ 430.30	\$ 404.48

16" - 12" TAPERED COLUMNS

CPTRA-1612048	CPTRA-1612048-4K	Column - PVC, Tapered, Raised Panel, 16"-12" @ 4'	\$ 287.03	\$ 269.81
CPTRA-1612060	CPTRA-1612060-4K	Column - PVC, Tapered, Raised Panel, 16"-12" @ 5'	\$ 314.47	\$ 295.61
CPTRA-1612072	CPTRA-1612072-4K	Column - PVC, Tapered, Raised Panel, 16"-12" @ 6'	\$ 341.93	\$ 321.41
CPTRA-1612096	CPTRA-1612096-4K	Column - PVC, Tapered, Raised Panel, 16"-12" @ 8'	\$ 396.83	\$ 373.02
CPTRA-1612120	CPTRA-1612120-4K	Column - PVC, Tapered, Raised Panel, 16"-12" @ 10'	\$ 451.72	\$ 424.62
CPTRA-1612144	CPTRA-1612144-4K	Column - PVC, Tapered, Raised Panel, 16"-12" @ 12'	\$ 506.77	\$ 476.36

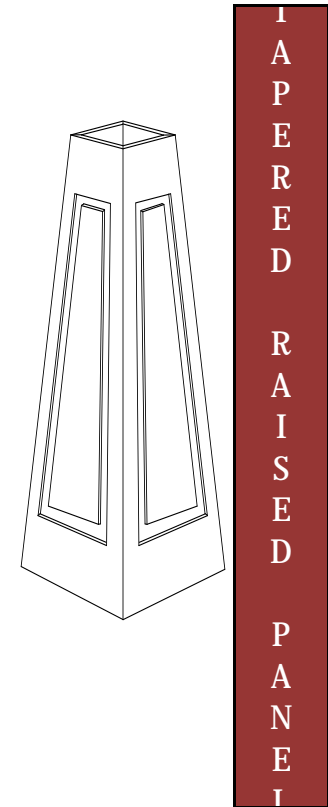

*12% FOR CUSTOM HEIGHT
**PRICES SUBJECT TO CHANGE WITHOUT NOTICE

DIMS			
OUTSIDE		INSIDE	
TOP	BOTTOM	TOP	BOTTOM
6"	9"	5"	8"
8"	12"	7"	11"
9"	13"	8"	12"
12"	16"	11"	15"

SQUARING "L" INCLUDED

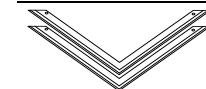

*Add 3" to Outside Dims



Standard C&B: 4" Craftsman	
CAP	4" Craftsman Skirt Set
BASE	4" Craftsman Skirt Set
<input checked="" type="checkbox"/> ADD CAP & BASE	

PRESTIGE TAPERED COLUMNS - 2018

12" - 8" TAPERED COLUMNS

PRODUCT CODE / SHAFT ONLY
CPTRS-1208048
CPTRS-1208060
CPTRS-1208072
CPTRS-1208096
CPTRS-1208120
CPTRS-1208144

PRODUCT CODE /w 4" SKIRTS
CPTRS-1208048-4K
CPTRS-1208060-4K
CPTRS-1208072-4K
CPTRS-1208096-4K
CPTRS-1208120-4K
CPTRS-1208144-4K

DESCRIPTION
Column - PVC, Tapered, Recessed Square Edge Panel, 12"-8" @ 4'
Column - PVC, Tapered, Recessed Square Edge Panel, 12"-8" @ 5'
Column - PVC, Tapered, Recessed Square Edge Panel, 12"-8" @ 6'
Column - PVC, Tapered, Recessed Square Edge Panel, 12"-8" @ 8'
Column - PVC, Tapered, Recessed Square Edge Panel, 12"-8" @ 10'
Column - PVC, Tapered, Recessed Square Edge Panel, 12"-8" @ 12'

1 PIECE	6 PIECE
\$ 266.25	\$ 250.27
\$ 298.77	\$ 280.84
\$ 331.29	\$ 311.41
\$ 396.35	\$ 372.57
\$ 461.40	\$ 433.72
\$ 526.56	\$ 494.96

13" - 9" TAPERED COLUMNS

CPTRS-1309048
CPTRS-1309060
CPTRS-1309072
CPTRS-1309096
CPTRS-1309120
CPTRS-1309144

CPTRS-1309048-4K
CPTRS-1309060-4K
CPTRS-1309072-4K
CPTRS-1309096-4K
CPTRS-1309120-4K
CPTRS-1309144-4K

Column - PVC, Tapered, Recessed Square Edge Panel, 13"-9" @ 4'
Column - PVC, Tapered, Recessed Square Edge Panel, 13"-9" @ 5'
Column - PVC, Tapered, Recessed Square Edge Panel, 13"-9" @ 6'
Column - PVC, Tapered, Recessed Square Edge Panel, 13"-9" @ 8'
Column - PVC, Tapered, Recessed Square Edge Panel, 13"-9" @ 10'
Column - PVC, Tapered, Recessed Square Edge Panel, 13"-9" @ 12'

\$ 279.25	\$ 262.49
\$ 315.26	\$ 296.35
\$ 351.27	\$ 330.20
\$ 423.30	\$ 397.90
\$ 495.33	\$ 465.61
\$ 567.47	\$ 533.42

16" - 12" TAPERED COLUMNS

CPTRS-1612048
CPTRS-1612060
CPTRS-1612072
CPTRS-1612096
CPTRS-1612120
CPTRS-1612144

CPTRS-1612048-4K
CPTRS-1612060-4K
CPTRS-1612072-4K
CPTRS-1612096-4K
CPTRS-1612120-4K
CPTRS-1612144-4K

Column - PVC, Tapered, Recessed Square Edge Panel, 16"-12" @ 4'
Column - PVC, Tapered, Recessed Square Edge Panel, 16"-12" @ 5'
Column - PVC, Tapered, Recessed Square Edge Panel, 16"-12" @ 6'
Column - PVC, Tapered, Recessed Square Edge Panel, 16"-12" @ 8'
Column - PVC, Tapered, Recessed Square Edge Panel, 16"-12" @ 10'
Column - PVC, Tapered, Recessed Square Edge Panel, 16"-12" @ 12'

\$ 318.40	\$ 299.29
\$ 364.87	\$ 342.98
\$ 411.34	\$ 386.66
\$ 504.29	\$ 474.03
\$ 597.22	\$ 561.39
\$ 690.31	\$ 648.89

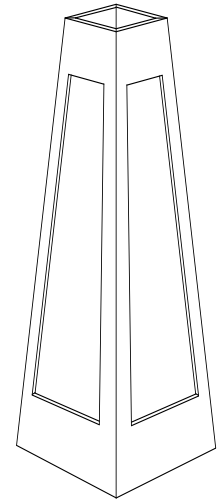

T
A
P
E
R
E
D

R
E
C
E
S
S
E
D

S
Q
U
A
R
E

E
D
G
E

*12% FOR CUSTOM HEIGHT
**PRICES SUBJECT TO CHANGE WITHOUT NOTICE

DIMS

OUTSIDE		INSIDE	
TOP	BOTTOM	TOP	BOTTOM
6"	9"	5"	8"
8"	12"	7"	11"
9"	13"	8"	12"
12"	16"	11"	15"

SQUARING "L" INCLUDED

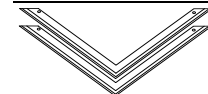

*Add 3" to Outside Dims



Standard C&B: 4" Craftsman	
CAP	4" Craftsman Skirt Set
BASE	4" Craftsman Skirt Set
<input checked="" type="checkbox"/> ADD CAP & BASE	

PRESTIGE TAPERED COLUMNS - 2018

12" - 8" TAPERED COLUMNS

PRODUCT CODE / SHAFT ONLY
CPTRBF-1208048
CPTRBF-1208060
CPTRBF-1208072
CPTRBF-1208096
CPTRBF-1208120
CPTRBF-1208144

PRODUCT CODE
CPTRBF-1208048-4K
CPTRBF-1208060-4K
CPTRBF-1208072-4K
CPTRBF-1208096-4K
CPTRBF-1208120-4K
CPTRBF-1208144-4K

DESCRIPTION
Column - PVC, Tapered, Recessed Flush Trim Panel, 12"-8" @ 4'
Column - PVC, Tapered, Recessed Flush Trim Panel, 12"-8" @ 5'
Column - PVC, Tapered, Recessed Flush Trim Panel, 12"-8" @ 6'
Column - PVC, Tapered, Recessed Flush Trim Panel, 12"-8" @ 8'
Column - PVC, Tapered, Recessed Flush Trim Panel, 12"-8" @ 10'
Column - PVC, Tapered, Recessed Flush Trim Panel, 12"-8" @ 12'

	1 PIECE	6 PIECE
\$ 317.58	\$ 298.53	
\$ 349.65	\$ 328.67	
\$ 381.72	\$ 358.82	
\$ 445.87	\$ 419.12	
\$ 510.02	\$ 479.42	
\$ 574.26	\$ 539.81	

13" - 9" TAPERED COLUMNS

CPTRBF-1309048
CPTRBF-1309060
CPTRBF-1309072
CPTRBF-1309096
CPTRBF-1309120
CPTRBF-1309144

CPTRBF-1309048-4K
CPTRBF-1309060-4K
CPTRBF-1309072-4K
CPTRBF-1309096-4K
CPTRBF-1309120-4K
CPTRBF-1309144-4K

Column - PVC, Tapered, Recessed Flush Trim Panel, 13"-9" @ 4'
Column - PVC, Tapered, Recessed Flush Trim Panel, 13"-9" @ 5'
Column - PVC, Tapered, Recessed Flush Trim Panel, 13"-9" @ 6'
Column - PVC, Tapered, Recessed Flush Trim Panel, 13"-9" @ 8'
Column - PVC, Tapered, Recessed Flush Trim Panel, 13"-9" @ 10'
Column - PVC, Tapered, Recessed Flush Trim Panel, 13"-9" @ 12'

\$ 329.46	\$ 309.69
\$ 363.50	\$ 341.69
\$ 397.53	\$ 373.68
\$ 465.59	\$ 437.65
\$ 533.66	\$ 501.64
\$ 601.84	\$ 565.73

16" - 12" TAPERED COLUMNS

CPTRBF-1612048
CPTRBF-1612060
CPTRBF-1612072
CPTRBF-1612096
CPTRBF-1612120
CPTRBF-1612144

CPTRBF-1612048-4K
CPTRBF-1612060-4K
CPTRBF-1612072-4K
CPTRBF-1612096-4K
CPTRBF-1612120-4K
CPTRBF-1612144-4K

Column - PVC, Tapered, Recessed Flush Trim Panel, 16"-12" @ 4'
Column - PVC, Tapered, Recessed Flush Trim Panel, 16"-12" @ 5'
Column - PVC, Tapered, Recessed Flush Trim Panel, 16"-12" @ 6'
Column - PVC, Tapered, Recessed Flush Trim Panel, 16"-12" @ 8'
Column - PVC, Tapered, Recessed Flush Trim Panel, 16"-12" @ 10'
Column - PVC, Tapered, Recessed Flush Trim Panel, 16"-12" @ 12'

\$ 360.19	\$ 338.58
\$ 400.10	\$ 376.09
\$ 440.01	\$ 413.61
\$ 519.84	\$ 488.65
\$ 599.66	\$ 563.68
\$ 679.65	\$ 638.87

*12% FOR CUSTOM HEIGHT
 **PRICES SUBJECT TO CHANGE WITHOUT NOTICE

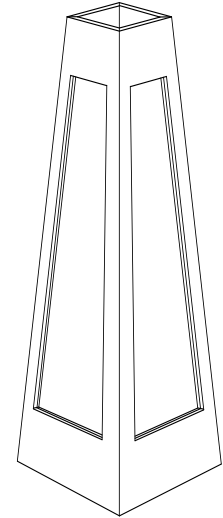

T
A
P
E
R
E
D

R
E
C
E
S
S
E
D

F
L
U
S
H

T
R
I
M

DIMS

OUTSIDE		INSIDE	
TOP	BOTTOM	TOP	BOTTOM
8"	12"	7"	11"
9"	13"	8"	12"
12"	16"	11"	15"

SQUARING "L" INCLUDED



*Add 3" to Outside Dims



PRESTIGE TAPERED COLUMNS - 2018

T
A
P
E
R
E
D

C
A
P

&

B
A
S
E

O
P
T
I
O
N
S

	PRODUCT CODE	DESCRIPTION	STANDARD PACKAGE	
<u>9" - 6" TAPERED COLUMNS</u>	CSP3C14T	Skirt-PVC,CMN-9"-6"Col-4" SET	\$	16.82
	CSP3C16T	Skirt-PVC,CMN-9"-6"Col-6" SET	\$	25.97
	CSP3C18T	Skirt-PVC,CMN-9"-6"Col-8" SET	\$	30.26
	CSP5C1T	Skirt-PVC,SLD CRWN-9"-6"Col SET	\$	37.63
<u>12" - 8" TAPERED COLUMNS</u>	CSP3424T	Skirt-PVC,CMN-12"-8"Col-4" SET	\$	19.36
	CSP3426T	Skirt-PVC,CMN-12"-8"Col-6" SET	\$	29.83
	CSP3428T	Skirt-PVC,CMN-12"-8"Col-8" SET	\$	35.36
	CSP542T	Skirt-PVC,SLD CRWN-12"-8"Col SET	\$	42.43
<u>13" - 9" TAPERED COLUMNS</u>	CSP3DC4T	Skirt-PVC,CMN-13"-9"Col-4" SET	\$	20.33
	CSP3DC6T	Skirt-PVC,CMN-13"-9"Col-6" SET	\$	31.37
	CSP3DC28T	Skirt-PVC,CMN-13"-9"Col-8" SET	\$	37.38
	CSP5DCT	Skirt-PVC,SLD CRWN-13"-9"Col SET	\$	44.34
<u>16" - 12" TAPERED COLUMNS</u>	CSP3644T	Skirt-PVC,CMN-16"-12"Col-4" SET	\$	23.39
	CSP3646T	Skirt-PVC,CMN-16"-12"Col-6" SET	\$	32.26
	CSP3648T	Skirt-PVC,CMN-16"-12"Col-8" SET	\$	40.04
	CSP564T	Skirt-PVC,SLD CRWN-16"-12"Col SET	\$	46.84

****PRICES SUBJECT TO CHANGE WITHOUT NOTICE**



PRESTIGE COLUMNS - 2018

(UF)Standard C&B: Chamfered 8" CP & 10 BSE	
CAP	8" Chamfered (4/4")
BASE	10" Chamfered (4/4")
<input checked="" type="checkbox"/> ADD CAP & BASE	

8" COLUMNS	PRODUCT CODE / SHAFT ONLY	PRODUCT CODE /W STND SKIRTS	DESCRIPTION	1 PIECE	6 PIECE
		CPSCH-08048	CPSCH-08048-UF	Column - PVC, Square, Chamfered Plain Panel, 8" @ 4'	\$ 254.25
	CPSCH-08060	CPSCH-08060-UF	Column - PVC, Square, Chamfered Plain Panel, 8" @ 5'	\$ 286.45	\$ 269.26
	CPSCH-08072	CPSCH-08072-UF	Column - PVC, Square, Chamfered Plain Panel, 8" @ 6'	\$ 318.64	\$ 299.52
	CPSCH-08096	CPSCH-08096-UF	Column - PVC, Square, Chamfered Plain Panel, 8" @ 8'	\$ 383.03	\$ 360.05
	CPSCH-08108	CPSCH-08108-UF	Column - PVC, Square, Chamfered Plain Panel, 8" @ 9'	\$ 415.23	\$ 390.31
	CPSCH-08120	CPSCH-08120-UF	Column - PVC, Square, Chamfered Plain Panel, 8" @ 10'	\$ 447.42	\$ 420.57
	CPSCH-08144	CPSCH-08144-UF	Column - PVC, Square, Chamfered Plain Panel, 8" @ 12'	\$ 511.81	\$ 481.10
10" COLUMNS					
	CPSCH-10048	CPSCH-10048-UF	Column - PVC, Square, Chamfered Plain Panel, 10" @ 4'	\$ 300.33	\$ 282.31
	CPSCH-10060	CPSCH-10060-UF	Column - PVC, Square, Chamfered Plain Panel, 10" @ 5'	\$ 340.58	\$ 320.15
	CPSCH-10072	CPSCH-10072-UF	Column - PVC, Square, Chamfered Plain Panel, 10" @ 6'	\$ 380.83	\$ 357.98
	CPSCH-10096	CPSCH-10096-UF	Column - PVC, Square, Chamfered Plain Panel, 10" @ 8'	\$ 461.32	\$ 433.65
	CPSCH-10108	CPSCH-10108-UF	Column - PVC, Square, Chamfered Plain Panel, 10" @ 9'	\$ 501.58	\$ 471.49
	CPSCH-10120	CPSCH-10120-UF	Column - PVC, Square, Chamfered Plain Panel, 10" @ 10'	\$ 541.83	\$ 509.32
	CPSCH-10144	CPSCH-10144-UF	Column - PVC, Square, Chamfered Plain Panel, 10" @ 12'	\$ 622.32	\$ 584.99
12" COLUMNS					
	CPSCH-12048	CPSCH-12048-UF	Column - PVC, Square, Chamfered Plain Panel, 12" @ 4'	\$ 346.41	\$ 325.62
	CPSCH-12060	CPSCH-12060-UF	Column - PVC, Square, Chamfered Plain Panel, 12" @ 5'	\$ 394.71	\$ 371.03
	CPSCH-12072	CPSCH-12072-UF	Column - PVC, Square, Chamfered Plain Panel, 12" @ 6'	\$ 443.02	\$ 416.44
	CPSCH-12096	CPSCH-12096-UF	Column - PVC, Square, Chamfered Plain Panel, 12" @ 8'	\$ 539.63	\$ 507.25
	CPSCH-12108	CPSCH-12108-UF	Column - PVC, Square, Chamfered Plain Panel, 12" @ 9'	\$ 587.93	\$ 552.65
	CPSCH-12120	CPSCH-12120-UF	Column - PVC, Square, Chamfered Plain Panel, 12" @ 10'	\$ 636.23	\$ 598.06
	CPSCH-12144	CPSCH-12144-UF	Column - PVC, Square, Chamfered Plain Panel, 12" @ 12'	\$ 732.84	\$ 688.87
14" COLUMNS					
	CPSCH-14048	CPSCH-14048-UF	Column - PVC, Square, Chamfered Plain Panel, 14" @ 4'	\$ 429.00	\$ 403.26
	CPSCH-14060	CPSCH-14060-UF	Column - PVC, Square, Chamfered Plain Panel, 14" @ 5'	\$ 443.24	\$ 416.65
	CPSCH-14072	CPSCH-14072-UF	Column - PVC, Square, Chamfered Plain Panel, 14" @ 6'	\$ 499.60	\$ 469.62
	CPSCH-14096	CPSCH-14096-UF	Column - PVC, Square, Chamfered Plain Panel, 14" @ 8'	\$ 612.29	\$ 575.55
	CPSCH-14108	CPSCH-14108-UF	Column - PVC, Square, Chamfered Plain Panel, 14" @ 9'	\$ 668.65	\$ 628.53
	CPSCH-14120	CPSCH-14120-UF	Column - PVC, Square, Chamfered Plain Panel, 14" @ 10'	\$ 724.99	\$ 681.49
	CPSCH-14144	CPSCH-14144-UF	Column - PVC, Square, Chamfered Plain Panel, 14" @ 12'	\$ 837.70	\$ 787.43

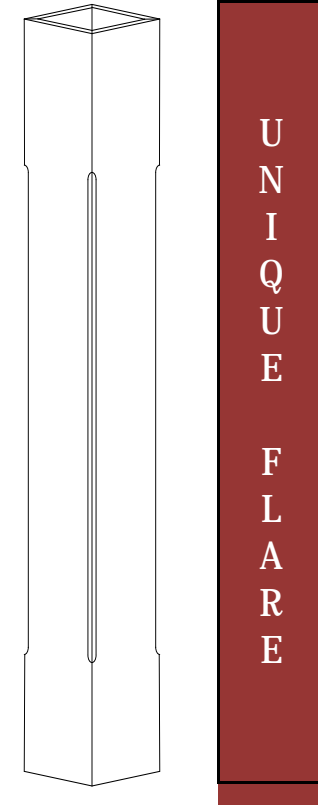

****FOR COLUMNS WITH SKIRTS HIGHER THAN 6" THE UPPER & LOWER REVEAL MOVES TO 14" from 9"**
***12% FOR CUSTOM HEIGHT & 12% FOR ACTUAL WIDTH**
*****FOR COLUMNS LARGER THAN 14" PLEASE CONTACT YOUR LOCAL PRESTIGE DEALER**
****PRICES SUBJECT TO CHANGE WITHOUT NOTICE**

SIZE	DIMS	
	OUTSIDE	INSIDE
6"	5-1/2"	3-1/2"
8"	7-1/4"	5-1/4"
10"	9-3/8"	7-3/8"
12"	11-1/2"	9-1/2"
14"	13-1/4"	11-1/4"



***Add 4" to Outside Dims**



PRESTIGE NEWEL POSTS - 2018



PRESTIGE NEWEL

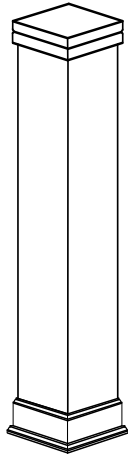

WIDTH	HEIGHT	PRODUCT CODE	PRICE
6"	24	NP(00)-0624-(YY)	\$ 59.49
	32	NP(00)-0632-(YY)	\$ 77.62
	36	NP(00)-0636-(YY)	\$ 86.67
	42	NP(00)-0642-(YY)	\$ 100.27
	46	NP(00)-0646-(YY)	\$ 109.33
8"	24	NP(00)-0824-(YY)	\$ 78.58
	32	NP(00)-0832-(YY)	\$ 96.67
	36	NP(00)-0836-(YY)	\$ 108.75
	42	NP(00)-0842-(YY)	\$ 126.88
	46	NP(00)-0846-(YY)	\$ 138.96
10"	24	NP(00)-1024-(YY)	\$ 90.63
	32	NP(00)-1032-(YY)	\$ 120.84
	36	NP(00)-1036-(YY)	\$ 135.94
	42	NP(00)-1042-(YY)	\$ 158.60
	46	NP(00)-1046-(YY)	\$ 173.70
12"	24	NP(00)-1224-(YY)	\$ 108.75
	32	NP(00)-1232-(YY)	\$ 145.01
	36	NP(00)-1236-(YY)	\$ 163.13
	42	NP(00)-1242-(YY)	\$ 190.32
	46	NP(00)-1246-(YY)	\$ 208.45
14"	24	NP(00)-1424-(YY)	\$ 126.88
	32	NP(00)-1432-(YY)	\$ 169.17
	36	NP(00)-1436-(YY)	\$ 190.32
	42	NP(00)-1442-(YY)	\$ 222.04
	46	NP(00)-1446-(YY)	\$ 243.19

*ALL NEWELS COME WITH 4" CRAFTSMAN BASE AND CHOICE OF LID (FLAT OR CHAMFERED)

NEWEL OPTIONS	PRODUCT CODE	SELECT	SELECTED OPTIONS
PLAIN (STANDARD)	NP(PL)		
FLUTED - 25% Upcharge	NP(FL)	<input type="checkbox"/>	
RAISED PANEL - 20% Upcharge	NP(RA)	<input type="checkbox"/>	
RECESSED PANEL - 35% Upcharge	NP(RS)	<input type="checkbox"/>	
RECESSED FLUSH TRIM - 45% Upcharge	NP(RBF)	<input type="checkbox"/>	
STANDARD FLAT LID (FC)	6" - 10" LID - 15% Upcharge	<input type="checkbox"/>	
	12" - 14" LID - 20% Upcharge	<input type="checkbox"/>	
CHAMFERED LID (CC)	6" - 10" LID - 25% Upcharge	<input type="checkbox"/>	
	12" - 14" LID - 35% Upcharge	<input type="checkbox"/>	
PRICING INSTRUCTIONS			\$ -
ENTER PRICE INTO BLUE CELL			

PRODUCT CODE EXAMPLE:

NPFL-0624-FC = Newel Post-PVC, Fluted - 6" x 24" /w 4" CFMN SKT & FLAT CAP



PRESTIGE NEWEL POST STYLES:

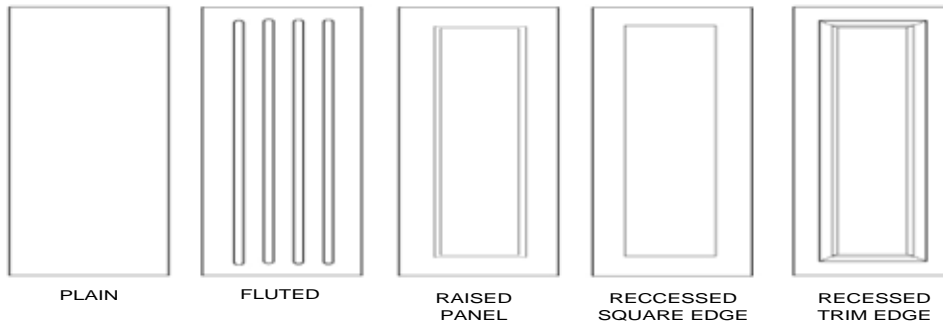

**PRICES SUBJECT TO CHANGE WITHOUT NOTICE



PRESTIGE NEWEL POSTS - 2018



P
R
E
S
T
I
G
E

P
L
I
N
T
H

B
O
X
E
S

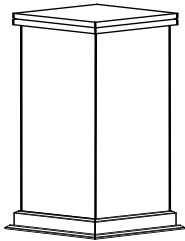

WIDTH	HEIGHT	PRODUCT CODE	PRICE
16"	24	PP(XX)-1624-(YY)	\$ 142.72
	32	PP(XX)-1632-(YY)	\$ 185.48
	36	PP(XX)-1636-(YY)	\$ 206.87
	42	PP(XX)-1642-(YY)	\$ 238.94
	46	PP(XX)-1646-(YY)	\$ 260.32
18"	24	PP(XX)-1824-(YY)	\$ 159.92
	32	PP(XX)-1832-(YY)	\$ 208.04
	36	PP(XX)-1836-(YY)	\$ 232.09
	42	PP(XX)-1842-(YY)	\$ 268.18
	46	PP(XX)-1846-(YY)	\$ 292.23
20"	24	PP(XX)-2024-(YY)	\$ 177.11
	32	PP(XX)-2032-(YY)	\$ 230.57
	36	PP(XX)-2036-(YY)	\$ 257.29
	42	PP(XX)-2042-(YY)	\$ 297.39
	46	PP(XX)-2046-(YY)	\$ 324.12
22"	24	PP(XX)-2224-(YY)	\$ 193.87
	32	PP(XX)-2232-(YY)	\$ 252.67
	36	PP(XX)-2236-(YY)	\$ 282.08
	42	PP(XX)-2242-(YY)	\$ 326.18
	46	PP(XX)-2246-(YY)	\$ 355.58
24"	24	PP(XX)-2424-(YY)	\$ 211.50
	32	PP(XX)-2432-(YY)	\$ 275.64
	36	PP(XX)-2436-(YY)	\$ 307.72
	42	PP(XX)-2442-(YY)	\$ 355.83
	46	PP(XX)-2446-(YY)	\$ 387.91

NEWEL OPTIONS	PRODUCT CODE	SELECT	SELECTED OPTIONS
PLAIN (STANDARD)	PP(PL)		
FLUTED - 25% Upcharge	PP(FL)	<input type="checkbox"/>	
RAISED PANEL - 20% Upcharge	PP(RA)	<input type="checkbox"/>	
RECESSED PANEL - 35% Upcharge	PP(RS)	<input type="checkbox"/>	
RECESSED FLUSH TRIM - 45% Upcharge	PP(RBF)	<input type="checkbox"/>	
STANDARD FLAT LID (FC)	16" - 20" LID - 15% Upcharge	<input type="checkbox"/>	
	22" - 24" LID - 20% Upcharge	<input type="checkbox"/>	
CHAMFERED LID (CC)	16" - 20" LID - 15% Upcharge	<input type="checkbox"/>	
	22" - 24" LID - 20% Upcharge	<input type="checkbox"/>	
PRICING INSTRUCTIONS			\$ -
ENTER PRICE INTO BLUE CELL			

PRODUCT CODE EXAMPLE:
PPFL-1824-FC - Plinth-PVC, Plain - 18" x 24" /w 4" CFMN SKT & FLAT CAP

*ALL PLINTHS COME WITH 4" CRAFTSMAN
BASE AND CHOICE OF LID (FLAT OR

PRESTIGE PLINTH BOX STYLES:

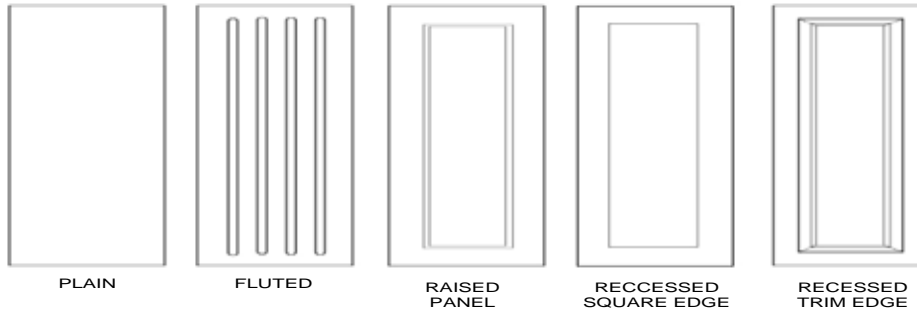

**PRICES SUBJECT TO CHANGE WITHOUT NOTICE



(CF)Standard C&B: 5" CRWN CP & 6" TSCN BSE	
CAP	5" Crown Mould
BASE	PVC Tuscan 6"
<input checked="" type="checkbox"/> ADD CAP & BASE	

PRESTIGE COLUMNS - 2018

	PRODUCT CODE / SHAFT ONLY	PRODUCT CODE / STND. SKIRTS	DESCRIPTION	1 PIECE	6 PIECE
8" COLUMNS	CPSPLS12-08048	CPSPLS12-08048-CF	Column - PVC, Square, Plain Panel /w Single 12" Lattice, 8" @ 4'	\$ 475.54	\$ 447.01
	CPSPLS12-08060	CPSPLS12-08060-CF	Column - PVC, Square, Plain Panel /w Single 12" Lattice, 8" @ 5'	\$ 540.58	\$ 508.14
	CPSPLS12-08072	CPSPLS12-08072-CF	Column - PVC, Square, Plain Panel /w Single 12" Lattice, 8" @ 6'	\$ 583.79	\$ 548.76
	CPSPLS12-08096	CPSPLS12-08096-CF	Column - PVC, Square, Plain Panel /w Single 12" Lattice, 8" @ 8'	\$ 692.04	\$ 650.52
	CPSPLS12-08108	CPSPLS12-08108-CF	Column - PVC, Square, Plain Panel /w Single 12" Lattice, 8" @ 9'	\$ 745.77	\$ 701.03
	CPSPLS12-08120	CPSPLS12-08120-CF	Column - PVC, Square, Plain Panel /w Single 12" Lattice, 8" @ 10'	\$ 800.29	\$ 752.27
	CPSPLS12-08144	CPSPLS12-08144-CF	Column - PVC, Square, Plain Panel /w Single 12" Lattice, 8" @ 12'	\$ 908.70	\$ 854.18
10" COLUMNS	CPSPLS12-10048	CPSPLS12-10048-CF	Column - PVC, Square, Plain Panel /w Single 12" Lattice, 10" @ 4'	\$ 517.13	\$ 486.10
	CPSPLS12-10060	CPSPLS12-10060-CF	Column - PVC, Square, Plain Panel /w Single 12" Lattice, 10" @ 5'	\$ 590.24	\$ 554.83
	CPSPLS12-10072	CPSPLS12-10072-CF	Column - PVC, Square, Plain Panel /w Single 12" Lattice, 10" @ 6'	\$ 641.52	\$ 603.03
	CPSPLS12-10096	CPSPLS12-10096-CF	Column - PVC, Square, Plain Panel /w Single 12" Lattice, 10" @ 8'	\$ 765.92	\$ 719.96
	CPSPLS12-10108	CPSPLS12-10108-CF	Column - PVC, Square, Plain Panel /w Single 12" Lattice, 10" @ 9'	\$ 828.11	\$ 778.42
	CPSPLS12-10120	CPSPLS12-10120-CF	Column - PVC, Square, Plain Panel /w Single 12" Lattice, 10" @ 10'	\$ 890.30	\$ 836.88
	CPSPLS12-10144	CPSPLS12-10144-CF	Column - PVC, Square, Plain Panel /w Single 12" Lattice, 10" @ 12'	\$ 1,014.91	\$ 954.01
12" COLUMNS	CPSPLS12-12048	CPSPLS12-12048-CF	Column - PVC, Square, Plain Panel /w Single 12" Lattice, 12" @ 4'	\$ 558.67	\$ 525.15
	CPSPLS12-12060	CPSPLS12-12060-CF	Column - PVC, Square, Plain Panel /w Single 12" Lattice, 12" @ 5'	\$ 639.86	\$ 601.47
	CPSPLS12-12072	CPSPLS12-12072-CF	Column - PVC, Square, Plain Panel /w Single 12" Lattice, 12" @ 6'	\$ 699.21	\$ 657.26
	CPSPLS12-12096	CPSPLS12-12096-CF	Column - PVC, Square, Plain Panel /w Single 12" Lattice, 12" @ 8'	\$ 839.74	\$ 789.36
	CPSPLS12-12108	CPSPLS12-12108-CF	Column - PVC, Square, Plain Panel /w Single 12" Lattice, 12" @ 9'	\$ 910.01	\$ 855.41
	CPSPLS12-12120	CPSPLS12-12120-CF	Column - PVC, Square, Plain Panel /w Single 12" Lattice, 12" @ 10'	\$ 980.28	\$ 921.47
	CPSPLS12-12144	CPSPLS12-12144-CF	Column - PVC, Square, Plain Panel /w Single 12" Lattice, 12" @ 12'	\$ 1,121.07	\$ 1,053.81

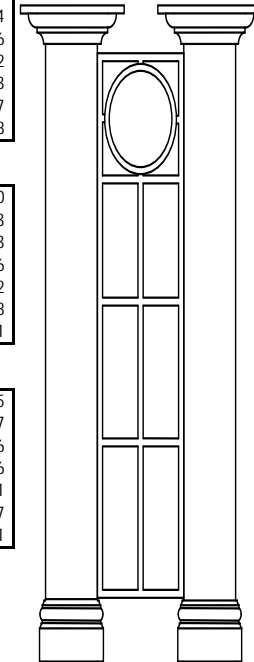

COCHREN FLARE

*12% FOR CUSTOM HEIGHT & 12% FOR ACTUAL WIDTH

***FOR COLUMNS LARGER THAN 14" PLEASE CONTACT YOUR LOCAL PRESTIGE DEALER

**PRICES SUBJECT TO CHANGE WITHOUT NOTICE

SQUARING "L" INCLUDED

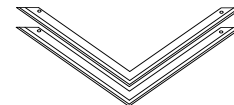

*Add 4" to Outside Dims

	DIMS	
SIZE	OUTSIDE	INSIDE
6"	5-1/2"	4-1/2"
8"	7-1/4"	6-1/4"
10"	9-3/8"	8-3/8"
12"	11-1/2"	10-1/2"
14"	13-1/4"	12-1/4"



(CF)Standard C&B: 5" CRWN CP & 6" TSCN BSE	
CAP	5" Crown Mould
BASE	PVC Tuscan 6"
<input checked="" type="checkbox"/> ADD CAP & BASE	

PRESTIGE COLUMNS - 2018

	PRODUCT CODE / SHAFT ONLY	PRODUCT CODE / STND SKIRTS	DESCRIPTION	1 PIECE	6 PIECE
8" COLUMNS	CPSPLS16-08048	CPSPLS16-08048-CF	Column - PVC, Square, Plain Panel /w Single 16" Lattice, 8" @ 4'	\$ 493.44	\$ 463.84
	CPSPLS16-08060	CPSPLS16-08060-CF	Column - PVC, Square, Plain Panel /w Single 16" Lattice, 8" @ 5'	\$ 569.23	\$ 535.07
	CPSPLS16-08072	CPSPLS16-08072-CF	Column - PVC, Square, Plain Panel /w Single 16" Lattice, 8" @ 6'	\$ 616.01	\$ 579.05
	CPSPLS16-08096	CPSPLS16-08096-CF	Column - PVC, Square, Plain Panel /w Single 16" Lattice, 8" @ 8'	\$ 738.58	\$ 694.27
	CPSPLS16-08108	CPSPLS16-08108-CF	Column - PVC, Square, Plain Panel /w Single 16" Lattice, 8" @ 9'	\$ 800.23	\$ 752.22
	CPSPLS16-08120	CPSPLS16-08120-CF	Column - PVC, Square, Plain Panel /w Single 16" Lattice, 8" @ 10'	\$ 861.16	\$ 809.49
	CPSPLS16-08144	CPSPLS16-08144-CF	Column - PVC, Square, Plain Panel /w Single 16" Lattice, 8" @ 12'	\$ 983.89	\$ 924.86
10" COLUMNS	CPSPLS16-10048	CPSPLS16-10048-CF	Column - PVC, Square, Plain Panel /w Single 16" Lattice, 10" @ 4'	\$ 535.03	\$ 502.93
	CPSPLS16-10060	CPSPLS16-10060-CF	Column - PVC, Square, Plain Panel /w Single 16" Lattice, 10" @ 5'	\$ 618.89	\$ 581.75
	CPSPLS16-10072	CPSPLS16-10072-CF	Column - PVC, Square, Plain Panel /w Single 16" Lattice, 10" @ 6'	\$ 673.74	\$ 633.32
	CPSPLS16-10096	CPSPLS16-10096-CF	Column - PVC, Square, Plain Panel /w Single 16" Lattice, 10" @ 8'	\$ 812.46	\$ 763.71
	CPSPLS16-10108	CPSPLS16-10108-CF	Column - PVC, Square, Plain Panel /w Single 16" Lattice, 10" @ 9'	\$ 881.82	\$ 828.91
	CPSPLS16-10120	CPSPLS16-10120-CF	Column - PVC, Square, Plain Panel /w Single 16" Lattice, 10" @ 10'	\$ 951.17	\$ 894.10
	CPSPLS16-10144	CPSPLS16-10144-CF	Column - PVC, Square, Plain Panel /w Single 16" Lattice, 10" @ 12'	\$ 1,090.10	\$ 1,024.69
12" COLUMNS	CPSPLS16-12048	CPSPLS16-12048-CF	Column - PVC, Square, Plain Panel /w Single 16" Lattice, 12" @ 4'	\$ 576.58	\$ 541.98
	CPSPLS16-12060	CPSPLS16-12060-CF	Column - PVC, Square, Plain Panel /w Single 16" Lattice, 12" @ 5'	\$ 668.50	\$ 628.39
	CPSPLS16-12072	CPSPLS16-12072-CF	Column - PVC, Square, Plain Panel /w Single 16" Lattice, 12" @ 6'	\$ 731.43	\$ 687.55
	CPSPLS16-12096	CPSPLS16-12096-CF	Column - PVC, Square, Plain Panel /w Single 16" Lattice, 12" @ 8'	\$ 886.29	\$ 833.12
	CPSPLS16-12108	CPSPLS16-12108-CF	Column - PVC, Square, Plain Panel /w Single 16" Lattice, 12" @ 9'	\$ 963.72	\$ 905.90
	CPSPLS16-12120	CPSPLS16-12120-CF	Column - PVC, Square, Plain Panel /w Single 16" Lattice, 12" @ 10'	\$ 1,041.15	\$ 978.69
	CPSPLS16-12144	CPSPLS16-12144-CF	Column - PVC, Square, Plain Panel /w Single 16" Lattice, 12" @ 12'	\$ 1,196.27	\$ 1,124.49

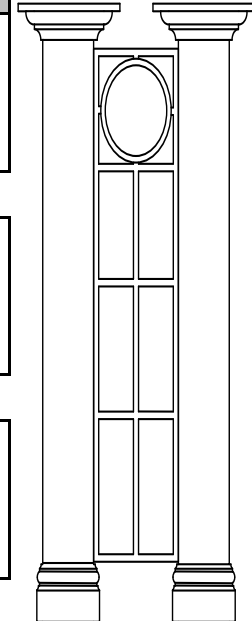

COCHREN FLARE

*12% FOR CUSTOM HEIGHT & 12% FOR ACTUAL WIDTH
 ***FOR COLUMNS LARGER THAN 14" PLEASE CONTACT YOUR LOCAL PRESTIGE DEALER
 **PRICES SUBJECT TO CHANGE WITHOUT NOTICE

SQUARING "L" INCLUDED

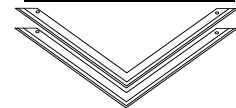

*Add 4" to Outside Dims

SIZE	DIMS OUTSIDE	INSIDE
6"	5-1/2"	4-1/2"
8"	7-1/4"	6-1/4"
10"	9-3/8"	8-3/8"
12"	11-1/2"	10-1/2"
14"	13-1/4"	12-1/4"



(CF) Standard C&B: 5" CRWN CP & 6" TSCN BSE	
CAP	5" Crown Mould
BASE	PVC Tuscan 6"
<input checked="" type="checkbox"/> ADD CAP & BASE	

PRESTIGE COLUMNS - 2018

	PRODUCT CODE / SHAFT ONLY	PRODUCT CODE / STND SKIRTS	DESCRIPTION	1 PIECE	6 PIECE
8" COLUMNS	CPSPLS24-08048	CPSPLS24-08048-CF	Column - PVC, Square, Plain Panel /w Single 24" Lattice, 8" @ 4'	\$ 529.84	\$ 498.05
	CPSPLS24-08060	CPSPLS24-08060-CF	Column - PVC, Square, Plain Panel /w Single 24" Lattice, 8" @ 5'	\$ 627.46	\$ 589.81
	CPSPLS24-08072	CPSPLS24-08072-CF	Column - PVC, Square, Plain Panel /w Single 24" Lattice, 8" @ 6'	\$ 681.52	\$ 640.63
	CPSPLS24-08096	CPSPLS24-08096-CF	Column - PVC, Square, Plain Panel /w Single 24" Lattice, 8" @ 8'	\$ 833.21	\$ 783.22
	CPSPLS24-08108	CPSPLS24-08108-CF	Column - PVC, Square, Plain Panel /w Single 24" Lattice, 8" @ 9'	\$ 800.23	\$ 752.22
	CPSPLS24-08120	CPSPLS24-08120-CF	Column - PVC, Square, Plain Panel /w Single 24" Lattice, 8" @ 10'	\$ 984.90	\$ 925.80
	CPSPLS24-08144	CPSPLS24-08144-CF	Column - PVC, Square, Plain Panel /w Single 24" Lattice, 8" @ 12'	\$ 1,136.75	\$ 1,068.54
10" COLUMNS	CPSPLS24-10048	CPSPLS24-10048-CF	Column - PVC, Square, Plain Panel /w Single 24" Lattice, 10" @ 4'	\$ 571.42	\$ 537.14
	CPSPLS24-10060	CPSPLS24-10060-CF	Column - PVC, Square, Plain Panel /w Single 24" Lattice, 10" @ 5'	\$ 677.11	\$ 636.49
	CPSPLS24-10072	CPSPLS24-10072-CF	Column - PVC, Square, Plain Panel /w Single 24" Lattice, 10" @ 6'	\$ 739.26	\$ 694.90
	CPSPLS24-10096	CPSPLS24-10096-CF	Column - PVC, Square, Plain Panel /w Single 24" Lattice, 10" @ 8'	\$ 907.08	\$ 852.66
	CPSPLS24-10108	CPSPLS24-10108-CF	Column - PVC, Square, Plain Panel /w Single 24" Lattice, 10" @ 9'	\$ 991.00	\$ 931.54
	CPSPLS24-10120	CPSPLS24-10120-CF	Column - PVC, Square, Plain Panel /w Single 24" Lattice, 10" @ 10'	\$ 1,074.91	\$ 1,010.42
	CPSPLS24-10144	CPSPLS24-10144-CF	Column - PVC, Square, Plain Panel /w Single 24" Lattice, 10" @ 12'	\$ 1,242.96	\$ 1,168.38
12" COLUMNS	CPSPLS24-12048	CPSPLS24-12048-CF	Column - PVC, Square, Plain Panel /w Single 24" Lattice, 12" @ 4'	\$ 612.97	\$ 576.19
	CPSPLS24-12060	CPSPLS24-12060-CF	Column - PVC, Square, Plain Panel /w Single 24" Lattice, 12" @ 5'	\$ 726.74	\$ 683.13
	CPSPLS24-12072	CPSPLS24-12072-CF	Column - PVC, Square, Plain Panel /w Single 24" Lattice, 12" @ 6'	\$ 796.94	\$ 749.13
	CPSPLS24-12096	CPSPLS24-12096-CF	Column - PVC, Square, Plain Panel /w Single 24" Lattice, 12" @ 8'	\$ 980.92	\$ 922.06
	CPSPLS24-12108	CPSPLS24-12108-CF	Column - PVC, Square, Plain Panel /w Single 24" Lattice, 12" @ 9'	\$ 1,072.91	\$ 1,008.53
	CPSPLS24-12120	CPSPLS24-12120-CF	Column - PVC, Square, Plain Panel /w Single 24" Lattice, 12" @ 10'	\$ 1,164.89	\$ 1,095.00
	CPSPLS24-12144	CPSPLS24-12144-CF	Column - PVC, Square, Plain Panel /w Single 24" Lattice, 12" @ 12'	\$ 1,349.11	\$ 1,268.17

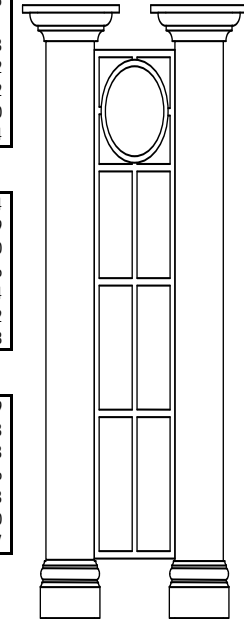

COCHRENF L A R E

*12% FOR CUSTOM HEIGHT & 12% FOR ACTUAL WIDTH
 ***FOR COLUMNS LARGER THAN 14" PLEASE CONTACT YOUR LOCAL PRESTIGE DEALER
 **PRICES SUBJECT TO CHANGE WITHOUT NOTICE

SQUARING "L" INCLUDED



*Add 4" to Outside Dims

SIZE	DIMS OUTSIDE	INSIDE
6"	5-1/2"	4-1/2"
8"	7-1/4"	6-1/4"
10"	9-3/8"	8-3/8"
12"	11-1/2"	10-1/2"
14"	13-1/4"	12-1/4"



(CF) Standard C&B: 5" CRWN CP & 6" TSCN BSE	
CAP	5" Crown Mould
BASE	PVC Tuscan 6"
<input checked="" type="checkbox"/> ADD CAP & BASE	

PRESTIGE COLUMNS - 2018

	PRODUCT CODE / SHAFT ONLY	PRODUCT CODE / STND SKIRTS	DESCRIPTION	1 PIECE	6 PIECE
8" COLUMNS	CPSPLD12-08048	CPSPLD12-08048-CF	Column - PVC, Square, Plain Panel /w Double 12" Lattice, 8" @ 4'	\$ 657.78	\$ 618.31
	CPSPLD12-08060	CPSPLD12-08060-CF	Column - PVC, Square, Plain Panel /w Double 12" Lattice, 8" @ 5'	\$ 779.78	\$ 732.99
	CPSPLD12-08072	CPSPLD12-08072-CF	Column - PVC, Square, Plain Panel /w Double 12" Lattice, 8" @ 6'	\$ 849.54	\$ 798.56
	CPSPLD12-08096	CPSPLD12-08096-CF	Column - PVC, Square, Plain Panel /w Double 12" Lattice, 8" @ 8'	\$ 1,041.30	\$ 978.82
	CPSPLD12-08108	CPSPLD12-08108-CF	Column - PVC, Square, Plain Panel /w Double 12" Lattice, 8" @ 9'	\$ 1,137.83	\$ 1,069.56
	CPSPLD12-08120	CPSPLD12-08120-CF	Column - PVC, Square, Plain Panel /w Double 12" Lattice, 8" @ 10'	\$ 1,233.06	\$ 1,159.08
	CPSPLD12-08144	CPSPLD12-08144-CF	Column - PVC, Square, Plain Panel /w Double 12" Lattice, 8" @ 12'	\$ 1,425.04	\$ 1,339.54
10" COLUMNS	CPSPLD12-10048	CPSPLD12-10048-CF	Column - PVC, Square, Plain Panel /w Double 12" Lattice, 10" @ 4'	\$ 710.71	\$ 668.07
	CPSPLD12-10060	CPSPLD12-10060-CF	Column - PVC, Square, Plain Panel /w Double 12" Lattice, 10" @ 5'	\$ 843.62	\$ 793.00
	CPSPLD12-10072	CPSPLD12-10072-CF	Column - PVC, Square, Plain Panel /w Double 12" Lattice, 10" @ 6'	\$ 924.29	\$ 868.83
	CPSPLD12-10096	CPSPLD12-10096-CF	Column - PVC, Square, Plain Panel /w Double 12" Lattice, 10" @ 8'	\$ 1,137.87	\$ 1,069.60
	CPSPLD12-10108	CPSPLD12-10108-CF	Column - PVC, Square, Plain Panel /w Double 12" Lattice, 10" @ 9'	\$ 1,244.66	\$ 1,169.98
	CPSPLD12-10120	CPSPLD12-10120-CF	Column - PVC, Square, Plain Panel /w Double 12" Lattice, 10" @ 10'	\$ 1,351.44	\$ 1,270.35
	CPSPLD12-10144	CPSPLD12-10144-CF	Column - PVC, Square, Plain Panel /w Double 12" Lattice, 10" @ 12'	\$ 1,565.30	\$ 1,471.38
12" COLUMNS	CPSPLD12-12048	CPSPLD12-12048-CF	Column - PVC, Square, Plain Panel /w Double 12" Lattice, 12" @ 4'	\$ 763.60	\$ 717.78
	CPSPLD12-12060	CPSPLD12-12060-CF	Column - PVC, Square, Plain Panel /w Double 12" Lattice, 12" @ 5'	\$ 907.42	\$ 852.98
	CPSPLD12-12072	CPSPLD12-12072-CF	Column - PVC, Square, Plain Panel /w Double 12" Lattice, 12" @ 6'	\$ 999.00	\$ 939.06
	CPSPLD12-12096	CPSPLD12-12096-CF	Column - PVC, Square, Plain Panel /w Double 12" Lattice, 12" @ 8'	\$ 1,234.38	\$ 1,160.32
	CPSPLD12-12108	CPSPLD12-12108-CF	Column - PVC, Square, Plain Panel /w Double 12" Lattice, 12" @ 9'	\$ 1,352.09	\$ 1,270.96
	CPSPLD12-12120	CPSPLD12-12120-CF	Column - PVC, Square, Plain Panel /w Double 12" Lattice, 12" @ 10'	\$ 1,469.78	\$ 1,381.59
	CPSPLD12-12144	CPSPLD12-12144-CF	Column - PVC, Square, Plain Panel /w Double 12" Lattice, 12" @ 12'	\$ 1,705.51	\$ 1,603.18

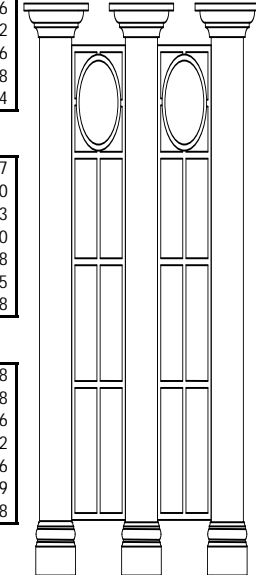

COCHREN FLARE

*12% FOR CUSTOM HEIGHT & 12% FOR ACTUAL WIDTH
 ***FOR COLUMNS LARGER THAN 14" PLEASE CONTACT YOUR LOCAL PRESTIGE DEALER
 **PRICES SUBJECT TO CHANGE WITHOUT NOTICE

SQUARING "L" INCLUDED

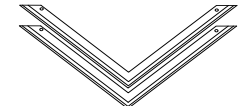

*Add 4" to Outside Dims

	DIMS	
SIZE	OUTSIDE	INSIDE
6"	5-1/2"	4-1/2"
8"	7-1/4"	6-1/4"
10"	9-3/8"	8-3/8"
12"	11-1/2"	10-1/2"
14"	13-1/4"	12-1/4"



(CF)Standard C&B: 5" CRWN CP & 6" TSCN BSE	
CAP	5" Crown Mould
BASE	PVC Tuscan 6"
<input checked="" type="checkbox"/> ADD CAP & BASE	

PRESTIGE COLUMNS - 2018

	PRODUCT CODE / SHAFT ONLY	PRODUCT CODE / STND. SKIRTS	DESCRIPTION	1 PIECE	6 PIECE
8" COLUMNS	CPSPLD16-08048	CPSPLD16-08048-CF	Column - PVC, Square, Plain Panel /w Double 16" Lattice, 8" @ 4'	\$ 657.78	\$ 618.31
	CPSPLD16-08060	CPSPLD16-08060	Column - PVC, Square, Plain Panel /w Double 16" Lattice, 8" @ 5'	\$ 779.78	\$ 732.99
	CPSPLD16-08072	CPSPLD16-08072	Column - PVC, Square, Plain Panel /w Double 16" Lattice, 8" @ 6'	\$ 849.54	\$ 798.56
	CPSPLD16-08096	CPSPLD16-08096	Column - PVC, Square, Plain Panel /w Double 16" Lattice, 8" @ 8'	\$ 1,041.30	\$ 978.82
	CPSPLD16-08108	CPSPLD16-08108	Column - PVC, Square, Plain Panel /w Double 16" Lattice, 8" @ 9'	\$ 1,137.83	\$ 1,069.56
	CPSPLD16-08120	CPSPLD16-08120	Column - PVC, Square, Plain Panel /w Double 16" Lattice, 8" @ 10'	\$ 1,233.06	\$ 1,159.08
	CPSPLD16-08144	CPSPLD16-08144	Column - PVC, Square, Plain Panel /w Double 16" Lattice, 8" @ 12'	\$ 1,425.04	\$ 1,339.54
10" COLUMNS	CPSPLD16-10048	CPSPLD16-10048	Column - PVC, Square, Plain Panel /w Double 16" Lattice, 10" @ 4'	\$ 710.71	\$ 668.07
	CPSPLD16-10060	CPSPLD16-10060	Column - PVC, Square, Plain Panel /w Double 16" Lattice, 10" @ 5'	\$ 843.62	\$ 793.00
	CPSPLD16-10072	CPSPLD16-10072	Column - PVC, Square, Plain Panel /w Double 16" Lattice, 10" @ 6'	\$ 924.29	\$ 868.83
	CPSPLD16-10096	CPSPLD16-10096	Column - PVC, Square, Plain Panel /w Double 16" Lattice, 10" @ 8'	\$ 1,137.87	\$ 1,069.60
	CPSPLD16-10108	CPSPLD16-10108	Column - PVC, Square, Plain Panel /w Double 16" Lattice, 10" @ 9'	\$ 1,244.66	\$ 1,169.98
	CPSPLD16-10120	CPSPLD16-10120	Column - PVC, Square, Plain Panel /w Double 16" Lattice, 10" @ 10'	\$ 1,351.44	\$ 1,270.35
	CPSPLD16-10144	CPSPLD16-10144	Column - PVC, Square, Plain Panel /w Double 16" Lattice, 10" @ 12'	\$ 1,565.30	\$ 1,471.38
12" COLUMNS	CPSPLD16-12048	CPSPLD16-12048	Column - PVC, Square, Plain Panel /w Double 16" Lattice, 12" @ 4'	\$ 763.60	\$ 717.78
	CPSPLD16-12060	CPSPLD16-12060	Column - PVC, Square, Plain Panel /w Double 16" Lattice, 12" @ 5'	\$ 907.42	\$ 852.98
	CPSPLD16-12072	CPSPLD16-12072	Column - PVC, Square, Plain Panel /w Double 16" Lattice, 12" @ 6'	\$ 999.00	\$ 939.06
	CPSPLD16-12096	CPSPLD16-12096	Column - PVC, Square, Plain Panel /w Double 16" Lattice, 12" @ 8'	\$ 1,234.38	\$ 1,160.32
	CPSPLD16-12108	CPSPLD16-12108	Column - PVC, Square, Plain Panel /w Double 16" Lattice, 12" @ 9'	\$ 1,352.09	\$ 1,270.96
	CPSPLD16-12120	CPSPLD16-12120	Column - PVC, Square, Plain Panel /w Double 16" Lattice, 12" @ 10'	\$ 1,469.78	\$ 1,381.59
	CPSPLD16-12144	CPSPLD16-12144	Column - PVC, Square, Plain Panel /w Double 16" Lattice, 12" @ 12'	\$ 1,705.51	\$ 1,603.18

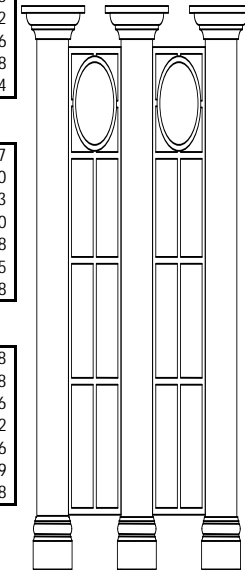

COCHRAN FLARE

*12% FOR CUSTOM HEIGHT & 12% FOR ACTUAL WIDTH
 ***FOR COLUMNS LARGER THAN 14" PLEASE CONTACT YOUR LOCAL PRESTIGE DEALER
 **PRICES SUBJECT TO CHANGE WITHOUT NOTICE

SQUARING "L" INCLUDED



*Add 4" to Outside Dims

	DIMS	
SIZE	OUTSIDE	INSIDE
6"	5-1/2"	4-1/2"
8"	7-1/4"	6-1/4"
10"	9-3/8"	8-3/8"
12"	11-1/2"	10-1/2"
14"	13-1/4"	12-1/4"



(CF) Standard C&B: 5" CRWN CP & 6" TSCN BSE	
CAP	5" Crown Mould
BASE	PVC Tuscan 6"
<input checked="" type="checkbox"/> ADD CAP & BASE	

PRESTIGE COLUMNS - 2018

	PRODUCT CODE / SHAFT ONLY	PRODUCT CODE / STND SKIRTS	DESCRIPTION	1 PIECE	6 PIECE
8" COLUMNS	CPSPLD24-08048	CPSPLD24-08048-CF	Column - PVC, Square, Plain Panel /w Double 24" Lattice, 8" @ 4'	\$ 723.36	\$ 679.95
	CPSPLD24-08060	CPSPLD24-08060	Column - PVC, Square, Plain Panel /w Double 24" Lattice, 8" @ 5'	\$ 884.70	\$ 831.62
	CPSPLD24-08072	CPSPLD24-08072	Column - PVC, Square, Plain Panel /w Double 24" Lattice, 8" @ 6'	\$ 967.57	\$ 909.52
	CPSPLD24-08096	CPSPLD24-08096	Column - PVC, Square, Plain Panel /w Double 24" Lattice, 8" @ 8'	\$ 1,211.79	\$ 1,139.08
	CPSPLD24-08108	CPSPLD24-08108	Column - PVC, Square, Plain Panel /w Double 24" Lattice, 8" @ 9'	\$ 1,137.83	\$ 1,069.56
	CPSPLD24-08120	CPSPLD24-08120	Column - PVC, Square, Plain Panel /w Double 24" Lattice, 8" @ 10'	\$ 1,456.01	\$ 1,368.65
	CPSPLD24-08144	CPSPLD24-08144	Column - PVC, Square, Plain Panel /w Double 24" Lattice, 8" @ 12'	\$ 1,700.45	\$ 1,598.43
10" COLUMNS	CPSPLD24-10048	CPSPLD24-10048	Column - PVC, Square, Plain Panel /w Double 24" Lattice, 10" @ 4'	\$ 776.28	\$ 729.71
	CPSPLD24-10060	CPSPLD24-10060	Column - PVC, Square, Plain Panel /w Double 24" Lattice, 10" @ 5'	\$ 948.54	\$ 891.63
	CPSPLD24-10072	CPSPLD24-10072	Column - PVC, Square, Plain Panel /w Double 24" Lattice, 10" @ 6'	\$ 1,042.32	\$ 979.79
	CPSPLD24-10096	CPSPLD24-10096	Column - PVC, Square, Plain Panel /w Double 24" Lattice, 10" @ 8'	\$ 1,308.36	\$ 1,229.86
	CPSPLD24-10108	CPSPLD24-10108	Column - PVC, Square, Plain Panel /w Double 24" Lattice, 10" @ 9'	\$ 1,441.37	\$ 1,354.89
	CPSPLD24-10120	CPSPLD24-10120	Column - PVC, Square, Plain Panel /w Double 24" Lattice, 10" @ 10'	\$ 1,574.39	\$ 1,479.93
	CPSPLD24-10144	CPSPLD24-10144	Column - PVC, Square, Plain Panel /w Double 24" Lattice, 10" @ 12'	\$ 1,840.71	\$ 1,730.27
12" COLUMNS	CPSPLD24-12048	CPSPLD24-12048	Column - PVC, Square, Plain Panel /w Double 24" Lattice, 12" @ 4'	\$ 829.17	\$ 779.42
	CPSPLD24-12060	CPSPLD24-12060	Column - PVC, Square, Plain Panel /w Double 24" Lattice, 12" @ 5'	\$ 1,012.34	\$ 951.60
	CPSPLD24-12072	CPSPLD24-12072	Column - PVC, Square, Plain Panel /w Double 24" Lattice, 12" @ 6'	\$ 1,117.03	\$ 1,050.00
	CPSPLD24-12096	CPSPLD24-12096	Column - PVC, Square, Plain Panel /w Double 24" Lattice, 12" @ 8'	\$ 1,404.88	\$ 1,320.58
	CPSPLD24-12108	CPSPLD24-12108	Column - PVC, Square, Plain Panel /w Double 24" Lattice, 12" @ 9'	\$ 1,548.81	\$ 1,455.88
	CPSPLD24-12120	CPSPLD24-12120	Column - PVC, Square, Plain Panel /w Double 24" Lattice, 12" @ 10'	\$ 1,692.74	\$ 1,591.17
	CPSPLD24-12144	CPSPLD24-12144	Column - PVC, Square, Plain Panel /w Double 24" Lattice, 12" @ 12'	\$ 1,980.92	\$ 1,862.07

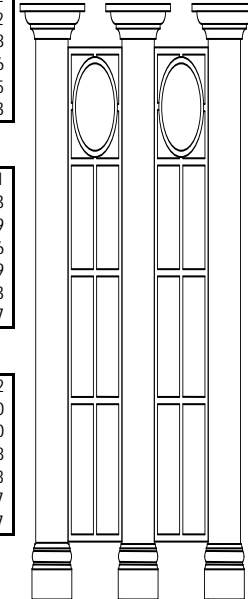

C
O
C
H
R
E
N

F
L
A
R
E

*12% FOR CUSTOM HEIGHT & 12% FOR ACTUAL WIDTH

***FOR COLUMNS LARGER THAN 14" PLEASE CONTACT YOUR LOCAL PRESTIGE DEALER

**PRICES SUBJECT TO CHANGE WITHOUT NOTICE

SQUARING "L" INCLUDED



*Add 4" to Outside Dims

DIMS

SIZE	OUTSIDE	INSIDE
6"	5-1/2"	4-1/2"
8"	7-1/4"	6-1/4"
10"	9-3/8"	8-3/8"
12"	11-1/2"	10-1/2"
14"	13-1/4"	12-1/4"



(CT) Standard C&B: Contemporary 4" Cap & 6" Base	
CAP	4" Contemporary (4/4)
BASE	6" Contemporary (4/4)
* ADD CAP & BASE	

PRESTIGE COLUMNS - 2018

	PRODUCT CODE	PRODUCT CODE / w CONTEMP SKIRTS	DESCRIPTION	1 PIECE	6 PIECE
8" COLUMNS	CPST1-08048	CPST1-08048-CT	Column - PVC, Square, Contemporary Flare #1 Plain Panel, 8" @ 4'	\$ 242.69	\$ 228.13
	CPST1-08060	CPST1-08060-CT	Column - PVC, Square, Contemporary Flare #1 Plain Panel, 8" @ 5'	\$ 258.99	\$ 243.45
	CPST1-08072	CPST1-08072-CT	Column - PVC, Square, Contemporary Flare #1 Plain Panel, 8" @ 6'	\$ 275.29	\$ 258.77
	CPST1-08096	CPST1-08096-CT	Column - PVC, Square, Contemporary Flare #1 Plain Panel, 8" @ 8'	\$ 307.88	\$ 289.41
	CPST1-08108	CPST1-08108-CT	Column - PVC, Square, Contemporary Flare #1 Plain Panel, 8" @ 9'	\$ 324.17	\$ 304.72
	CPST1-08120	CPST1-08120-CT	Column - PVC, Square, Contemporary Flare #1 Plain Panel, 8" @ 10'	\$ 340.47	\$ 320.04
	CPST1-08144	CPST1-08144-CT	Column - PVC, Square, Contemporary Flare #1 Plain Panel, 8" @ 12'	\$ 373.15	\$ 350.76
10" COLUMNS	CPST1-10048	CPST1-10048-CT	Column - PVC, Square, Contemporary Flare #1 Plain Panel, 10" @ 4'	\$ 267.18	\$ 251.15
	CPST1-10060	CPST1-10060-CT	Column - PVC, Square, Contemporary Flare #1 Plain Panel, 10" @ 5'	\$ 287.55	\$ 270.30
	CPST1-10072	CPST1-10072-CT	Column - PVC, Square, Contemporary Flare #1 Plain Panel, 10" @ 6'	\$ 307.93	\$ 289.45
	CPST1-10096	CPST1-10096-CT	Column - PVC, Square, Contemporary Flare #1 Plain Panel, 10" @ 8'	\$ 348.66	\$ 327.74
	CPST1-10108	CPST1-10108-CT	Column - PVC, Square, Contemporary Flare #1 Plain Panel, 10" @ 9'	\$ 369.03	\$ 346.89
	CPST1-10120	CPST1-10120-CT	Column - PVC, Square, Contemporary Flare #1 Plain Panel, 10" @ 10'	\$ 389.39	\$ 366.03
	CPST1-10144	CPST1-10144-CT	Column - PVC, Square, Contemporary Flare #1 Plain Panel, 10" @ 12'	\$ 430.24	\$ 404.43
12" COLUMNS	CPST1-12048	CPST1-12048-CT	Column - PVC, Square, Contemporary Flare #1 Plain Panel, 12" @ 4'	\$ 291.67	\$ 274.17
	CPST1-12060	CPST1-12060-CT	Column - PVC, Square, Contemporary Flare #1 Plain Panel, 12" @ 5'	\$ 316.11	\$ 297.15
	CPST1-12072	CPST1-12072-CT	Column - PVC, Square, Contemporary Flare #1 Plain Panel, 12" @ 6'	\$ 340.55	\$ 320.12
	CPST1-12096	CPST1-12096-CT	Column - PVC, Square, Contemporary Flare #1 Plain Panel, 12" @ 8'	\$ 389.44	\$ 366.07
	CPST1-12108	CPST1-12108-CT	Column - PVC, Square, Contemporary Flare #1 Plain Panel, 12" @ 9'	\$ 413.88	\$ 389.05
	CPST1-12120	CPST1-12120-CT	Column - PVC, Square, Contemporary Flare #1 Plain Panel, 12" @ 10'	\$ 438.33	\$ 412.03
	CPST1-12144	CPST1-12144-CT	Column - PVC, Square, Contemporary Flare #1 Plain Panel, 12" @ 12'	\$ 487.34	\$ 458.10
14" COLUMNS	CPST1-14048	CPST1-14048-CT	Column - PVC, Square, Contemporary Flare #1 Plain Panel, 14" @ 4'	\$ 339.22	\$ 318.87
	CPST1-14060	CPST1-14060-CT	Column - PVC, Square, Contemporary Flare #1 Plain Panel, 14" @ 5'	\$ 341.60	\$ 321.11
	CPST1-14072	CPST1-14072-CT	Column - PVC, Square, Contemporary Flare #1 Plain Panel, 14" @ 6'	\$ 370.11	\$ 347.91
	CPST1-14096	CPST1-14096-CT	Column - PVC, Square, Contemporary Flare #1 Plain Panel, 14" @ 8'	\$ 427.15	\$ 401.52
	CPST1-14108	CPST1-14108-CT	Column - PVC, Square, Contemporary Flare #1 Plain Panel, 14" @ 9'	\$ 455.66	\$ 428.32
	CPST1-14120	CPST1-14120-CT	Column - PVC, Square, Contemporary Flare #1 Plain Panel, 14" @ 10'	\$ 484.18	\$ 455.13
	CPST1-14144	CPST1-14144-CT	Column - PVC, Square, Contemporary Flare #1 Plain Panel, 14" @ 12'	\$ 541.36	\$ 508.88

CONTEMPORARY FLARE # 1

* 12% FOR CUSTOM HEIGHT & 12% FOR ACTUAL WIDTH
 ***FOR COLUMNS LARGER THAN 14" PLEASE CONTACT YOUR LOCAL PRESTIGE DEALER
 **PRICES SUBJECT TO CHANGE WITHOUT NOTICE

DIMS	SIZE	OUTSIDE	INSIDE
	8"	7-1/4"	6-1/4"
	10"	9-3/8"	8-3/8"
	12"	11-1/2"	10-1/2"
	14"	13-1/4"	12-1/4"



*Add 4" to Outside Dim's

PRESTIGE COLUMNS - 2018

	PRODUCT CODE	PRODUCT CODE / w CONTEMP SKIRTS	DESCRIPTION	1 PIECE	6 PIECE
8" COLUMNS	CPST2-08048	CPST2-08048-CT	Column - PVC, Square, Contemporary Flare #2 Grooved Panel, 8" @ 4'	\$ 256.05	\$ 240.69
	CPST2-08060	CPST2-08060-CT	Column - PVC, Square, Contemporary Flare #2 Grooved Panel, 8" @ 5'	\$ 275.85	\$ 259.30
	CPST2-08072	CPST2-08072-CT	Column - PVC, Square, Contemporary Flare #2 Grooved Panel, 8" @ 6'	\$ 295.65	\$ 277.91
	CPST2-08096	CPST2-08096-CT	Column - PVC, Square, Contemporary Flare #2 Grooved Panel, 8" @ 8'	\$ 335.26	\$ 315.14
	CPST2-08108	CPST2-08108-CT	Column - PVC, Square, Contemporary Flare #2 Grooved Panel, 8" @ 9'	\$ 355.06	\$ 333.76
	CPST2-08120	CPST2-08120-CT	Column - PVC, Square, Contemporary Flare #2 Grooved Panel, 8" @ 10'	\$ 374.87	\$ 352.37
	CPST2-08144	CPST2-08144-CT	Column - PVC, Square, Contemporary Flare #2 Grooved Panel, 8" @ 12'	\$ 414.47	\$ 389.60
10" COLUMNS	CPST2-10048	CPST2-10048-CT	Column - PVC, Square, Contemporary Flare #2 Grooved Panel, 10" @ 4'	\$ 284.85	\$ 267.76
	CPST2-10060	CPST2-10060-CT	Column - PVC, Square, Contemporary Flare #2 Grooved Panel, 10" @ 5'	\$ 309.85	\$ 291.26
	CPST2-10072	CPST2-10072-CT	Column - PVC, Square, Contemporary Flare #2 Grooved Panel, 10" @ 6'	\$ 334.85	\$ 314.76
	CPST2-10096	CPST2-10096-CT	Column - PVC, Square, Contemporary Flare #2 Grooved Panel, 10" @ 8'	\$ 384.85	\$ 361.76
	CPST2-10108	CPST2-10108-CT	Column - PVC, Square, Contemporary Flare #2 Grooved Panel, 10" @ 9'	\$ 409.85	\$ 385.26
	CPST2-10120	CPST2-10120-CT	Column - PVC, Square, Contemporary Flare #2 Grooved Panel, 10" @ 10'	\$ 434.86	\$ 408.76
	CPST2-10144	CPST2-10144-CT	Column - PVC, Square, Contemporary Flare #2 Grooved Panel, 10" @ 12'	\$ 484.86	\$ 455.77
12" COLUMNS	CPST2-12048	CPST2-12048-CT	Column - PVC, Square, Contemporary Flare #2 Grooved Panel, 12" @ 4'	\$ 314.03	\$ 295.19
	CPST2-12060	CPST2-12060-CT	Column - PVC, Square, Contemporary Flare #2 Grooved Panel, 12" @ 5'	\$ 344.33	\$ 323.67
	CPST2-12072	CPST2-12072-CT	Column - PVC, Square, Contemporary Flare #2 Grooved Panel, 12" @ 6'	\$ 374.63	\$ 352.15
	CPST2-12096	CPST2-12096-CT	Column - PVC, Square, Contemporary Flare #2 Grooved Panel, 12" @ 8'	\$ 435.23	\$ 409.11
	CPST2-12108	CPST2-12108-CT	Column - PVC, Square, Contemporary Flare #2 Grooved Panel, 12" @ 9'	\$ 465.53	\$ 437.59
	CPST2-12120	CPST2-12120-CT	Column - PVC, Square, Contemporary Flare #2 Grooved Panel, 12" @ 10'	\$ 495.82	\$ 466.08
	CPST2-12144	CPST2-12144-CT	Column - PVC, Square, Contemporary Flare #2 Grooved Panel, 12" @ 12'	\$ 556.42	\$ 523.04
14" COLUMNS	CPST2-14048	CPST2-14048-CT	Column - PVC, Square, Contemporary Flare #2 Grooved Panel, 14" @ 4'	\$ 370.76	\$ 348.51
	CPST2-14060	CPST2-14060-CT	Column - PVC, Square, Contemporary Flare #2 Grooved Panel, 14" @ 5'	\$ 381.52	\$ 358.63
	CPST2-14072	CPST2-14072-CT	Column - PVC, Square, Contemporary Flare #2 Grooved Panel, 14" @ 6'	\$ 418.43	\$ 393.33
	CPST2-14096	CPST2-14096-CT	Column - PVC, Square, Contemporary Flare #2 Grooved Panel, 14" @ 8'	\$ 492.25	\$ 462.71
	CPST2-14108	CPST2-14108-CT	Column - PVC, Square, Contemporary Flare #2 Grooved Panel, 14" @ 9'	\$ 529.16	\$ 497.41
	CPST2-14120	CPST2-14120-CT	Column - PVC, Square, Contemporary Flare #2 Grooved Panel, 14" @ 10'	\$ 566.06	\$ 532.10
	CPST2-14144	CPST2-14144-CT	Column - PVC, Square, Contemporary Flare #2 Grooved Panel, 14" @ 12'	\$ 639.88	\$ 601.49

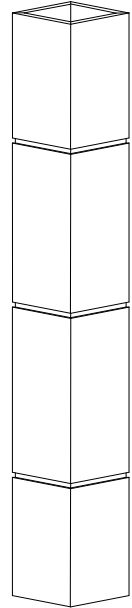

CONTEMPORARY FLARE # 2

*12% FOR CUSTOM HEIGHT & 12% FOR ACTUAL WIDTH
 ***FOR COLUMNS LARGER THAN 14" PLEASE CONTACT YOUR LOCAL PRESTIGE DEALER
 **PRICES SUBJECT TO CHANGE WITHOUT NOTICE

DIMS	SIZE	OUTSIDE	INSIDE
	8"	7-1/4"	5-3/4"
	10"	9-3/8"	7-7/8"
	12"	11-1/2"	10"
	14"	13-1/4"	11-3/4"

SQUARING "L" INCLUDED



*Add 4" to Outside Dims



PRESTIGE SOFFIT - 2018

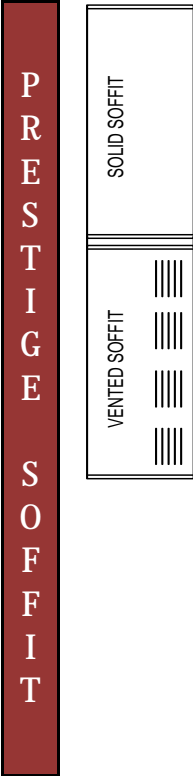

	PRODUCT CODE	DESCRIPTION	NATURAL FINISH		PRE-FINISHED		STAINED	
			PER PIECE PRICE	PER BOX PRICE	PER PIECE PRICE	PER BOX PRICE	PER PIECE PRICE	PER BOX PRICE
SOLID SOFFIT	PSFS1212-48	Soffit - PVC, Solid - 1/2" x 12" x 48" /w Easy Fit System	\$ 32.09	\$ 194.35	\$ 41.72	\$ 252.65	\$ 46.53	\$ 281.80
	PSFS1216-48	Soffit - PVC, Solid - 1/2" x 16" x 48" /w Easy Fit System	\$ 37.69	\$ 227.93	\$ 48.99	\$ 296.30	\$ 54.65	\$ 330.49
	PSFS1224-48	Soffit - PVC, Solid - 1/2" x 24" x 48" /w Easy Fit System	\$ 54.80	\$ 330.56	\$ 71.23	\$ 429.72	\$ 79.45	\$ 479.30
<i>*SOLD IN BOXES OF 6PCS</i>								
VENTED SOFFIT	PSFV1212-48	Soffit - PVC, Vented - 1/2" x 12" x 48" /w Easy Fit System	\$ 42.41	\$ 256.22	\$ 55.13	\$ 333.09	\$ 61.49	\$ 371.52
	PSFV1216-48	Soffit - PVC, Vented - 1/2" x 16" x 48" /w Easy Fit System	\$ 48.00	\$ 289.80	\$ 62.40	\$ 376.74	\$ 69.60	\$ 420.21
	PSFV1224-48	Soffit - PVC, Vented - 1/2" x 24" x 48" /w Easy Fit System	\$ 66.35	\$ 399.86	\$ 86.25	\$ 519.81	\$ 96.20	\$ 579.79
<i>*SOLD IN BOXES OF 6PCS</i>								
SOFFIT KITS	PSFS1212-K5C	Soffit - PVC - Kit - 5pcs Vented Soffit 1/2" x 12" x 48", 2pcs Corner Panel & 1pc 4' Spline		\$ 345.92		\$ 449.70		\$ 501.59
	PSFS1216-K5C	Soffit - PVC - Kit - 5pcs Vented Soffit 1/2" x 16" x 48", 2pcs Corner Panel & 1pc 4' Spline		\$ 392.56		\$ 510.32		\$ 569.21
	PSFS1224-K5C	Soffit - PVC - Kit - 5pcs Vented Soffit 1/2" x 24" x 48", 2pcs Corner Panel & 1pc 4' Spline		\$ 478.50		\$ 622.05		\$ 693.83
<i>*SOLD IN BOXES OF 8PCS</i>								
TRANSITION CORNERS	PSFC1212-12	Soffit - PVC, Solid - 1/2" x 12" x 12" /w Easy Fit System	\$ 15.76		\$ 20.48		\$ 22.85	
	PSFC1216-16	Soffit - PVC, Solid - 1/2" x 16" x 16" /w Easy Fit System	\$ 19.04		\$ 24.76		\$ 27.61	
	PSFC1224-16	Soffit - PVC, Solid - 1/2" x 24" x 16" /w Easy Fit System	\$ 23.12		\$ 30.06		\$ 33.53	
INSERT MOULD	PSTM-48	Soffit - PVC, "Spline" 1/4" x 2" x 48"	\$ 9.78		\$ 12.71		\$ 14.18	

****PRICES SUBJECT TO CHANGE WITHOUT NOTICE**

Add *Prestige*
to
Your Home

The *Prestige* Advantage

Beautiful

- Classic Architectural Shutter Look
- Various Louver and Panel Dimensions
- Minimal Visible Fasteners
- Custom Panel Detailing Available

Easy Installation

- Complete Kit, with Fasteners & Hanging Template
- No Special Tools Needed
- Flat-Pack for Safe & Easy Transportation

Virtually Maintenance Free

- Free-Foam Cellular PVC Construction
- Weather, Decay and Insect Resistant
- Easy to Clean
- Painting NOT Required
- Paint Friendly with Acrylic Latex Paints



Custom Sizes are available
Warranty: 30 year limited
warranty - warranty information
available at
www.decorinnovations.ca



Innovative PVC Systems



For More Information on Prestige Shutters or other Prestige products, please visit us at
www.decorinnovations.ca or contact us at 289-291-9006

PRESTIGE PVC SHUTTER POLICIES

- 1 Once an order has been placed , it is non-cancelable and non-returnable.
- 2 Only complete orders will be accepted.
 - Partial orders that are missing key information such as: colour, size, ship to location, etc. Will not be accepted
 - Changes Will not be accepted once original order has been allocated for manufacturing
 - Changes Will be accepted prior to allocation. The original order Will be cancelled and The Changes Will be entered as a new order with a new ship date
- 3 Decor/Distinctive Collections are designed with "key hole" hanging system and come with fasteners for HANGING (NO FACE DAMAGE NESSACCARY BY USE OF SCREWS THROUGH FINISHED FACE)

Prices do not include Hardware (see collection tabs to add hardware)
 - for hardware options and pricing please see The hardware tab
 - Shutters from 12" to 48" in height require the use of 2 Hinges
 - Shutters from 49" to 96" in height require the use of 3 Hinges
 - Shutters from 97" to 144" in height require the use of 4 Hinges
 - Shutters over 144" in height require the use of 5 Hinges
- 4 Prices do not include freight. All products are F.O.B Oakville, Ontario
 - Additional charges may apply for shipments outside of Canada, to residential addresses/locations or construction sites
 - Additional charges may apply for special requests on shipping, packaging & delivery
- 5 Prices reflect the price per pair
- 6 Pricing for a single shutter will half the price of a shutter pair, Design options will receive the entire per pair price
- 7 Pricing is based on 6 standard colours
 - a one time \$150 fee will assessed for all custom colour requests with a minimum of 1 Gallon
 - a primed finish option is available on all Shutters
- 8 Shutter heights and widths are available in 1/8" increments
- 9 Heights at less than 30" are priced at a 30" minimum
- 10 All product needs to be inspected immediately upon receipt of delivery
Freight damage claims received after 12 days of receipt of delivery will result in No Credit
- 11 Shutter sizes exceeding 90" in length or width will have an additional freight charge please contact your sales rep for quotation
- 12 Special shipping crate may be required for oversize shipments and/or any orders shipped outside of Ontario. An additional freight charge please contact your sales rep for quotation

SHUTTER HARDWARE - 2018



SHUTTER HARDWARE



DESCRIPTION
<ul style="list-style-type: none"> - 12" Hinge Arm - Sold in pairs, 2 pairs per window - Offsets available: 0", 1", 2" & 3" - Sold in pairs - Stainless Steel

PRICE	QUANTITY NEEDED	TOTAL
\$ 87.61	0	\$ -



<ul style="list-style-type: none"> - Sets of 4 Hinges /w 4 Pintels - 6 3/4"w x 5"h - Strengthens corners of the shutter - Offsets available: 0", 1 1/2" & 2 1/8" - Cast Iron construction /w rust resistant paint
--

\$ 314.75	0	\$ -
-----------	---	------

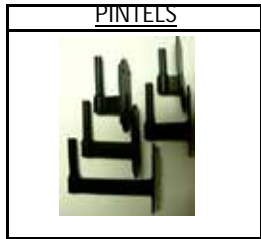

<ul style="list-style-type: none"> - Sold in pairs (2 pairs per window) - Offsets available: 1/2", 1 1/2" & 2 1/4" - Stainless Steel

\$ 103.83	0	\$ -
-----------	---	------



<ul style="list-style-type: none"> - 7" Tall with 4" Lag - Sold in pairs - Stainless Steel

\$ 133.04	0	\$ -
-----------	---	------

SELECTION TOTAL	\$ -	
-----------------	------	--

**PRICES SUBJECT TO CHANGE WITHOUT NOTICE



DECOR COLLECTION SHUTTERS - 2018



RAISED PANEL SX(R)R(2)

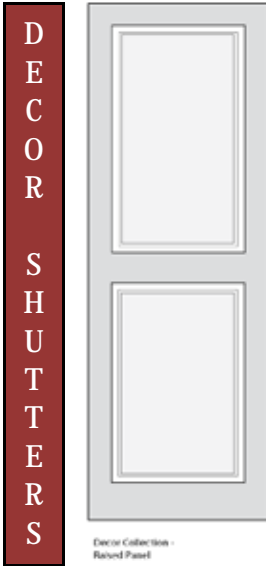

		WIDTH										
		12	14	16	18	20	22	24	26	28	30	32
H E I G H T	24	\$ 99.82	\$ 116.45	\$ 133.08	\$ 149.72	\$ 166.36	\$ 182.99	\$ 199.62	\$ 216.26	\$ 232.90	\$ 249.53	\$ 266.16
	30	\$ 124.77	\$ 145.56	\$ 166.36	\$ 187.14	\$ 207.94	\$ 228.74	\$ 249.53	\$ 270.33	\$ 291.11	\$ 311.91	\$ 332.71
	36	\$ 149.72	\$ 174.67	\$ 199.62	\$ 224.57	\$ 249.53	\$ 274.48	\$ 299.44	\$ 324.39	\$ 349.34	\$ 374.30	\$ 399.25
	42	\$ 174.67	\$ 203.79	\$ 232.90	\$ 262.01	\$ 291.11	\$ 320.23	\$ 349.34	\$ 378.45	\$ 407.56	\$ 436.68	\$ 465.79
	48	\$ 199.62	\$ 232.90	\$ 266.16	\$ 299.44	\$ 332.71	\$ 365.98	\$ 399.25	\$ 432.52	\$ 465.79	\$ 499.06	\$ 532.33
	54	\$ 224.57	\$ 262.01	\$ 299.44	\$ 336.87	\$ 374.30	\$ 411.73	\$ 449.16	\$ 486.58	\$ 524.01	\$ 561.44	\$ 598.87
	60	\$ 249.53	\$ 291.11	\$ 332.71	\$ 374.30	\$ 415.88	\$ 457.47	\$ 499.06	\$ 540.65	\$ 582.24	\$ 623.83	\$ 665.41
	66	\$ 274.48	\$ 320.23	\$ 365.98	\$ 411.73	\$ 457.47	\$ 503.22	\$ 548.96	\$ 594.72	\$ 640.46	\$ 686.21	\$ 731.95
	72	\$ 299.44	\$ 349.34	\$ 399.25	\$ 449.16	\$ 499.06	\$ 548.96	\$ 598.87	\$ 648.78	\$ 698.69	\$ 748.59	\$ 798.49
	78	\$ 324.39	\$ 378.45	\$ 432.52	\$ 486.58	\$ 540.65	\$ 594.72	\$ 648.78	\$ 702.84	\$ 756.91	\$ 810.97	\$ 865.04
	84	\$ 349.34	\$ 407.56	\$ 465.79	\$ 524.01	\$ 582.24	\$ 640.46	\$ 698.69	\$ 756.91	\$ 815.13	\$ 873.35	\$ 931.58
	90	\$ 374.30	\$ 436.68	\$ 499.06	\$ 561.44	\$ 623.83	\$ 686.21	\$ 748.59	\$ 810.97	\$ 873.35	\$ 935.74	\$ 998.12
	96	\$ 399.25	\$ 465.79	\$ 532.33	\$ 598.87	\$ 665.41	\$ 731.95	\$ 798.49	\$ 865.04	\$ 931.58	\$ 998.12	\$ 1,064.66
	102	\$ 424.20	\$ 494.90	\$ 565.61	\$ 636.30	\$ 707.00	\$ 777.70	\$ 848.40	\$ 919.11	\$ 989.80	\$ 1,060.51	\$ 1,131.20
	108	\$ 449.16	\$ 524.01	\$ 598.87	\$ 673.73	\$ 748.59	\$ 823.45	\$ 898.31	\$ 973.17	\$ 1,048.03	\$ 1,122.88	\$ 1,197.74
114	\$ 474.10	\$ 553.13	\$ 632.15	\$ 711.16	\$ 790.18	\$ 869.20	\$ 948.21	\$ 1,027.23	\$ 1,106.25	\$ 1,185.27	\$ 1,264.28	
120	\$ 499.06	\$ 582.24	\$ 665.41	\$ 748.59	\$ 831.77	\$ 914.94	\$ 998.12	\$ 1,081.30	\$ 1,164.48	\$ 1,247.65	\$ 1,330.82	

**PRICES SUBJECT TO CHANGE WITHOUT NOTICE

SHUTTER OPTIONS		SELECT	SELECTED OPTIONS
FRAMES	SINGLE PANEL (1) - 5% Upcharge	<input type="checkbox"/>	
	TRIPLE PANEL(3) - 10% Upcharge	<input type="checkbox"/>	
	CUSTOM RAIL (9) - 15% Upcharge	<input type="checkbox"/>	
	CUSTOM SHUTTER DETAIL - 25% Upcharge	<input type="checkbox"/>	
	ARCHED TOP (A) - 25% Upcharge	<input type="checkbox"/>	
PRICING INSTRUCTIONS			\$ -
ENTER PRICE INTO BLUE CELL			
HANGING OPTIONS:	FLUSH MOUNT (WOOD/SIDING) INCLUDED	<input type="checkbox"/>	
	FACE MOUNT (CONCRETE/BRICK)	<input type="checkbox"/>	
	HINGES (SEE HARDWARE PAGE)	<input type="checkbox"/>	
HARDWARE PAGE LINK			
		TOTAL	\$ -

*Sold in Pairs
 **Prices reflect double panel shutters with even sized panels.
 *Prices subject to change without notice

SXRR3-1696 - Shutter,PVC- Decor Raised Triple Panel, 16"W x 96"H



DECOR COLLECTION SHUTTERS - 2018



RECESSED PANEL SX(R)F(2)

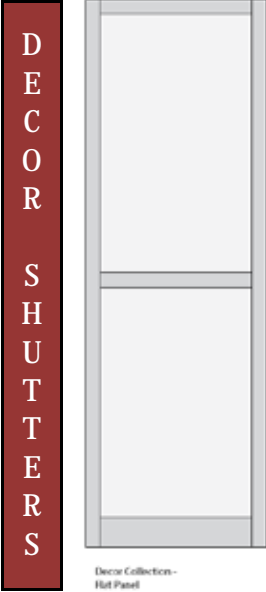

HEIGHT	WIDTH										
	12	14	16	18	20	22	24	26	28	30	32
24	\$106.73	\$124.52	\$142.31	\$160.09	\$177.89	\$195.67	\$213.46	\$231.25	\$249.04	\$266.83	\$284.62
30	\$133.42	\$155.65	\$177.89	\$200.12	\$222.36	\$244.60	\$266.83	\$289.06	\$311.29	\$333.53	\$355.77
36	\$160.09	\$186.78	\$213.46	\$240.14	\$266.83	\$293.51	\$320.20	\$346.87	\$373.56	\$400.24	\$426.93
42	\$186.78	\$217.91	\$249.04	\$280.17	\$311.29	\$342.43	\$373.56	\$404.69	\$435.82	\$466.95	\$498.07
48	\$213.46	\$249.04	\$284.62	\$320.20	\$355.77	\$391.35	\$426.93	\$462.50	\$498.07	\$533.65	\$569.23
54	\$240.14	\$280.17	\$320.20	\$360.22	\$400.24	\$440.27	\$480.29	\$520.31	\$560.34	\$600.36	\$640.38
60	\$266.83	\$311.29	\$355.77	\$400.24	\$444.71	\$489.18	\$533.65	\$578.13	\$622.60	\$667.07	\$711.54
66	\$293.51	\$342.43	\$391.35	\$440.27	\$489.18	\$538.11	\$587.02	\$635.94	\$684.85	\$733.78	\$782.69
72	\$320.20	\$373.56	\$426.93	\$480.29	\$533.65	\$587.02	\$640.38	\$693.75	\$747.12	\$800.49	\$853.85
78	\$346.87	\$404.69	\$462.50	\$520.31	\$578.13	\$635.94	\$693.75	\$751.56	\$809.38	\$867.19	\$925.00
84	\$373.56	\$435.82	\$498.07	\$560.34	\$622.60	\$684.85	\$747.12	\$809.38	\$871.64	\$933.89	\$996.16
90	\$400.24	\$466.95	\$533.65	\$600.36	\$667.07	\$733.78	\$800.49	\$867.19	\$933.89	\$1,000.60	\$1,067.31
96	\$426.93	\$498.07	\$569.23	\$640.38	\$711.54	\$782.69	\$853.85	\$925.00	\$996.16	\$1,067.31	\$1,138.47
102	\$453.60	\$529.21	\$604.81	\$680.41	\$756.01	\$831.61	\$907.21	\$982.82	\$1,058.42	\$1,134.02	\$1,209.62
108	\$480.29	\$560.34	\$640.38	\$720.43	\$800.49	\$880.53	\$960.58	\$1,040.63	\$1,120.67	\$1,200.72	\$1,280.78
114	\$506.98	\$591.47	\$675.96	\$760.46	\$844.96	\$929.45	\$1,013.94	\$1,098.44	\$1,182.94	\$1,267.43	\$1,351.92
120	\$533.65	\$622.60	\$711.54	\$800.49	\$889.42	\$978.36	\$1,067.31	\$1,156.25	\$1,245.20	\$1,334.14	\$1,423.08

**PRICES SUBJECT TO CHANGE WITHOUT NOTICE

SHUTTER OPTIONS		SELECT	SELECTED OPTIONS
FRAMES	SINGLE PANEL (1) - 5% Upcharge	<input type="checkbox"/>	
	TRIPLE PANEL(3) - 10% Upcharge	<input type="checkbox"/>	
	CUSTOM RAIL (9) - 15% Upcharge	<input type="checkbox"/>	
	CUSTOM SHUTTER DETAIL - 25% Upcharge	<input type="checkbox"/>	
ARCHED TOP (A) - 25% Upcharge		<input type="checkbox"/>	
PRICING INSTRUCTIONS			\$ -
ENTER PRICE INTO BLUE CELL			
HANGING OPTIONS:	FLUSH MOUNT (WOOD/SIDING) INCLUDED	<input type="checkbox"/>	
	FACE MOUNT (CONCRETE/BRICK)	<input type="checkbox"/>	
	HINGES (SEE HARDWARE PAGE)	<input type="checkbox"/>	
HARDWARE PAGE LINK			
TOTAL		\$	-

*Sold in Pairs
 **Prices reflect double panel shutters with even sized panels.
 *Prices subject to change without notice

SXRF1-1448 - Shutter,PVC- Decor Recessed Single Panel, 14"W x 48"H

DECOR COLLECTION SHUTTERS - 2018

BOARD & BATTEN SX(R)B1

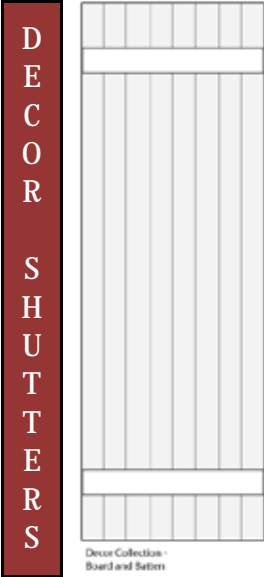

H E I G H T	W I D T H										
	12	14	16	18	20	22	24	26	28	30	32
24	\$109.24	\$127.45	\$145.65	\$163.86	\$182.06	\$200.27	\$218.47	\$236.69	\$254.89	\$273.10	\$291.30
30	\$136.54	\$159.31	\$182.06	\$204.82	\$227.58	\$250.33	\$273.10	\$295.85	\$318.61	\$341.37	\$364.12
36	\$163.86	\$191.17	\$218.47	\$245.78	\$273.10	\$300.40	\$327.71	\$355.02	\$382.34	\$409.64	\$436.95
42	\$191.17	\$223.03	\$254.89	\$286.75	\$318.61	\$350.48	\$382.34	\$414.19	\$446.05	\$477.91	\$509.77
48	\$218.47	\$254.89	\$291.30	\$327.71	\$364.12	\$400.54	\$436.95	\$473.36	\$509.77	\$546.19	\$582.60
54	\$245.78	\$286.75	\$327.71	\$368.68	\$409.64	\$450.61	\$491.57	\$532.54	\$573.50	\$614.47	\$655.42
60	\$273.10	\$318.61	\$364.12	\$409.64	\$455.16	\$500.68	\$546.19	\$591.70	\$637.22	\$682.74	\$728.25
66	\$300.40	\$350.48	\$400.54	\$450.61	\$500.68	\$550.74	\$600.81	\$650.88	\$700.94	\$751.01	\$801.08
72	\$327.71	\$382.34	\$436.95	\$491.57	\$546.19	\$600.81	\$655.42	\$710.05	\$764.67	\$819.28	\$873.91
78	\$355.02	\$414.19	\$473.36	\$532.54	\$591.70	\$650.88	\$710.05	\$769.21	\$828.39	\$887.56	\$946.73
84	\$382.34	\$446.05	\$509.77	\$573.50	\$637.22	\$700.94	\$764.67	\$828.39	\$892.11	\$955.83	\$1,019.56
90	\$409.64	\$477.91	\$546.19	\$614.47	\$682.74	\$751.01	\$819.28	\$887.56	\$955.83	\$1,024.11	\$1,092.38
96	\$436.95	\$509.77	\$582.60	\$655.42	\$728.25	\$801.08	\$873.91	\$946.73	\$1,019.56	\$1,092.38	\$1,165.21
102	\$464.27	\$541.64	\$619.01	\$696.39	\$773.77	\$851.14	\$928.52	\$1,005.90	\$1,083.28	\$1,160.65	\$1,238.03
108	\$491.57	\$573.50	\$655.42	\$737.35	\$819.28	\$901.21	\$983.14	\$1,065.07	\$1,147.00	\$1,228.93	\$1,310.86
114	\$518.88	\$605.36	\$691.84	\$778.32	\$864.80	\$951.28	\$1,037.76	\$1,124.24	\$1,210.72	\$1,297.20	\$1,383.68
120	\$546.19	\$637.22	\$728.25	\$819.28	\$910.32	\$1,001.35	\$1,092.38	\$1,183.41	\$1,274.44	\$1,365.47	\$1,456.51

****PRICES SUBJECT TO CHANGE WITHOUT NOTICE**

SHUTTER OPTIONS		SELECT	SELECTED OPTIONS
FRAMES	SINGLE PANEL - 5% Upcharge	<input type="checkbox"/>	
	TRIPLE PANEL - 10% Upcharge	<input type="checkbox"/>	
	CUSTOM RAIL - 15% Upcharge	<input type="checkbox"/>	
	CUSTOM SHUTTER DETAIL - 25% Upcharge	<input type="checkbox"/>	
	ARCHED TOP (A) - 25% Upcharge	<input type="checkbox"/>	
PRICING INSTRUCTIONS			
ENTER PRICE INTO BLUE CELL			
HANGING OPTIONS:	FLUSH MOUNT (WOOD/SIDING) INCLUDED	<input type="checkbox"/>	
	FACE MOUNT (CONCRETE/BRICK)	<input type="checkbox"/>	
	HINGES (SEE HARDWARE PAGE)	<input type="checkbox"/>	
HARDWARE PAGE LINK			
		TOTAL	\$ -

*Sold in Pairs
 **Prices reflect double panel shutters with even sized panels.
 *Prices subject to change without notice

SXRF1-1260 - Shutter,PVC- Décor Board & Batten, 12"W x 60"H

DECOR COLLECTION SHUTTERS - 2018

BOARD & "Z" BATTEN SX(R)B2

DECOR SHUTTERS

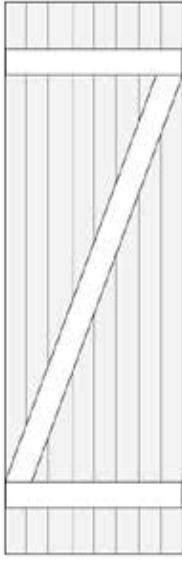

Decor Collection -
Board and Batten - Z Pattern

		WIDTH										
		12	14	16	18	20	22	24	26	28	30	32
HEIGHT	24	\$114.45	\$133.54	\$152.61	\$171.69	\$190.77	\$209.84	\$228.92	\$247.99	\$267.07	\$286.14	\$305.22
	30	\$143.08	\$166.92	\$190.77	\$214.61	\$238.46	\$262.30	\$286.14	\$309.99	\$333.83	\$357.68	\$381.53
	36	\$171.69	\$200.30	\$228.92	\$257.53	\$286.14	\$314.76	\$343.37	\$371.99	\$400.61	\$429.22	\$457.84
	42	\$200.30	\$233.68	\$267.07	\$300.46	\$333.83	\$367.22	\$400.61	\$433.99	\$467.37	\$500.76	\$534.14
	48	\$228.92	\$267.07	\$305.22	\$343.37	\$381.53	\$419.68	\$457.84	\$495.99	\$534.14	\$572.29	\$610.45
	54	\$257.53	\$300.46	\$343.37	\$386.30	\$429.22	\$472.14	\$515.06	\$557.99	\$600.91	\$643.83	\$686.75
	60	\$286.14	\$333.83	\$381.53	\$429.22	\$476.91	\$524.60	\$572.29	\$619.99	\$667.68	\$715.37	\$763.06
	66	\$314.76	\$367.22	\$419.68	\$472.14	\$524.60	\$577.06	\$629.53	\$681.98	\$734.44	\$786.90	\$839.37
	72	\$343.37	\$400.61	\$457.84	\$515.06	\$572.29	\$629.53	\$686.75	\$743.98	\$801.21	\$858.44	\$915.67
	78	\$371.99	\$433.99	\$495.99	\$557.99	\$619.99	\$681.98	\$743.98	\$805.98	\$867.98	\$929.97	\$991.97
	84	\$400.61	\$467.37	\$534.14	\$600.91	\$667.68	\$734.44	\$801.21	\$867.98	\$934.75	\$1,001.51	\$1,068.28
	90	\$429.22	\$500.76	\$572.29	\$643.83	\$715.37	\$786.90	\$858.44	\$929.97	\$1,001.51	\$1,073.05	\$1,144.59
	96	\$457.84	\$534.14	\$610.45	\$686.75	\$763.06	\$839.37	\$915.67	\$991.97	\$1,068.28	\$1,144.59	\$1,220.89
	102	\$486.45	\$567.52	\$648.60	\$729.68	\$810.74	\$891.82	\$972.90	\$1,053.97	\$1,135.05	\$1,216.13	\$1,297.19
108	\$515.06	\$600.91	\$686.75	\$772.59	\$858.44	\$944.28	\$1,030.12	\$1,115.97	\$1,201.81	\$1,287.66	\$1,373.51	
114	\$543.68	\$634.29	\$724.90	\$815.52	\$906.13	\$996.75	\$1,087.36	\$1,177.97	\$1,268.58	\$1,359.19	\$1,449.81	
120	\$572.29	\$667.68	\$763.06	\$858.44	\$953.82	\$1,049.20	\$1,144.59	\$1,239.97	\$1,335.35	\$1,430.73	\$1,526.11	

****PRICES SUBJECT TO CHANGE WITHOUT NOTICE**

SHUTTER OPTIONS		SELECT	SELECTED OPTIONS
FRAMES	SINGLE PANEL - 5% Upcharge	<input type="checkbox"/>	
	TRIPLE PANEL - 10% Upcharge	<input type="checkbox"/>	
	CUSTOM RAIL - 15% Upcharge	<input type="checkbox"/>	
	CUSTOM SHUTTER DETAIL - 25% Upcharge	<input type="checkbox"/>	
	ARCHED TOP (A) - 25% Upcharge	<input type="checkbox"/>	
PRICING INSTRUCTIONS			\$ -
ENTER PRICE INTO BLUE CELL			
HANGING OPTIONS:	FLUSH MOUNT (WOOD/SIDING) INCLUDED	<input type="checkbox"/>	
	FACE MOUNT (CONCRETE/BRICK)	<input type="checkbox"/>	
	HINGES (SEE HARDWARE PAGE)	<input type="checkbox"/>	
HARDWARE PAGE LINK			
TOTAL			\$ -

*Sold in Pairs

**Prices reflect double panel shutters with even sized panels.

*Prices subject to change without notice

SXRF2-1260 - Shutter.PVC- Decor Board & "Z" Batten, 12"W x 60"H



DISTINCTIVE COLLECTION SHUTTERS - 2018

RAISED PANEL SR(R)R(2)

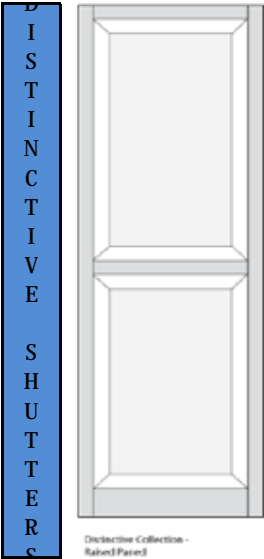

HEIGHT	WIDTH										
	12	14	16	18	20	22	24	26	28	30	32
24	\$ 112.81	\$ 131.60	\$ 150.41	\$ 169.20	\$ 188.00	\$ 206.81	\$ 225.60	\$ 244.41	\$ 263.20	\$ 282.01	\$ 300.81
30	\$ 141.00	\$ 164.50	\$ 188.00	\$ 211.51	\$ 235.00	\$ 258.50	\$ 282.01	\$ 305.51	\$ 329.00	\$ 352.51	\$ 376.01
36	\$ 169.20	\$ 197.40	\$ 225.60	\$ 253.81	\$ 282.01	\$ 310.21	\$ 338.41	\$ 366.61	\$ 394.81	\$ 423.01	\$ 451.21
42	\$ 197.40	\$ 230.30	\$ 263.20	\$ 296.10	\$ 329.00	\$ 361.91	\$ 394.81	\$ 427.71	\$ 460.61	\$ 493.52	\$ 526.42
48	\$ 225.60	\$ 263.20	\$ 300.81	\$ 338.41	\$ 376.01	\$ 413.61	\$ 451.21	\$ 488.82	\$ 526.42	\$ 564.01	\$ 601.61
54	\$ 253.81	\$ 296.10	\$ 338.41	\$ 380.71	\$ 423.01	\$ 465.31	\$ 507.61	\$ 549.91	\$ 592.22	\$ 634.51	\$ 676.82
60	\$ 282.01	\$ 329.00	\$ 376.01	\$ 423.01	\$ 470.01	\$ 517.01	\$ 564.01	\$ 611.01	\$ 658.02	\$ 705.01	\$ 752.02
66	\$ 310.21	\$ 361.91	\$ 413.61	\$ 465.31	\$ 517.01	\$ 568.71	\$ 620.42	\$ 672.11	\$ 723.82	\$ 775.52	\$ 827.22
72	\$ 338.41	\$ 394.81	\$ 451.21	\$ 507.61	\$ 564.01	\$ 620.42	\$ 676.82	\$ 733.22	\$ 789.62	\$ 846.02	\$ 902.43
78	\$ 366.61	\$ 427.71	\$ 488.82	\$ 549.91	\$ 611.01	\$ 672.11	\$ 733.22	\$ 794.32	\$ 855.42	\$ 916.52	\$ 977.62
84	\$ 394.81	\$ 460.61	\$ 526.42	\$ 592.22	\$ 658.02	\$ 723.82	\$ 789.62	\$ 855.42	\$ 921.22	\$ 987.02	\$ 1,052.82
90	\$ 423.01	\$ 493.52	\$ 564.01	\$ 634.51	\$ 705.01	\$ 775.52	\$ 846.02	\$ 916.52	\$ 987.02	\$ 1,057.53	\$ 1,128.03
96	\$ 451.21	\$ 526.42	\$ 601.61	\$ 676.82	\$ 752.02	\$ 827.22	\$ 902.43	\$ 977.62	\$ 1,052.82	\$ 1,128.03	\$ 1,203.23
102	\$ 479.41	\$ 559.32	\$ 639.21	\$ 719.12	\$ 799.02	\$ 878.92	\$ 958.82	\$ 1,038.73	\$ 1,118.63	\$ 1,198.53	\$ 1,278.44
108	\$ 507.61	\$ 592.22	\$ 676.82	\$ 761.42	\$ 846.02	\$ 930.63	\$ 1,015.22	\$ 1,099.83	\$ 1,184.43	\$ 1,269.03	\$ 1,353.63
114	\$ 535.81	\$ 625.12	\$ 714.42	\$ 803.72	\$ 893.02	\$ 982.32	\$ 1,071.63	\$ 1,160.93	\$ 1,250.23	\$ 1,339.54	\$ 1,428.83
120	\$ 564.01	\$ 658.02	\$ 752.02	\$ 846.02	\$ 940.02	\$ 1,034.03	\$ 1,128.03	\$ 1,222.03	\$ 1,316.03	\$ 1,410.04	\$ 1,504.04

****PRICES SUBJECT TO CHANGE WITHOUT NOTICE**

SHUTTER OPTIONS		SELECT	SELECTED OPTIONS
FRAMES	SINGLE PANEL (1)- 5% Upcharge	<input type="checkbox"/>	
	TRIPLE PANEL (3) - 10% Upcharge	<input type="checkbox"/>	
	CUSTOM RAIL (9) - 15% Upcharge	<input type="checkbox"/>	
	CUSTOM SHUTTER DETAIL - 25% Upcharge	<input type="checkbox"/>	
	ARCHED TOP (A)- 25% Upcharge	<input type="checkbox"/>	
PRICING INSTRUCTIONS			\$ -
ENTER PRICE INTO BLUE CELL			
HANGING OPTIONS:	FLUSH MOUNT (WOOD/SIDING) INCLUDED	<input type="checkbox"/>	
	FACE MOUNT (CONCRETE/BRICK)	<input type="checkbox"/>	
	HINGES (SEE HARDWARE PAGE)	<input type="checkbox"/>	
HARDWARE PAGE LINK			
TOTAL			\$ -

*Sold in Pairs
 **Prices reflect double panel shutters with even sized panels.
 *Prices subject to change without notice

[SXRRR2-1666](#) - Shutter,PVC- Distinctive, Raised Double Panel, 16"W x 66"H



DISTINCTIVE COLLECTION SHUTTERS - 2018



RECESSED PANEL SR(R)F(2)

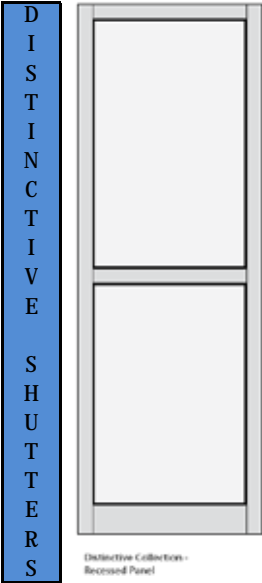

HEIGHT	WIDTH										
	12	14	16	18	20	22	24	26	28	30	32
24	\$ 103.91	\$ 121.22	\$ 138.55	\$ 155.86	\$ 173.18	\$ 190.49	\$ 207.81	\$ 225.14	\$ 242.45	\$ 259.77	\$ 277.08
30	\$ 129.88	\$ 151.53	\$ 173.18	\$ 194.83	\$ 216.47	\$ 238.12	\$ 259.77	\$ 281.42	\$ 303.06	\$ 324.71	\$ 346.36
36	\$ 155.86	\$ 181.84	\$ 207.81	\$ 233.79	\$ 259.77	\$ 285.74	\$ 311.73	\$ 337.70	\$ 363.67	\$ 389.65	\$ 415.63
42	\$ 181.84	\$ 212.14	\$ 242.45	\$ 272.76	\$ 303.06	\$ 333.37	\$ 363.67	\$ 393.98	\$ 424.29	\$ 454.60	\$ 484.90
48	\$ 207.81	\$ 242.45	\$ 277.08	\$ 311.73	\$ 346.36	\$ 380.99	\$ 415.63	\$ 450.26	\$ 484.90	\$ 519.54	\$ 554.17
54	\$ 233.79	\$ 272.76	\$ 311.73	\$ 350.69	\$ 389.65	\$ 428.61	\$ 467.58	\$ 506.54	\$ 545.51	\$ 584.48	\$ 623.44
60	\$ 259.77	\$ 303.06	\$ 346.36	\$ 389.65	\$ 432.95	\$ 476.24	\$ 519.54	\$ 562.83	\$ 606.13	\$ 649.42	\$ 692.71
66	\$ 285.74	\$ 333.37	\$ 380.99	\$ 428.61	\$ 476.24	\$ 523.86	\$ 571.49	\$ 619.12	\$ 666.74	\$ 714.36	\$ 761.99
72	\$ 311.73	\$ 363.67	\$ 415.63	\$ 467.58	\$ 519.54	\$ 571.49	\$ 623.44	\$ 675.40	\$ 727.35	\$ 779.30	\$ 831.25
78	\$ 337.70	\$ 393.98	\$ 450.26	\$ 506.54	\$ 562.83	\$ 619.12	\$ 675.40	\$ 731.68	\$ 787.96	\$ 844.24	\$ 900.53
84	\$ 363.67	\$ 424.29	\$ 484.90	\$ 545.51	\$ 606.13	\$ 666.74	\$ 727.35	\$ 787.96	\$ 848.58	\$ 909.18	\$ 969.80
90	\$ 389.65	\$ 454.60	\$ 519.54	\$ 584.48	\$ 649.42	\$ 714.36	\$ 779.30	\$ 844.24	\$ 909.18	\$ 974.13	\$ 1,039.07
96	\$ 415.63	\$ 484.90	\$ 554.17	\$ 623.44	\$ 692.71	\$ 761.99	\$ 831.25	\$ 900.53	\$ 969.80	\$ 1,039.07	\$ 1,108.35
102	\$ 441.60	\$ 515.20	\$ 588.81	\$ 662.41	\$ 736.00	\$ 809.61	\$ 883.21	\$ 956.81	\$ 1,030.41	\$ 1,104.01	\$ 1,177.61
108	\$ 467.58	\$ 545.51	\$ 623.44	\$ 701.37	\$ 779.30	\$ 857.24	\$ 935.17	\$ 1,013.10	\$ 1,091.02	\$ 1,168.95	\$ 1,246.88
114	\$ 493.56	\$ 575.82	\$ 658.08	\$ 740.34	\$ 822.59	\$ 904.86	\$ 987.11	\$ 1,069.38	\$ 1,151.64	\$ 1,233.90	\$ 1,316.16
120	\$ 519.54	\$ 606.13	\$ 692.71	\$ 779.30	\$ 865.89	\$ 952.48	\$ 1,039.07	\$ 1,125.66	\$ 1,212.25	\$ 1,298.84	\$ 1,385.43

**PRICES SUBJECT TO CHANGE WITHOUT NOTICE

SHUTTER OPTIONS		SELECT	SELECTED OPTIONS
FRAMES	SINGLE PANEL (1)- 5% Upcharge	<input type="checkbox"/>	
	TRIPLE PANEL(3) - 10% Upcharge	<input type="checkbox"/>	
	CUSTOM RAIL (9) - 15% Upcharge	<input type="checkbox"/>	
	CUSTOM SHUTTER DETAIL - 25% Upcharge	<input type="checkbox"/>	
	ARCHED TOP (A)- 25% Upcharge	<input type="checkbox"/>	
PRICING INSTRUCTIONS			\$ -
ENTER PRICE INTO BLUE CELL			
HANGING OPTIONS:	FLUSH MOUNT (WOOD/SIDING) INCLUDED	<input type="checkbox"/>	
	FACE MOUNT (CONCRETE/BRICK)	<input type="checkbox"/>	
	HINGES (SEE HARDWARE PAGE)	<input type="checkbox"/>	
HARDWARE PAGE LINK			
		TOTAL	\$ -

*Sold in Pairs
 **Prices reflect double panel shutters with even sized panels.
 *Prices subject to change without notice

SXRRF3-1896 - Shutter,PVC- Distictive, Recessed Double Panel, 18"W x 96"H



DISTINCTIVE COLLECTION SHUTTERS - 2018



CLOSED LOUVRE SR(R)L(2)



HEIGHT	WIDTH										
	12	14	16	18	20	22	24	26	28	30	32
24	\$ 127.40	\$ 148.63	\$ 169.87	\$ 191.09	\$ 212.32	\$ 233.56	\$ 254.79	\$ 276.03	\$ 297.25	\$ 318.49	\$ 339.72
30	\$ 159.24	\$ 185.79	\$ 212.32	\$ 238.87	\$ 265.40	\$ 291.95	\$ 318.49	\$ 345.03	\$ 371.57	\$ 398.11	\$ 424.65
36	\$ 191.09	\$ 222.95	\$ 254.79	\$ 286.64	\$ 318.49	\$ 350.34	\$ 382.19	\$ 414.04	\$ 445.88	\$ 477.73	\$ 509.59
42	\$ 222.95	\$ 260.10	\$ 297.25	\$ 334.41	\$ 371.57	\$ 408.72	\$ 445.88	\$ 483.04	\$ 520.20	\$ 557.36	\$ 594.51
48	\$ 254.79	\$ 297.25	\$ 339.72	\$ 382.19	\$ 424.65	\$ 467.12	\$ 509.59	\$ 552.04	\$ 594.51	\$ 636.98	\$ 679.44
54	\$ 286.64	\$ 334.41	\$ 382.19	\$ 429.96	\$ 477.73	\$ 525.51	\$ 573.28	\$ 621.05	\$ 668.83	\$ 716.60	\$ 764.38
60	\$ 318.49	\$ 371.57	\$ 424.65	\$ 477.73	\$ 530.81	\$ 583.90	\$ 636.98	\$ 690.06	\$ 743.14	\$ 796.22	\$ 849.31
66	\$ 350.34	\$ 408.72	\$ 467.12	\$ 525.51	\$ 583.90	\$ 642.28	\$ 700.68	\$ 759.07	\$ 817.46	\$ 875.84	\$ 934.23
72	\$ 382.19	\$ 445.88	\$ 509.59	\$ 573.28	\$ 636.98	\$ 700.68	\$ 764.38	\$ 828.07	\$ 891.76	\$ 955.47	\$ 1,019.16
78	\$ 414.04	\$ 483.04	\$ 552.04	\$ 621.05	\$ 690.06	\$ 759.07	\$ 828.07	\$ 897.08	\$ 966.08	\$ 1,035.08	\$ 1,104.10
84	\$ 445.88	\$ 520.20	\$ 594.51	\$ 668.83	\$ 743.14	\$ 817.46	\$ 891.76	\$ 966.08	\$ 1,040.40	\$ 1,114.71	\$ 1,189.03
90	\$ 477.73	\$ 557.36	\$ 636.98	\$ 716.60	\$ 796.22	\$ 875.84	\$ 955.47	\$ 1,035.08	\$ 1,114.71	\$ 1,194.34	\$ 1,273.95
96	\$ 509.59	\$ 594.51	\$ 679.44	\$ 764.38	\$ 849.31	\$ 934.23	\$ 1,019.16	\$ 1,104.10	\$ 1,189.03	\$ 1,273.95	\$ 1,358.88
102	\$ 541.43	\$ 631.67	\$ 721.91	\$ 812.15	\$ 902.39	\$ 992.63	\$ 1,082.86	\$ 1,173.10	\$ 1,263.34	\$ 1,353.58	\$ 1,443.82
108	\$ 573.28	\$ 668.83	\$ 764.38	\$ 859.92	\$ 955.47	\$ 1,051.02	\$ 1,146.56	\$ 1,242.11	\$ 1,337.66	\$ 1,433.20	\$ 1,528.75
114	\$ 605.13	\$ 705.99	\$ 806.84	\$ 907.70	\$ 1,008.55	\$ 1,109.40	\$ 1,210.26	\$ 1,311.11	\$ 1,411.97	\$ 1,512.82	\$ 1,613.67
120	\$ 636.98	\$ 743.14	\$ 849.31	\$ 955.47	\$ 1,061.63	\$ 1,167.79	\$ 1,273.95	\$ 1,380.12	\$ 1,486.28	\$ 1,592.44	\$ 1,698.61

**PRICES SUBJECT TO CHANGE WITHOUT NOTICE

SHUTTER OPTIONS		SELECT	SELECTED OPTIONS
FRAMES	SINGLE PANEL (1) - 5% Upcharge	<input type="checkbox"/>	
	TRIPLE PANEL (3) - 10% Upcharge	<input type="checkbox"/>	
	CUSTOM RAIL (9) - 15% Upcharge	<input type="checkbox"/>	
	CUSTOM SHUTTER DETAIL - 25% Upcharge	<input type="checkbox"/>	
	ARCHED TOP (A) - 25% Upcharge	<input type="checkbox"/>	
PRICING INSTRUCTIONS			
ENTER PRICE INTO BLUE CELL			
HANGING OPTIONS:	FLUSH MOUNT (WOOD/SIDING) INCLUDED	<input type="checkbox"/>	
	FACE MOUNT (CONCRETE/BRICK)	<input type="checkbox"/>	
	HINGES (SEE HARDWARE PAGE)	<input type="checkbox"/>	
HARDWARE PAGE LINK			
		TOTAL	\$ -

*Sold in Pairs
 **Prices reflect double panel shutters with even sized panels.
 *Prices subject to change without notice

SXRRL1-1454 - Shutter,PVC- Distictive, Closed Louvre Single Panel, 14"W x 54"H

PRESTIGE FLEX SHUTTERS - 2018

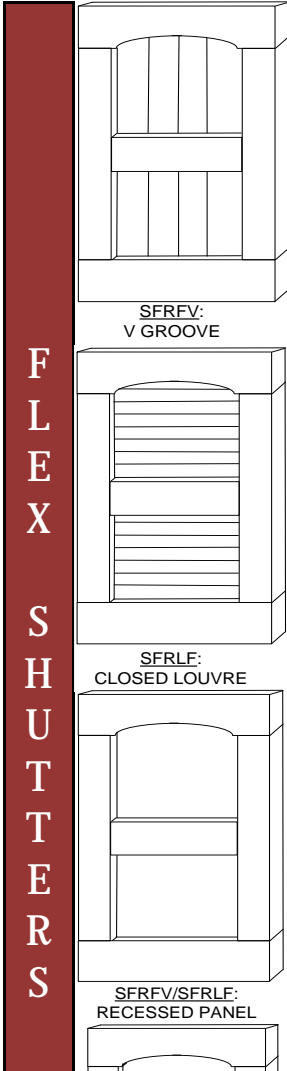

FLEX SHUTTERS

PRODUCT CODE
SFRFV-1648
SFRFV-1660
SFRFV-1672
SFRLF-1648
SFRLF-1660
SFRLF-1672

DESCRIPTION
16" x 48" Reversible Shutter (V Groove/Recessed)
16" x 60" Reversible Shutter (V Groove/Recessed)
16" x 72" Reversible Shutter (V Groove/Recessed)
16" x 48" Reversible Shutter (Closed Louvre/Recessed)
16" x 60" Reversible Shutter (Closed Louvre/Recessed)
16" x 72" Reversible Shutter (Closed Louvre/Recessed)

PAIR COST
\$ 219.20
\$ 245.17
\$ 251.01
\$ 269.31
\$ 295.28
\$ 301.11

TOP FRAME ACCESSORIES

SFACC-RT
SFACC-HT
SFACC-TT
SFACC-LA
SFACC-LR

Round Top (16" Full Round)
Half Round Top (16" 1/4 Round)
Tapered Top (16" Taper)
Low Arch Top (8" 1/4 Round)
Round Top (Low) (8" Full Round)

\$ 49.67
\$ 49.67
\$ 49.67
\$ 27.75
\$ 27.75

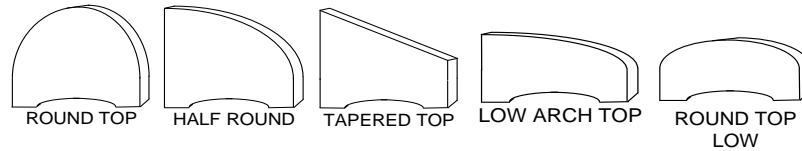

*SHUTTERS CAN BE CUT TO SUIT HEIGHT
 *SELECT "V" GROOVE OR RECESSED PANEL OR CLOSED LOUVRE OR MIX MATCH (I.E. RECESSED/"V" GROOVE)

**PRICES SUBJECT TO CHANGE WITHOUT NOTICE

PRESTIGE LOUVRES - 2018

P
R
E
S
T
I
G
E

L
O
U
V
R
E
S

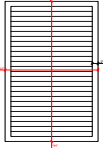
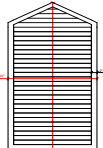
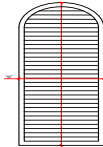
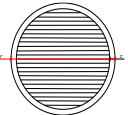
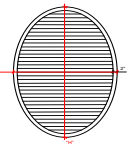
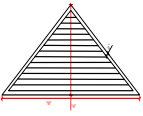
	PRODUCT CODE	DESCRIPTION	WIDTH (IN)	HEIGHT (IN)	STANDARD PACKAGE
 <p>RECTANGLE</p>	LPC3G-12(24)	Prestige PVC Louvre, 12" x 24" Rectangle, Closed Louvre /w Brick Mould Surround & Sill	12	24	\$ 37.98
	LPC3G-16(36)	Prestige PVC Louvre, 16" x 36" Rectangle, Closed Louvre /w Brick Mould Surround & Sill	16	36	\$ 55.20
	LPC3G-20(48)	Prestige PVC Louvre, 20" x 48" Rectangle, Closed Louvre /w Brick Mould Surround & Sill	20	48	\$ 85.08
 <p>PEAK TOP</p>	LPC3K-12(48)	Prestige PVC Louvre, 12" x 24" Peak Top Rectangle, Closed Louvre /w Brick Mould Surround & Sill	12	48	\$ 41.06
	LPC3K-16(48)	Prestige PVC Louvre, 16" x 36" Peak Top Rectangle, Closed Louvre /w Brick Mould Surround & Sill	16	48	\$ 59.68
	LPC3K-20(48)	Prestige PVC Louvre, 20" x 48" Peak Top Rectangle, Closed Louvre /w Brick Mould Surround & Sill	20	48	\$ 91.98
 <p>ROUND TOP</p>	LPC3H-12(48)	Prestige PVC Louvre, 12" x 24" Round Top Rectangle, Closed Louvre /w Brick Mould Surround & Sill	12	48	\$ 43.12
	LPC3H-16(48)	Prestige PVC Louvre, 16" x 36" Round Top Rectangle, Closed Louvre /w Brick Mould Surround & Sill	16	48	\$ 62.66
	LPC3H-20(48)	Prestige PVC Louvre, 20" x 48" Round Top Rectangle, Closed Louvre /w Brick Mould Surround & Sill	20	48	\$ 96.59
 <p>ROUND</p>	LPC1A-16	Prestige PVC Louvre, 16"ID Round, Closed Louvre /w 4/4" x 3 1/2" Frame	16	16	\$ 47.26
	LPC1A-20	Prestige PVC Louvre, 20"ID Round, Closed Louvre /w 4/4" x 3 1/2" Frame	20	20	\$ 60.95
	LPC1A-24	Prestige PVC Louvre, 24"ID Round, Closed Louvre /w 4/4" x 3 1/2" Frame	24	24	\$ 67.16
 <p>OVAL</p>	LPC1C-16(36)	Prestige PVC Louvre, 16" x 36"ID Oval, Closed Louvre /w 4/4" x 3 1/2" Frame	16	36	\$ 92.50
	LPC1C-18(42)	Prestige PVC Louvre, 18" x 42"ID Oval, Closed Louvre /w 4/4" x 3 1/2" Frame	18	42	\$ 122.13
	LPC1C-22(48)	Prestige PVC Louvre, 22" x 48"ID Oval, Closed Louvre /w 4/4" x 3 1/2" Frame	22	48	\$ 142.58
 <p>TRIANGLE</p>	LPC3F-12(48)	Prestige PVC Louvre, 12" x 24" Triangle, Closed Louvre /w Brick Mould Surround & Sill	12	48	\$ 53.38
	LPC3F-16(48)	Prestige PVC Louvre, 16" x 36" Triangle Rectangle, Closed Louvre /w Brick Mould Surround & Sill	16	48	\$ 77.58
	LPC3F-20(48)	Prestige PVC Louvre, 20" x 48" Triangle Rectangle, Closed Louvre /w Brick Mould Surround & Sill	20	48	\$ 119.57

**PRICES SUBJECT TO CHANGE WITHOUT NOTICE

PRESTIGE LOUVRES - 2018

PRESTIGE LOUVRES

WIDTH	HEIGHT	PRODUCT CODE	PRICE
12"	12"	LPC(Y)(X)-1212	\$ 16.79
	24"	LPC(Y)(X)-1224	\$ 18.72
	30"	LPC(Y)(X)-1230	\$ 23.40
	36"	LPC(Y)(X)-1236	\$ 28.08
	42"	LPC(Y)(X)-1242	\$ 32.76
	48"	LPC(Y)(X)-1248	\$ 36.05
	72"	LPC(Y)(X)-1272	\$ 52.20
	96"	LPC(Y)(X)-1296	\$ 64.61
	120"	LPC(Y)(X)-12120	\$ 88.25

WIDTH	HEIGHT	PRODUCT CODE	PRICE
20"	12"	LPC(Y)(X)-2012	\$ 27.98
	24"	LPC(Y)(X)-2024	\$ 30.48
	30"	LPC(Y)(X)-2030	\$ 34.35
	36"	LPC(Y)(X)-2036	\$ 38.24
	42"	LPC(Y)(X)-2042	\$ 42.11
	48"	LPC(Y)(X)-2048	\$ 46.00
	72"	LPC(Y)(X)-2072	\$ 72.73
	96"	LPC(Y)(X)-2096	\$ 88.25
	120"	LPC(Y)(X)-20120	\$ 111.66

WIDTH	HEIGHT	PRODUCT CODE	PRICE
30"	12"	LPC(Y)(X)-3012	\$ 41.98
	24"	LPC(Y)(X)-3024	\$ 49.46
	30"	LPC(Y)(X)-3030	\$ 55.27
	36"	LPC(Y)(X)-3036	\$ 61.09
	42"	LPC(Y)(X)-3042	\$ 66.91
	48"	LPC(Y)(X)-3048	\$ 72.73
	72"	LPC(Y)(X)-3072	\$ 103.90
	96"	LPC(Y)(X)-3096	\$ 127.16
	120"	LPC(Y)(X)-30120	\$ 183.69

WIDTH	HEIGHT	PRODUCT CODE	PRICE
42"	12"	LPC(Y)(X)-4212	\$ 58.76
	24"	LPC(Y)(X)-4224	\$ 65.03
	30"	LPC(Y)(X)-4230	\$ 75.09
	36"	LPC(Y)(X)-4236	\$ 76.10
	42"	LPC(Y)(X)-4242	\$ 91.37
	48"	LPC(Y)(X)-4248	\$ 99.53
	72"	LPC(Y)(X)-4272	\$ 143.44
	96"	LPC(Y)(X)-4296	\$ 174.56
	120"	LPC(Y)(X)-42120	\$ 229.02

WIDTH	HEIGHT	PRODUCT CODE	PRICE
48"	96"	LPCSHT-4896	\$ 183.03
96"	48"	LPCSHT-9648	\$ 183.03

WIDTH	HEIGHT	PRODUCT CODE	PRICE
16"	12"	LPC(Y)(X)-1612	\$ 22.39
	24"	LPC(Y)(X)-1624	\$ 23.63
	30"	LPC(Y)(X)-1630	\$ 26.73
	36"	LPC(Y)(X)-1636	\$ 29.84
	42"	LPC(Y)(X)-1642	\$ 32.94
	48"	LPC(Y)(X)-1648	\$ 37.44
	72"	LPC(Y)(X)-1672	\$ 56.16
	96"	LPC(Y)(X)-1696	\$ 74.88
	120"	LPC(Y)(X)-16120	\$ 93.60

WIDTH	HEIGHT	PRODUCT CODE	PRICE
24"	12"	LPC(Y)(X)-2412	\$ 18.72
	24"	LPC(Y)(X)-2424	\$ 33.58
	30"	LPC(Y)(X)-2430	\$ 38.24
	36"	LPC(Y)(X)-2436	\$ 42.89
	42"	LPC(Y)(X)-2442	\$ 47.54
	48"	LPC(Y)(X)-2448	\$ 52.20
	72"	LPC(Y)(X)-2472	\$ 82.04
	96"	LPC(Y)(X)-2496	\$ 100.66
	120"	LPC(Y)(X)-24120	\$ 127.16

WIDTH	HEIGHT	PRODUCT CODE	PRICE
36"	12"	LPC(Y)(X)-3612	\$ 50.37
	24"	LPC(Y)(X)-3624	\$ 55.74
	30"	LPC(Y)(X)-3630	\$ 64.37
	36"	LPC(Y)(X)-3636	\$ 65.23
	42"	LPC(Y)(X)-3642	\$ 78.32
	48"	LPC(Y)(X)-3648	\$ 85.31
	72"	LPC(Y)(X)-3672	\$ 137.46
	96"	LPC(Y)(X)-3696	\$ 165.66
	120"	LPC(Y)(X)-36120	\$ 209.79

WIDTH	HEIGHT	PRODUCT CODE	PRICE
48"	12"	LPC(Y)(X)-4812	\$ 61.16
	24"	LPC(Y)(X)-4824	\$ 63.41
	30"	LPC(Y)(X)-4830	\$ 72.73
	36"	LPC(Y)(X)-4836	\$ 82.04
	42"	LPC(Y)(X)-4842	\$ 91.34
	48"	LPC(Y)(X)-4848	\$ 100.66
	72"	LPC(Y)(X)-4872	\$ 145.79
	96"	LPC(Y)(X)-4896	\$ 183.03
	120"	LPC(Y)(X)-48120	\$ 253.51

LOUVRE OPTIONS		SELECT	SELECTED OPTIONS
FRAMES	4/4" X 2" FRAME (3) - 50% Upcharge	<input type="checkbox"/>	
	BRICK MOULD (1) - 80% Upcharge	<input type="checkbox"/>	
	4/4" X 3 1/2" FRAME (5) - 100% Upcharge	<input type="checkbox"/>	
	4/4" X 5 1/2" FRAME (7) - 110% Upcharge	<input type="checkbox"/>	
	SILL (S) - 5% Upcharge	<input type="checkbox"/>	
PEAK TOP LOUVRE (LPC(K)) - 15% Upcharge		<input type="checkbox"/>	
OCTAGON LOUVRE (LPC(L)) - 85% Upcharge		<input type="checkbox"/>	
TRIANGLE LOUVRE (LPC(F)) - 75% Upcharge		<input type="checkbox"/>	
1/2 TRIANGLE LOUVRE (LPC(N)-(L) or (R)) - 15% Upcharge		<input type="checkbox"/>	
ROUND LOUVRE (LPC(A)) - 75% Upcharge (Red #'s for Frameless Round Louvres)		<input type="checkbox"/>	
ARCH TOP LOUVRE (LPC(H)) - 25% Upcharge		<input type="checkbox"/>	
OVAL LOUVRE (LPC(C)) - 110% Upcharge		<input type="checkbox"/>	
PRICING INSTRUCTIONS			\$ -
PRICE	ENTER PRICE INTO BLUE CELL		

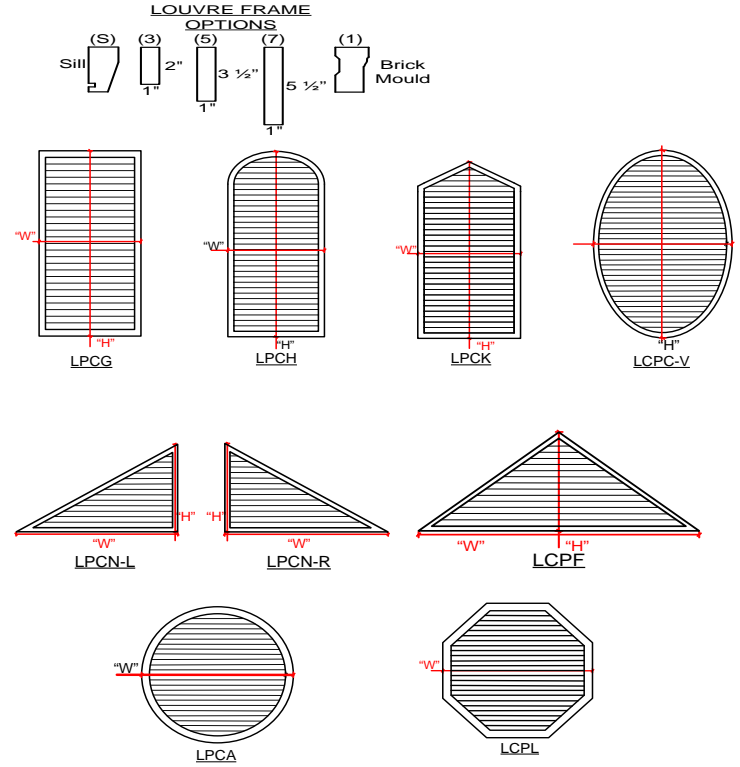

* ABOVE PRICES REFLECT FRAMELESS RECTANGLE LOUVRE

**PRICES SUBJECT TO CHANGE WITHOUT NOTICE



Assembly & Installation Instructions

Congratulations on your purchase of your new Prestige Gable™ Detail. These gables are designed to bring a classical architectural design to your home, and are engineered for easy installation. Before you begin your install, please take a few moments to unpack and review the contents of your package. Each Gable Detail will be installed behind the fascia board. You will need different fasteners depending on the application.

Note: The below installation instructions are suggested practices only. Fastener length may vary depending on product purchased. Ensure for 1" penetration into wood structure.

Materials Included:

- One (1) gable post with mounting block
- Two (2) gable stretchers
- Four (4), #8, 3" galvanized wood screws
- Three (3) screws per side of stretcher

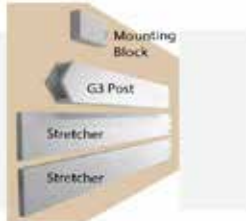

Prestige Gable Detail dimensions: 4" x 12" actual size, 4" x 10" actual is also available.

Gable Detail: Assembly



• On a clean flat surface, layout the gable detail parts.

• Using spacers to adjust the depth, place the two gable stretchers at the desired height from the bottom of the gable post or line up with pre marked holes.

It is recommended not to exceed 4" from the bottom of gable post.

• Using the #8 galvanized wood screws provided, toe screw the stretcher to the middle gable post. The holes are pre drilled for easy assembly.

• Fasten both stretchers to either side of the gable post.



Gable Detail: Installation Instructions

• Once the gable detail is assembled, remove the mounting block positioned in the gable post.



• Using the four (4) 3" #8 galvanized wood screws provided, fasten the mounting block to the top gable peak sub-fascia.

**** Best method is to screw two (2) from back of fascia and two (2) from the front. ****

• Once mounting block is secured, with stretchers attached, slide gable post over block and fasten to the mounting block using four (4) 2" #8 galvanized wood screws. (Fasteners not included)



• Once gable post has been fastened to the mounting block, level post before fastening stretchers to sub fascia.



• By screwing two (2) screws into both the front and back, you securely lock the gable into place both ways.



Congratulations, your Prestige Gable is now completely installed and ready to enjoy. While not required, your gable can be painted.





PRESTIGE 4" IT GABLES - 2018



	INVERTED "T" GABLES	PRODUCT CODE		DESCRIPTION	FORMAT	
		G1	G3		1" POST (G1)	2 1/2" POST (G3)
<p>G1 1" 3 1/2"</p>	<p>D1-4</p>	G11TB414-72	G31TB42.54-72	Gable Detail-4" - PVC, Inverted "T" @ 6' wide with ball (All Pitches) Gable Detail-4" - PVC, Inverted "T" @ 8' wide with ball (All Pitches) Gable Detail-4" - PVC, Inverted "T" @ 12' wide with ball (All Pitches) * Standard gable program designed to be cut to fit on-site if required	\$ 128.72	\$ 168.83
		G11TB414-96	G31TB42.54-96		\$ 159.34	\$ 222.27
		G11TB414-144	G31TB42.54-144		\$ 220.61	\$ 329.14
	<p>D2-4</p>	G11T414-72	G31T42.54-72	Gable Detail-4" - PVC, Inverted "T" @ 6' wide (All Pitches) Gable Detail-4" - PVC, Inverted "T", @ 8' wide (All Pitches) Gable Detail-4" - PVC, Inverted "T" @ 12' wide (All Pitches) * Standard gable program designed to be cut to fit on-site if required	\$ 92.45	\$ 132.56
		G11T414-96	G31T42.54-96		\$ 123.07	\$ 186.00
		G11T414-144	G31T42.54-144		\$ 184.34	\$ 292.87
	<p>D3-4</p>	G11TAB414-72	G31TAB42.54-72	Gable Detail-4" - PVC, Inverted "T", Arched @ 6' wide with ball (All Pitches) Gable Detail-4" - PVC, Inverted "T", Arched @ 8' wide with ball (All Pitches) Gable Detail-4" - PVC, Inverted "T", Arched, @ 12' wide with ball (All Pitches) * Standard gable program designed to be cut to fit on-site if required	\$ 164.44	\$ 243.01
		G11TAB414-96	G31TAB42.54-96		\$ 197.44	\$ 276.03
		G11TAB414-144	G31TAB42.54-144		\$ 263.47	\$ 342.04
	<p>D4-4</p>	G11TA4145-72	G31TA42.54-72	Gable Detail-4" - PVC, Inverted "T", Arched @ 6' wide (All Pitches) Gable Detail-4" - PVC, Inverted "T", Arched @ 8' wide (All Pitches) Gable Detail-4" - PVC, Inverted "T", Arched @ 12' wide (All Pitches) * Standard gable program designed to be cut to fit on-site if required	\$ 137.11	\$ 206.74
G11TA4148-96		G31TA42.54-96	\$ 167.52		\$ 239.76	
G11TA41411-144		G31TA42.54-144	\$ 226.36		\$ 305.77	
<p>G3 2 1/2" 3 1/2"</p> <p>D5-4</p>	G11TVB414-72	G31TVB42.54-72	Gable Detail-4" - PVC, Inverted "T" & "V" @ 6' wide with ball (All Pitches) Gable Detail-4" - PVC, Inverted "T" & "V" @ 8' wide with ball (All Pitches) Gable Detail-4" - PVC, Inverted "T" & "V" @ 12' wide with ball (All Pitches) * Standard gable program designed to be cut to fit on-site if required	\$ 168.13	\$ 271.37	
	G11TVB414-96	G31TVB42.54-96		\$ 187.34	\$ 290.57	
	G11TVB414-144	G31TVB42.54-144		\$ 225.74	\$ 328.98	
<p>D6-4</p>	G11TV414-72	G31TV42.54-72	Gable Detail-4" - PVC, Inverted "T" & "V" @ 6' wide (All Pitches) Gable Detail-4" - PVC, Inverted "T" & "V" @ 8' wide (All Pitches) Gable Detail-4" - PVC, Inverted "T" & "V" @ 12' wide (All Pitches) * Standard gable program designed to be cut to fit on-site if required	\$ 131.86	\$ 235.10	
	G11TV414-96	G31TV42.54-96		\$ 151.07	\$ 254.30	
	G11TV414-144	G31TV42.54-144		\$ 189.47	\$ 292.71	
<p>D13-4</p>	G11TVAB414-72	G31TVAB42.54-72	Gable Detail-4" - PVC, Inverted "T" & "V", Arched @ 6' wide with ball (All Pitches) Gable Detail-4" - PVC, Inverted "T" & "V", Arched @ 8' wide with ball (All Pitches) Gable Detail-4" - PVC, Inverted "T" & "V", Arched, @ 12' wide with ball (All Pitches) * Standard gable program designed to be cut to fit on-site if required	\$ 215.09	\$ 310.97	
	G11TVAB414-96	G31TVAB42.54-96		\$ 225.64	\$ 321.52	
	G11TVAB414-144	G31TVAB42.54-144		\$ 246.74	\$ 342.60	
<p>D14-4</p>	G11TVA414-72	G31TVA42.54-72	Gable Detail-4" - PVC, Inverted "T" & "V", Arched @ 6' wide (All Pitches) Gable Detail-4" - PVC, Inverted "T" & "V", Arched @ 8' wide (All Pitches) Gable Detail-4" - PVC, Inverted "T" & "V", Arched @ 12' wide (All Pitches) * Standard gable program designed to be cut to fit on-site if required	\$ 178.82	\$ 274.70	
	G11TVA414-96	G31TVA42.54-96		\$ 189.37	\$ 285.25	
	G11TVA414-144	G31TVA42.54-144		\$ 210.47	\$ 306.33	

**PRICES SUBJECT TO CHANGE WITHOUT NOTICE



PRESTIGE 6" IT GABLES - 2018



PRESTIGE GABLES



INVERTED "T" GABLES	PRODUCT CODE	
	G1	G3
D1-6 	G1ITB616-72 G1ITB616-96 G1ITB616-144	G3ITB62.56-72 G3ITB62.56-96 G3ITB62.56-144
D2-6 	G1IT616-72 G1IT616-96 G1IT616-144	G3IT62.56-72 G3IT62.56-96 G3IT62.56-144
D3-6 	G1ITAB616-72 G1ITAB616-96 G1ITAB616-144	G3ITAB62.56-72 G3ITAB62.56-96 G3ITAB62.56-144
D4-6 	G1ITA6165-72 G1ITA6168-96 G1ITA61611-144	G3ITA62.56-72 G3ITA62.56-96 G3ITA62.56-144
D5-6 	G1ITVB616-72 G1ITVB616-96 G1ITVB616-144	G3ITVB62.56-72 G3ITVB62.56-96 G3ITVB62.56-144
D6-6 	G1ITV616-72 G1ITV616-96 G1ITV616-144	G3ITV62.56-72 G3ITV62.56-96 G3ITV62.56-144
D13-6 	G1ITVAB616-72 G1ITVAB616-96 G1ITVAB616-144	G3ITVAB62.56-72 G3ITVAB62.56-96 G3ITVAB62.56-144
D14-6 	G1ITVA616-72 G1ITVA616-96 G1ITVA616-144	G3ITVA62.56-72 G3ITVA62.56-96 G3ITVA62.56-144

DESCRIPTION
Roof Pitch Must be Supplied for Manufacturing
Gable Detail-6" - PVC, Inverted "T" @ 6' wide with ball (All Pitches) Gable Detail-6" - PVC, Inverted "T" @ 8' wide with ball (All Pitches) Gable Detail-6" - PVC, Inverted "T" @ 12' wide with ball (All Pitches) * Standard gable program designed to be cut to fit on-site if required
Gable Detail-6" - PVC, Inverted "T" @ 6' wide (All Pitches) Gable Detail-6" - PVC, Inverted "T", @ 8' wide (All Pitches) Gable Detail-6" - PVC, Inverted "T" @ 12' wide (All Pitches) * Standard gable program designed to be cut to fit on-site if required
Gable Detail-6" - PVC, Inverted "T", Arched @ 6' wide with ball (All Pitches) Gable Detail-6" - PVC, Inverted "T", Arched @ 8' wide with ball (All Pitches) Gable Detail-6" - PVC, Inverted "T", Arched, @ 12' wide with ball (All Pitches) * Standard gable program designed to be cut to fit on-site if required
Gable Detail-6" - PVC, Inverted "T", Arched @ 6' wide (All Pitches) Gable Detail-6" - PVC, Inverted "T", Arched @ 8' wide (All Pitches) Gable Detail-6" - PVC, Inverted "T", Arched @ 12' wide (All Pitches) * Standard gable program designed to be cut to fit on-site if required
Gable Detail-6" - PVC, Inverted "T" & "V" @ 6' wide with ball (All Pitches) Gable Detail-6" - PVC, Inverted "T" & "V" @ 8' wide with ball (All Pitches) Gable Detail-6" - PVC, Inverted "T" & "V" @ 12' wide with ball (All Pitches) * Standard gable program designed to be cut to fit on-site if required
Gable Detail-6" - PVC, Inverted "T" & "V" @ 6' wide (All Pitches) Gable Detail-6" - PVC, Inverted "T" & "V" @ 8' wide (All Pitches) Gable Detail-6" - PVC, Inverted "T" & "V" @ 12' wide (All Pitches) * Standard gable program designed to be cut to fit on-site if required
Gable Detail-6" - PVC, Inverted "T" & "V", Arched @ 6' wide with ball (All Pitches) Gable Detail-6" - PVC, Inverted "T" & "V", Arched @ 8' wide with ball (All Pitches) Gable Detail-6" - PVC, Inverted "T" & "V", Arched, @ 12' wide with ball (All Pitches) * Standard gable program designed to be cut to fit on-site if required
Gable Detail-6" - PVC, Inverted "T" & "V", Arched @ 6' wide (All Pitches) Gable Detail-6" - PVC, Inverted "T" & "V", Arched @ 8' wide (All Pitches) Gable Detail-6" - PVC, Inverted "T" & "V", Arched @ 12' wide (All Pitches) * Standard gable program designed to be cut to fit on-site if required

FORMAT	
1" POST (G1)	2 1/2" POST (G3)
\$ 151.89	\$ 199.22
\$ 188.03	\$ 262.28
\$ 260.31	\$ 388.39
\$ 109.09	\$ 156.42
\$ 145.23	\$ 219.48
\$ 217.52	\$ 345.59
\$ 194.04	\$ 286.76
\$ 232.98	\$ 325.71
\$ 310.89	\$ 403.61
\$ 161.80	\$ 243.96
\$ 197.67	\$ 282.91
\$ 267.11	\$ 360.81
\$ 198.40	\$ 320.21
\$ 221.06	\$ 342.87
\$ 266.38	\$ 388.19
\$ 155.60	\$ 277.41
\$ 178.26	\$ 300.08
\$ 223.58	\$ 345.39
\$ 253.81	\$ 366.94
\$ 266.26	\$ 379.39
\$ 291.15	\$ 404.27
\$ 211.01	\$ 324.14
\$ 223.46	\$ 336.59
\$ 248.35	\$ 361.47

**PRICES SUBJECT TO CHANGE WITHOUT NOTICE

PRESTIGE 4" IC GABLES - 2018





PRESTIGE GABLES

G1

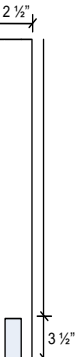

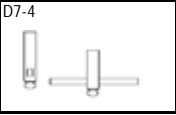
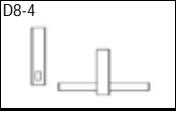
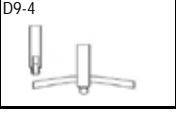
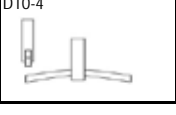
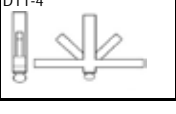
G3

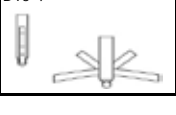

INVERTED "C" GABLES	PRODUCT CODE		DESCRIPTION	FORMAT	
	G1	G3		1" POST (G1)	2 1/2" POST (G3)
	G1ICB414-72	G3ICB42.54-72	*Roof Pitch Must be Supplied for Manufacturing Gable Detail-4" - PVC, Inverted "C" @ 6' wide with ball (All Pitches) Gable Detail-4" - PVC, Inverted "C" @ 8' wide with ball (All Pitches) Gable Detail-4" - PVC, Inverted "C" @ 12' wide with ball (All Pitches) * Standard gable program designed to be cut to fit on-site if required	\$ 128.72	\$ 168.83
	G1ICB414-96	G3ICB42.54-96		\$ 159.34	\$ 222.27
	G1ICB414-144	G3ICB42.54-144		\$ 220.61	\$ 329.14
	G1IC414-72	G3IC42.54-72	Gable Detail-4" - PVC, Inverted "C" @ 6' wide (All Pitches) Gable Detail-4" - PVC, Inverted "C", @ 8' wide (All Pitches) Gable Detail-4" - PVC, Inverted "C" @ 12' wide (All Pitches) * Standard gable program designed to be cut to fit on-site if required	\$ 92.45	\$ 132.56
	G1IC414-96	G3IC42.54-96		\$ 123.07	\$ 186.00
	G1IC414-144	G3IC42.54-144		\$ 184.34	\$ 292.87
	G1ICAB414-72	G3ICAB42.54-72	Gable Detail-4" - PVC, Inverted "C", Arched @ 6' wide with ball (All Pitches) Gable Detail-4" - PVC, Inverted "C", Arched @ 8' wide with ball (All Pitches) Gable Detail-4" - PVC, Inverted "C", Arched, @ 12' wide with ball (All Pitches) * Standard gable program designed to be cut to fit on-site if required	\$ 164.44	\$ 243.01
	G1ICAB414-96	G3ICAB42.54-96		\$ 197.44	\$ 276.03
	G1ICAB414-144	G3ICAB42.54-144		\$ 263.47	\$ 342.04
	G1ICA414-72	G3ICA42.54-72	Gable Detail-4" - PVC, Inverted "C", Arched @ 6' wide (All Pitches) Gable Detail-4" - PVC, Inverted "C", Arched @ 8' wide (All Pitches) Gable Detail-4" - PVC, Inverted "C", Arched @ 12' wide (All Pitches) * Standard gable program designed to be cut to fit on-site if required	\$ 137.11	\$ 206.74
	G1ICA414-96	G3ICA42.54-96		\$ 167.52	\$ 239.76
	G1ICA414-144	G3ICA42.54-144		\$ 226.36	\$ 305.77
	G1ICVB414-72	G3ICVB42.54-72	Gable Detail-4" - PVC, Inverted "C" & "V" @ 6' wide with ball (All Pitches) Gable Detail-4" - PVC, Inverted "C" & "V" @ 8' wide with ball (All Pitches) Gable Detail-4" - PVC, Inverted "C" & "V" @ 12' wide with ball (All Pitches) * Standard gable program designed to be cut to fit on-site if required	\$ 168.13	\$ 271.37
	G1ICVB414-96	G3ICVB42.54-96		\$ 187.34	\$ 290.57
	G1ICVB414-144	G3ICVB42.54-144		\$ 225.74	\$ 328.98
	G1ICV414-72	G3ICV42.54-72	Gable Detail-4" - PVC, Inverted "C" & "V" @ 6' wide (All Pitches) Gable Detail-4" - PVC, Inverted "C" & "V" @ 8' wide (All Pitches) Gable Detail-4" - PVC, Inverted "C" & "V" @ 12' wide (All Pitches) * Standard gable program designed to be cut to fit on-site if required	\$ 131.86	\$ 235.10
	G1ICV414-96	G3ICV42.54-96		\$ 151.07	\$ 254.30
	G1ICV414-144	G3ICV42.54-144		\$ 189.47	\$ 292.71
	G1ICVAB414-72	G3ICVAB42.54-72	Gable Detail-4" - PVC, Inverted "C" & "V", Arched @ 6' wide with ball (All Pitches) Gable Detail-4" - PVC, Inverted "C" & "V", Arched @ 8' wide with ball (All Pitches) Gable Detail-4" - PVC, Inverted "C" & "V", Arched, @ 12' wide with ball (All Pitches) * Standard gable program designed to be cut to fit on-site if required	\$ 215.09	\$ 310.97
	G1ICVAB414-96	G3ICVAB42.54-96		\$ 225.64	\$ 321.52
	G1ICVAB414-144	G3ICVAB42.54-144		\$ 246.74	\$ 342.60
	G1ICVA414-72	G3ICVA42.54-72	Gable Detail-4" - PVC, Inverted "C" & "V", Arched @ 6' wide (All Pitches) Gable Detail-4" - PVC, Inverted "C" & "V", Arched @ 8' wide (All Pitches) Gable Detail-4" - PVC, Inverted "C" & "V", Arched @ 12' wide (All Pitches) * Standard gable program designed to be cut to fit on-site if required	\$ 178.82	\$ 274.70
	G1ICVA414-96	G3ICVA42.54-96		\$ 189.37	\$ 285.25
	G1ICVA414-144	G3ICVA42.54-144		\$ 210.47	\$ 306.33

**PRICES SUBJECT TO CHANGE WITHOUT NOTICE



PRESTIGE 6" IC GABLES - 2018



PRESTIGE GABLES	INVERTED "C" GABLES	PRODUCT CODE		DESCRIPTION	FORMAT	
		G1	G3		1" POST (G1)	2 1/2" POST (G3)
						
	D7-6	G11CB616-72 G11CB616-96 G11CB616-144	G31CB62.56-72 G31CB62.56-96 G31CB62.56-144	Gable Detail-6" - PVC, Inverted "C" @ 6' wide with ball (All Pitches) Gable Detail-6" - PVC, Inverted "C" @ 8' wide with ball (All Pitches) Gable Detail-6" - PVC, Inverted "C" @ 12' wide with ball (All Pitches) * Standard gable program designed to be cut to fit on-site if required	\$ 151.89 \$ 188.03 \$ 260.31	\$ 199.22 \$ 262.28 \$ 388.39
	D8-6	G11C616-72 G11C616-96 G11C616-144	G31C62.56-72 G31C62.56-96 G31C62.56-144	Gable Detail-6" - PVC, Inverted "C" @ 6' wide (All Pitches) Gable Detail-6" - PVC, Inverted "C" @ 8' wide (All Pitches) Gable Detail-6" - PVC, Inverted "C" @ 12' wide (All Pitches) * Standard gable program designed to be cut to fit on-site if required	\$ 109.09 \$ 145.23 \$ 217.52	\$ 156.42 \$ 219.48 \$ 345.59
	D9-6	G11CAB616-72 G11CAB616-96 G11CAB616-144	G31CAB62.56-72 G31CAB62.56-96 G31CAB62.56-144	Gable Detail-6" - PVC, Inverted "C", Arched @ 6' wide with ball (All Pitches) Gable Detail-6" - PVC, Inverted "C", Arched @ 8' wide with ball (All Pitches) Gable Detail-6" - PVC, Inverted "C", Arched @ 12' wide with ball (All Pitches) * Standard gable program designed to be cut to fit on-site if required	\$ 194.04 \$ 232.98 \$ 310.89	\$ 286.76 \$ 325.71 \$ 403.61
	D10-6	G11CA616-72 G11CA616-96 G11CA616-144	G31CA62.56-72 G31CA62.56-96 G31CA62.56-144	Gable Detail-6" - PVC, Inverted "C", Arched @ 6' wide (All Pitches) Gable Detail-6" - PVC, Inverted "C", Arched @ 8' wide (All Pitches) Gable Detail-6" - PVC, Inverted "C", Arched @ 12' wide (All Pitches) * Standard gable program designed to be cut to fit on-site if required	\$ 161.80 \$ 197.67 \$ 267.11	\$ 243.96 \$ 282.91 \$ 360.81
	D11-6	G11CVB616-72 G11CVB616-96 G11CVB616-144	G31CVB62.56-72 G31CVB62.56-96 G31CVB62.56-144	Gable Detail-6" - PVC, Inverted "C" & "V" @ 6' wide with ball (All Pitches) Gable Detail-6" - PVC, Inverted "C" & "V" @ 8' wide with ball (All Pitches) Gable Detail-6" - PVC, Inverted "C" & "V" @ 12' wide with ball (All Pitches) * Standard gable program designed to be cut to fit on-site if required	\$ 198.40 \$ 221.06 \$ 266.38	\$ 320.21 \$ 342.87 \$ 388.19
	D12-6	G11CV616-72 G11CV616-96 G11CV616-144	G31CV62.56-72 G31CV62.56-96 G31CV62.56-144	Gable Detail-6" - PVC, Inverted "C" & "V" @ 6' wide (All Pitches) Gable Detail-6" - PVC, Inverted "C" & "V" @ 8' wide (All Pitches) Gable Detail-6" - PVC, Inverted "C" & "V" @ 12' wide (All Pitches) * Standard gable program designed to be cut to fit on-site if required	\$ 155.60 \$ 178.26 \$ 223.58	\$ 277.41 \$ 300.08 \$ 345.39
	D15-6	G11CVAB616-72 G11CVAB616-96 G11CVAB616-144	G31CVAB62.56-72 G31CVAB62.56-96 G31CVAB62.56-144	Gable Detail-6" - PVC, Inverted "C" & "V", Arched @ 6' wide with ball (All Pitches) Gable Detail-6" - PVC, Inverted "C" & "V", Arched @ 8' wide with ball (All Pitches) Gable Detail-6" - PVC, Inverted "C" & "V", Arched @ 12' wide with ball (All Pitches) * Standard gable program designed to be cut to fit on-site if required	\$ 253.81 \$ 266.26 \$ 291.15	\$ 366.94 \$ 379.39 \$ 404.27
	D16-6	G11CVA616-72 G11CVA616-96 G11CVA616-144	G31CVA62.56-72 G31CVA62.56-96 G31CVA62.56-144	Gable Detail-6" - PVC, Inverted "C" & "V", Arched @ 6' wide (All Pitches) Gable Detail-6" - PVC, Inverted "C" & "V", Arched @ 8' wide (All Pitches) Gable Detail-6" - PVC, Inverted "C" & "V", Arched @ 12' wide (All Pitches) * Standard gable program designed to be cut to fit on-site if required	\$ 211.01 \$ 223.46 \$ 248.35	\$ 324.14 \$ 336.59 \$ 361.47

**PRICES SUBJECT TO CHANGE WITHOUT NOTICE

PRESTIGE GINGERBREADS - 2018

P
R
E
S
T
I
G
E

G
I
N
G
E
R
B
R
E
A
D
S

PRODUCT CODE	DESCRIPTION	STANDARD PRICE
GDGB-23-07/12-72 GDGB-23-08/12-72 GDGB-23-09/12-72 GDGB-23-10/12-72 GDGB-23-11/12-72 GDGB-23-12/12-72	Gable Gingerbread - 2" P x 7/12 Pitch, 72" Wide Gable Gingerbread - 2" P x 8/12 Pitch, 72" Wide Gable Gingerbread - 2" P x 9/12 Pitch, 72" Wide Gable Gingerbread - 2" P x 10/12 Pitch, 72" Wide Gable Gingerbread - 2" P x 11/12 Pitch, 72" Wide Gable Gingerbread - 2" P x 12/12 Pitch, 72" Wide	\$ 266.18 \$ 287.47 \$ 310.45 \$ 335.30 \$ 362.12 \$ 391.09
GCGB101-667 GCGB101-865 GCGB101-1063 GCGB101-1272	Gable Detail - PVC - Gingerbread - Scroll 1, 1" P x 6/12 - 72" Wide Gable Detail - PVC - Gingerbread - Scroll 1, 1" P x 8/12 - 65" Wide Gable Detail - PVC - Gingerbread - Scroll 1, 1" P x 10/12 - 63" Wide Gable Detail - PVC - Gingerbread - Scroll 1, 1" P x 12/12 - 72" Wide	\$ 179.54 \$ 194.70 \$ 220.39 \$ 317.00
GDGB102-660 GDGB102-857 GDGB102-1057 GDGB102-1272	Gable Detail - PVC - Gingerbread - Scroll 2, 1" P x 6/12 - 60" Wide Gable Detail - PVC - Gingerbread - Scroll 2, 1" P x 8/12 - 57" Wide Gable Detail - PVC - Gingerbread - Scroll 2, 1" P x 10/12 - 57" Wide Gable Detail - PVC - Gingerbread - Scroll 2, 1" P x 12/12 - 72" Wide	\$ 205.86 \$ 215.58 \$ 248.64 \$ 333.73
GDGB103-665 GDGB103-860 GDGB103-1058 GDGB103-1272	Gable Detail - PVC - Gingerbread - Scallop /w Scroll, 1" P x 6/12 - 65 Gable Detail - PVC - Gingerbread - Scallop /w Scroll, 1" P x 8/12 - 60 Gable Detail - PVC - Gingerbread - Scallop /w Scroll, 1" P x 10/12 - 58 Gable Detail - PVC - Gingerbread - Scallop /w Scroll, 1" P x 12/12 - 72	\$ 230.00 \$ 256.05 \$ 273.69 \$ 383.92
GDGB104-660 GDGB104-857 GDGB104-1054 GDGB104-1272	Gable Detail - PVC - Gingerbread - Medallion 1, 1" P x 6/12 - 60 Gable Detail - PVC - Gingerbread - Medallion 1, 1" P x 8/12 - 57 Gable Detail - PVC - Gingerbread - Medallion 1, 1" P x 10/12 - 54 Gable Detail - PVC - Gingerbread - Medallion 1, 1" P x 12/12 - 72	\$ 194.97 \$ 198.85 \$ 201.28 \$ 317.00
GDGB105-664 GDGB105-860 GDGB105-1058 GDGB105-1272	Gable Detail - PVC - Gingerbread - Scroll 3, 1" P x 6/12 - 64" Wide Gable Detail - PVC - Gingerbread - Scroll 3, 1" P x 8/12 - 60" Wide Gable Detail - PVC - Gingerbread - Scroll 3, 1" P x 10/12 - 58" Wide Gable Detail - PVC - Gingerbread - Scroll 3, 1" P x 12/12 - 72" Wide	\$ 185.03 \$ 207.28 \$ 229.55 \$ 333.73
GDGB106-667 GDGB106-864 GDGB106-1061 GDGB106-1272	Gable Detail - PVC - Gingerbread - Owl Scroll, 1" P x 6/12 - 67" Wide Gable Detail - PVC - Gingerbread - Owl Scroll, 1" P x 8/12 - 64" Wide Gable Detail - PVC - Gingerbread - Owl Scroll, 1" P x 10/12 - 61" Wide Gable Detail - PVC - Gingerbread - Owl Scroll, 1" P x 12/12 - 72" Wide	\$ 183.29 \$ 203.08 \$ 219.75 \$ 333.73
GDGB107-662 GDGB107-860 GDGB107-1058 GDGB107-1272	Gable Detail - PVC - Gingerbread - Marine Scroll, 1" P x 6/12 - 62" Wide Gable Detail - PVC - Gingerbread - Marine Scroll, 1" P x 8/12 - 60" Wide Gable Detail - PVC - Gingerbread - Marine Scroll, 1" P x 10/12 - 58" Wide Gable Detail - PVC - Gingerbread - Marine Scroll, 1" P x 12/12 - 72" Wide	\$ 180.85 \$ 200.30 \$ 229.54 \$ 333.73
GDGB108-670 GDGB108-865 GDGB108-1062 GDGB108-1272	Gable Detail - PVC - Gingerbread - Butterfly, 1" P x 6/12 - 70" Wide Gable Detail - PVC - Gingerbread - Butterfly, 1" P x 8/12 - 65" Wide Gable Detail - PVC - Gingerbread - Butterfly, 1" P x 10/12 - 62" Wide Gable Detail - PVC - Gingerbread - Butterfly, 1" P x 12/12 - 72" Wide	\$ 165.52 \$ 176.62 \$ 210.03 \$ 317.00

**PRICES SUBJECT TO CHANGE WITHOUT NOTICE

PRESTIGE PLANTERS - 2018

P
R
E
S
T
I
G
E

P
L
A
N
T
E
R
S

WINDOW BOXES

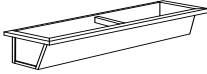

PRODUCT CODE	DESCRIPTION	NATURAL FINISH	PRE-FINISHED
PPW14	Flower -PVC-Window Box - 4'	\$ 110.10	\$ 143.13
PPW15	Flower -PVC-Window Box - 5'	\$ 132.86	\$ 172.72
PPW16	Flower -PVC-Window Box - 6'	\$ 159.32	\$ 207.12
PPW17	Flower -PVC-Window Box - 7'	\$ 185.79	\$ 241.52
PPW18	Flower -PVC-Window Box - 8'	\$ 211.70	\$ 275.21

#1



PPFL-CFMNTP-12	Flower -PVC-Planter Box /w Craftsman Edge Top - 12" x 12" x 12"	\$ 47.30	\$ 61.50
PPFL-CFMNTP-16	Flower -PVC-Planter Box /w Craftsman Edge Top - 16" x 16" x 16"	\$ 90.80	\$ 118.04
PPFL-CFMNTP-18	Flower -PVC-Planter Box /w Craftsman Edge Top - 18" x 18" x 18"	\$ 98.88	\$ 128.55
PPFL-CFMNTP-22	Flower -PVC-Planter Box /w Craftsman Edge Top - 22" x 22" x 22"	\$ 117.89	\$ 153.26
PPFL-CFMNTP-28	Flower -PVC-Planter Box /w Craftsman Edge Top - 28" x 28" x 28"	\$ 172.87	\$ 224.73

#2



PPFL-SHNGCB-18	Flower -PVC-Planter Box /w Shingle Cap & Base - 18" x 18" x 18"	\$ 127.61	\$ 165.90
PPFL-SHNGCB-22	Flower -PVC-Planter Box /w Shingle Cap & Base - 22" x 22" x 22"	\$ 162.14	\$ 210.79
PPFL-SHNGCB-28	Flower -PVC-Planter Box /w Shingle Cap & Base - 28" x 28" x 28"	\$ 257.49	\$ 334.74
PPFL-SHNGCB-1836	Flower -PVC-Planter Box /w Shingle Cap & Base - 18" x 18" x 36"	\$ 216.45	\$ 281.39
PPFL-SHNGCB-1848	Flower -PVC-Planter Box /w Shingle Cap & Base - 18" x 18" x 48"	\$ 265.83	\$ 345.58
PPFL-SHNGCB-1860	Flower -PVC-Planter Box /w Shingle Cap & Base - 18" x 18" x 60"	\$ 309.08	\$ 401.81

#3



PPFL-RSSHNG-18	Flower -PVC- Recessed Square Edge Planter Box /w Shingle Mould Cap/w Trim & Base - 18" x 18" x 18"	\$ 172.79	\$ 224.63
PPFL-RSSHNG-22	Flower -PVC- Recessed Square Edge Planter Box /w Shingle Mould Cap/w Trim & Base - 22" x 22" x 22"	\$ 211.98	\$ 275.57
PPFL-RSSHNG-2236	Flower -PVC- Recessed Square Edge Planter Box /w Shingle Mould Cap/w Trim & Base - 22" x 22" x 36"	\$ 304.62	\$ 396.01
PPFL-RSSHNG-2248	Flower -PVC- Recessed Square Edge Planter Box /w Shingle Mould Cap/w Trim & Base - 22" x 22" x 48"	\$ 361.53	\$ 469.99
PPFL-RSSHNG-2260	Flower -PVC- Recessed Square Edge Planter Box /w Shingle Mould Cap/w Trim & Base - 22" x 22" x 60"	\$ 416.87	\$ 541.94

#4



PPFL-RSX-18	Flower -PVC- Planter Box /w Applied "X" - 18" x 18" x 18"	\$ 187.59	\$ 243.86
PPFL-RSX-22	Flower -PVC- Planter Box /w Applied "X" - 22" x 22" x 22"	\$ 232.32	\$ 302.01
PPFL-RSX-2236	Flower -PVC- Planter Box /w Applied "X" - 22" x 22" x 36"	\$ 318.25	\$ 413.72
PPFL-RSX-2248	Flower -PVC- Planter Box /w Applied "X" - 22" x 22" x 48"	\$ 391.92	\$ 509.50
PPFL-RSX-2260	Flower -PVC- Planter Box /w Applied "X" - 22" x 22" x 60"	\$ 465.58	\$ 605.25

PLAIN PLANTERS



PPF1BD	Planter-PVC-Floor-Plain Panel - 12"W x 17"H	\$ 67.55	\$ 87.82
PPF1AE	Planter-PVC-Floor-Plain Panel - 11"W x 19"H	\$ 67.04	\$ 87.16

RAISED PANEL PLANTERS

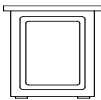

PPF3BD	Planter-PVC-Floor-Raised Panel - 12"W x 17"H	\$ 87.12	\$ 113.26
PPF3AE	Planter-PVC-Floor-Raised Panel - 11"W x 19"H	\$ 86.64	\$ 112.64

PLANTER STANDS

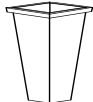

PPS913(42)	Planter-PVC-Stand - 9" - 13" x 42" Tapered	\$ 187.31	\$ 243.50
PPS913(60)	Planter-PVC-Stand - 9" - 13" x 60" Tapered	\$ 235.13	\$ 305.67
PPST	PVC Cocktail Table Square Top - 1/2" x 18 3/4" x 18 3/4"	\$ 31.60	\$ 41.09
PPSO	PVC Cocktail Table Oval Top - 1/2" x 23" x 35"	\$ 46.76	\$ 60.79
PPSR	PVC Cocktail Table Round Top - 1/2" x 23" x 35"	\$ 31.60	\$ 41.09

**PRICES SUBJECT TO CHANGE WITHOUT NOTICE

PRESTIGE CORNICE - 2018

P
R
E
S
T
I
G
E

C
O
R
N
I
C
E

	PRODUCT CODE	DESCRIPTION	NATURAL FINISH	PRE-FINISHED
12' PRESTIGE CORNICE	FB-PSCB-58(0612)	Cornice - PVC, Solid Crown/Base Cap, 5/8" x 6" x 12'	\$ 78.17	\$ 97.71
	FB-PSCB-58(0812)	Cornice - PVC, Solid Crown/Base Cap, 5/8" x 8" x 12'	\$ 104.20	\$ 130.26
	FB-PSCB-58(1012)	Cornice - PVC, Solid Crown/Base Cap, 5/8" x 10" x 12'	\$ 117.54	\$ 146.93
	FB-PSCB-58(1212)	Cornice - PVC, Solid Crown/Base Cap, 5/8" x 12" x 12.	\$ 130.97	\$ 163.71
	FB-C-38(2.512)	Cornice - PVC, Top Cap, 3/8" x 2 1/2" x 12'	\$ 11.53	\$ 14.41
16' PRESTIGE CORNICE	FB-PSCB-58(0616)	Cornice - PVC, Solid Crown/Base Cap, 5/8" x 6" x 16'	\$ 104.21	\$ 130.27
	FB-PSCB-58(0816)	Cornice - PVC, Solid Crown/Base Cap, 5/8" x 8" x 16'	\$ 138.94	\$ 173.67
	FB-PSCB-58(1016)	Cornice - PVC, Solid Crown/Base Cap, 5/8" x 10" x 16'	\$ 156.72	\$ 195.90
	FB-PSCB-58(1216)	Cornice - PVC, Solid Crown/Base Cap, 5/8" x 12" x 16'	\$ 174.62	\$ 218.28
	FB-C-38(2.516)	Cornice - PVC, Top Cap, 3/8" x 2 1/2" x 16'	\$ 15.37	\$ 19.21
4' PRESTIGE "EASY FIT" CORNICE	FB-PSCB(e)-58(0604)	Cornice "Easy Fit" - PVC, Solid Crown/Base Cap, 5/8" x 6" x 4'	\$ 31.26	\$ 39.08
	FB-PSCB(e)-58(0804)	Cornice "Easy Fit" - PVC, Solid Crown/Base Cap, 5/8" x 8" x 4'	\$ 41.68	\$ 52.10
	FB-PSCB(e)-58(1004)	Cornice "Easy Fit" - PVC, Solid Crown/Base Cap, 5/8" x 10" x 4'	\$ 47.02	\$ 58.77
	FB-PSCB(e)-58(1204)	Cornice "Easy Fit" - PVC, Solid Crown/Base Cap, 5/8" x 12" x 4'	\$ 52.39	\$ 65.48
	FB-C-38(2.504)	Decor Cornice - PVC, Top Cap, 3/8" x 2 1/2" x 4'	\$ 4.61	\$ 5.77
8' PRESTIGE "EASY FIT" CORNICE	FB-PSCB-58(0608)	Cornice - PVC, Solid Crown/Base Cap, 5/8" x 6" x 8'	\$ 62.53	\$ 78.17
	FB-PSCB(e)-58(0808)	Cornice "Easy Fit" - PVC, Solid Crown/Base Cap, 5/8" x 8" x 8'	\$ 83.36	\$ 104.20
	FB-PSCB(e)-58(1008)	Cornice "Easy Fit" - PVC, Solid Crown/Base Cap, 5/8" x 10" x 8'	\$ 94.04	\$ 117.54
	FB-PSCB(e)-58(1208)	Cornice "Easy Fit" - PVC, Solid Crown/Base Cap, 5/8" x 12" x 8'	\$ 104.78	\$ 130.97
	FB-C-38(2.508)	Decor Cornice - PVC, Top Cap, 3/8" x 2 1/2" x 8'	\$ 9.22	\$ 11.53

****PRICES SUBJECT TO CHANGE WITHOUT NOTICE**

PRESTIGE BRACKETS - 2018

P
R
E
S
T
I
G
E

B
R
A
C
K
E
T
S



PRODUCT CODE
GBP-2411-1 GBP-2411-2

DESCRIPTION
PVC - Bracket - 16\"/>

STANDARD PACKAGE
\$ 73.39
\$ 75.06



GBP-2480-1 GBP-2480-2

PVC - Bracket - 23 1/2\"/>

\$ 83.57
\$ 85.27



GBP-2520

PVC - Bracket - 39\"/>

\$ 152.30



GBP-2558-1 GBP-2558-2 GBP-2558-3
--

PVC - Bracket - 13\"/>

\$ 81.82
\$ 96.68
\$ 145.01
\$ -



GBP-2567-1 GBP-2567-2 GBP-2567-1-S GBP-2567-2-S
--

PVC - Bracket - 32\"/>

\$ 236.29
\$ 195.62
\$ 329.89
\$ 289.22



GBP-2588 GBP-2588-2 GBP-2588-3

PVC - Bracket - 9\"/>

\$ 35.93
\$ 167.26
\$ 278.77



GBP-2614-1 GBP-2614-2

PVC - Bracket - 18\"/>

\$ 89.56
\$ 126.93



GBP-2701

PVC - Bracket - 22\"/>

\$ 84.86
\$ 190.95
\$ 99.72



GBP-2832

PVC - Bracket - 60\"/>

\$ 198.75



GBP-2948-1 GBP-2948-2 GBP-2948-1-S GBP-2948-2-S GBP-2948-3-S
--

PVC - Bracket - 40\"/>

\$ 236.29
\$ 195.62
\$ 329.89
\$ 289.22
\$ 461.18

P R E S T I G E
B R A C K E T S



GBP-5400
GBP-5410

Bracket-PVC, Stepped Bracket /w Covered Steps & Full Round Detail 12 1/4"P x 27 1/4"H x 5"W
Bracket-PVC, Stepped Bracket /w Covered Steps & Full Round Detail 42"P x 63"H x 7 1/4"W

\$ 235.91
\$ 589.78



GBP-5500

Bracket-PVC, Porch Bracket /w Scroll Detail 12"P x 12"H x 1 1/2"W

\$ 51.49



GBP-5600
GBP-5610
GBP-5620

PVC - Bracket - 14"P x 14"H x 4"W
PVC - Bracket - 20"P x 20"H x 4"W
PVC - Bracket - 24"P x 24"H x 5 1/2"W

\$ 65.86
\$ 78.13
\$ 85.78



GBP-2650
GBP-2650-2
GBP-2650-3
GBP-2650-4

Bracket - PVC, 21"P x 24"H x 6"W- Top Closed
Bracket - PVC, 24"P x 24"H x 6"W- Top Closed
Bracket - PVC, 12"P x 24"H x 6"W- Top Closed
Bracket - PVC, 12"P x 12"H x 6"W- Top Closed

\$ 151.72
\$ 180.34
\$ 67.91
\$ 40.56



GBP-5800
GBP-5800-2

PVC - Bracket - 13 1/2"P x 13 1/2"H x 3"W
PVC - Bracket - 28"P x 28"H x 3"W

\$ 79.04
\$ 163.93



GBP-5900

PVC - Bracket - 19"P x 31"H x 4"W

\$ 155.51



GBP-6000
GBP-6000-2

PVC - Bracket - 15"P x 15"H x 6"W
PVC - Bracket - 6"P x 6"H x 3"W

\$ 60.48
\$ 26.88



GBP-6100

PVC - Bracket - 14"P x 14"H x 4"W

\$ 68.04



GBP-6200

PVC - Bracket - 14"P x 22"W x 4"W

\$ 79.11



GBP-6300

PVC - Bracket - 11 1/2"P x 11 1/2"H x 3"W

\$ 67.72



GBP-6400

PVC - Bracket - 15 1/2"P x 15 1/2"H x 5 1/4"W

\$ 73.89

**PRICES SUBJECT TO CHANGE WITHOUT NOTICE

PRESTIGE SCREENS - 2018

P
R
E
S
T
I
G
E

S
C
R
E
E
N
S

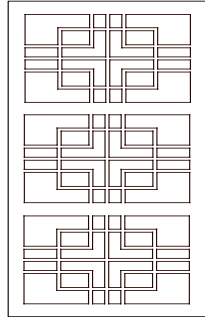

PRODUCT CODE

SCRN-1A-4496(X)
SCRN-1B-4448(X)
SCRN-1C-4424(X)

DESCRIPTION

PVC, Screen 1 - 44"W x 96"H
PVC, Screen 1 - 44"W x 48"H
PVC, Screen 1 - 44"W x 24"H

<u>3/4" MATERIAL</u> <u>(3)</u>	<u>4/4" MATERIAL</u> <u>(4)</u>
------------------------------------	------------------------------------

\$ 304.33	\$ 369.20
\$ 148.26	\$ 180.69
\$ 76.10	\$ 92.32

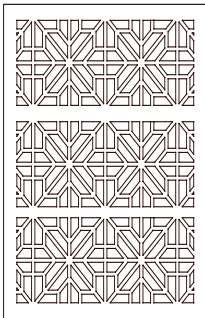

SCRN-2A-4496(X)
SCRN-2B-4448(X)
SCRN-2C-4424(X)

PVC, Screen 2 - 44"W x 96"H
PVC, Screen 2 - 44"W x 48"H
PVC, Screen 2 - 44"W x 24"H

\$ 347.33	\$ 412.19
\$ 167.80	\$ 200.24
\$ 81.95	\$ 98.17

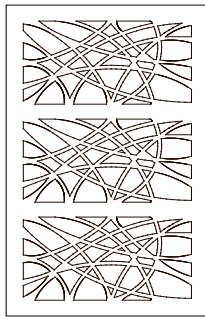

SCRN-3A-4496(X)
SCRN-3B-4448(X)
SCRN-3C-4424(X)

PVC, Screen 3 - 44"W x 96"H
PVC, Screen 3 - 44"W x 48"H
PVC, Screen 3 - 44"W x 34"H

\$ 331.69	\$ 396.56
\$ 163.90	\$ 196.33
\$ 80.00	\$ 96.22

****PRICES SUBJECT TO CHANGE WITHOUT NOTICE**