

G3 Gables with
install track

Prestige **diy**
PRODUCTS

Innovative PVC Systems



Gables & Gingerbread



STAND OUT WITH PRESTIGE DIY PRODUCTS™

Available in a variety of styles Prestige Gables™ accent any home with character and charm. Whether the solution is a desire to achieve a faux wood look to last a lifetime or a complex craftsmanship solution built in traditional style, Prestige Gables™ are engineered to last! Gables are sized from G1 for a simple look to G6 for a larger timber frame look.

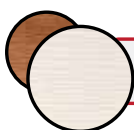
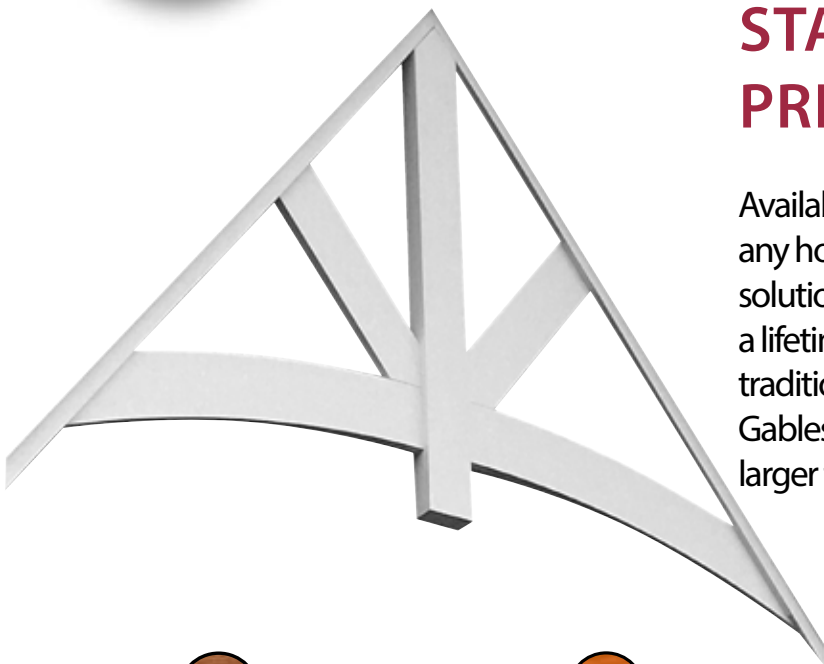

Available in:
WOODGRAIN

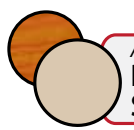

Available:
PAINT AND STAIN FINISHES



Innovative PVC Systems

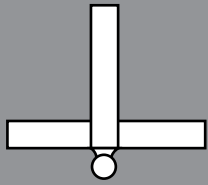

D - 1
(iT-b)

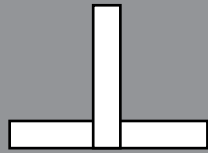

D - 2
(iT)

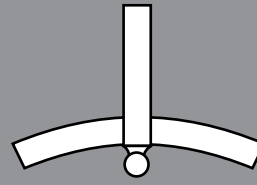

D - 3
(iTa-b)

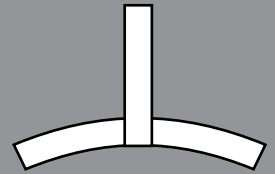

D - 4
(iTa)

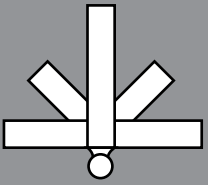

D - 5
(iTv-b)

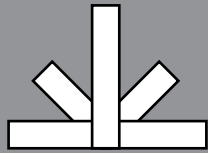

D - 6
(iTv)

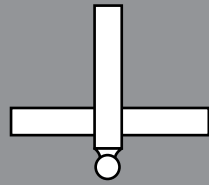

D - 7
(iC-b)

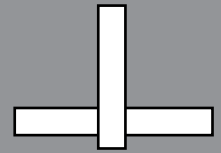

D - 8
(iC)

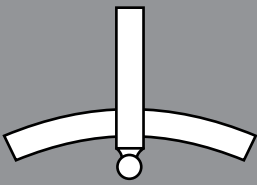

D - 9
(iCa-b)

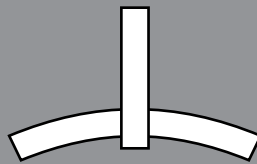

D - 10
(iCa)

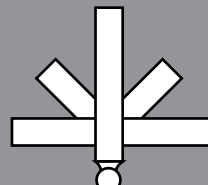

D - 11
(iCv-b)

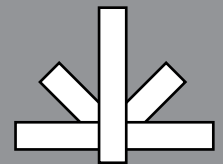

D - 12
(iCv)

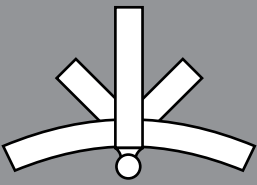

D - 13
(iTVa-b)

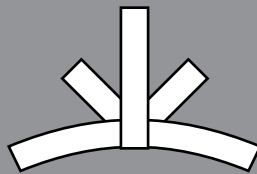

D - 14
(iTVa)

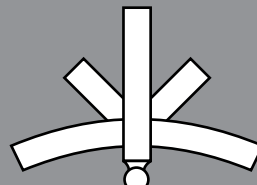

D - 15
(iCVa-b)

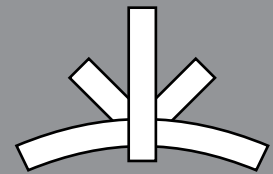

D - 16
(iCVa)

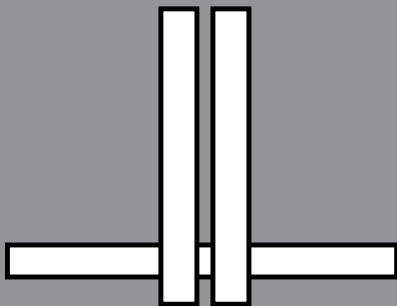

D - 48
(iCd)

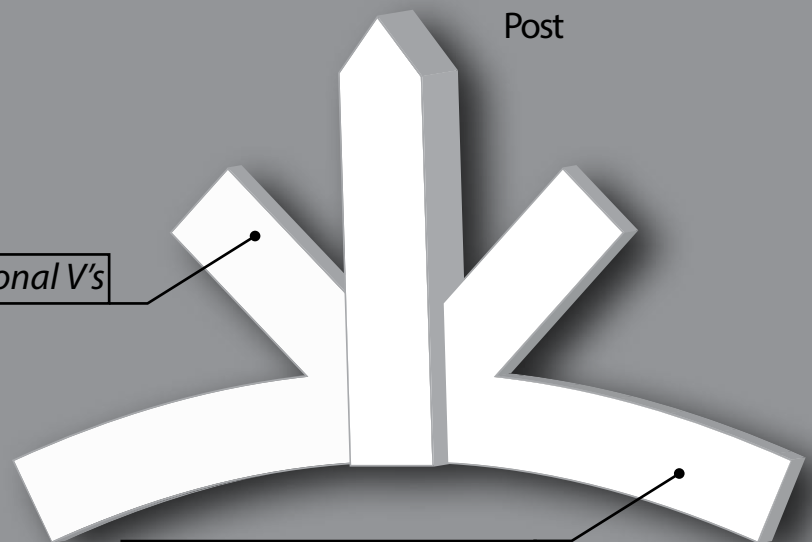

Gable Configurations

The Options: G1 to G6

Understanding your Prestige Gable Detail product code.

G1 Product Codes

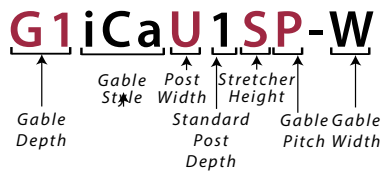

G3, G4 & G6 Product Codes

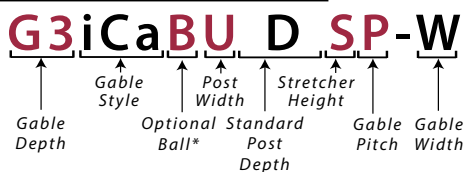

Post Width Options

Note: On standard Gables, post width and stretcher height are the same

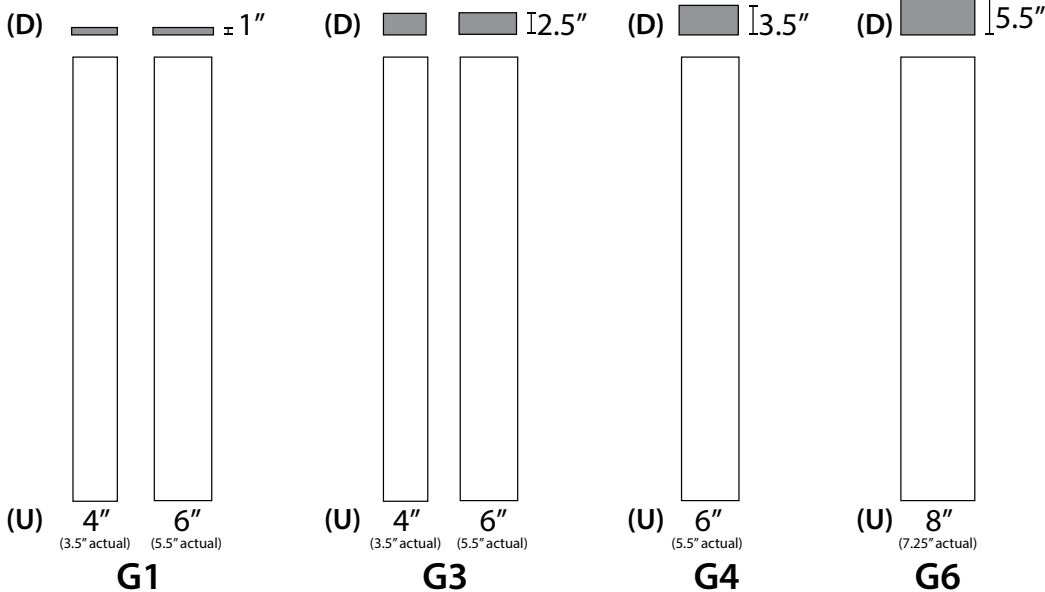

Gable Side View

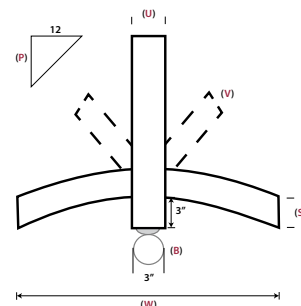
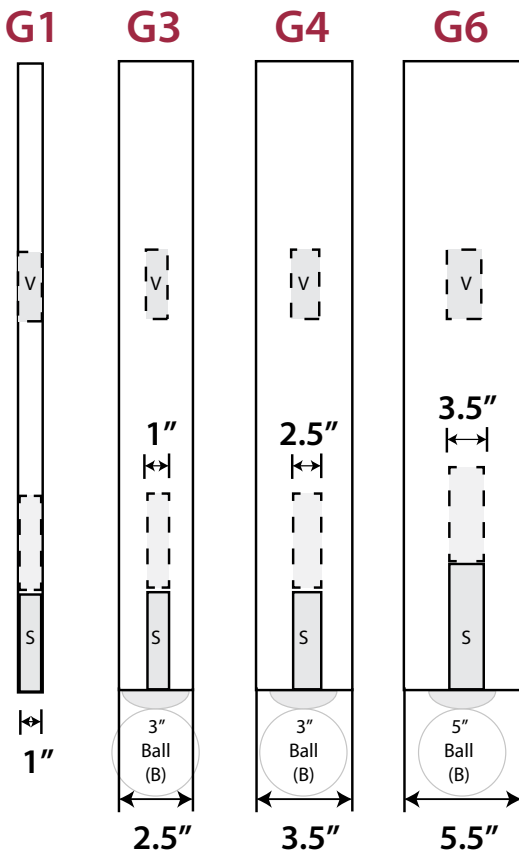

ICa

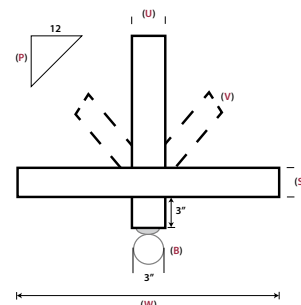

IC

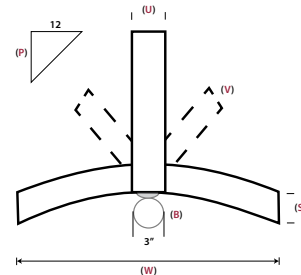

ITa

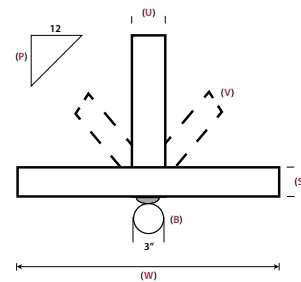

IT

GABLE SPECIFICATIONS



Custom Gingerbread

Prestige **diy**
PRODUCTS

Innovative PVC Systems

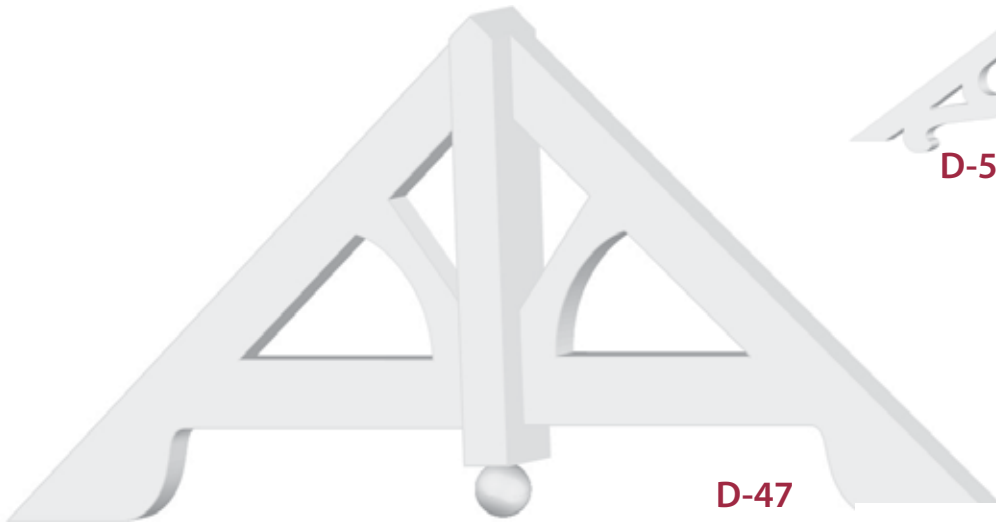

D-47



D-57



D-58



D-59



D-60



D-62



D-61



D-65



D-63



D-64

Custom matching of existing
gingerbreads available.
(See picture opposite)



Innovative PVC Systems

GINGERBREADS

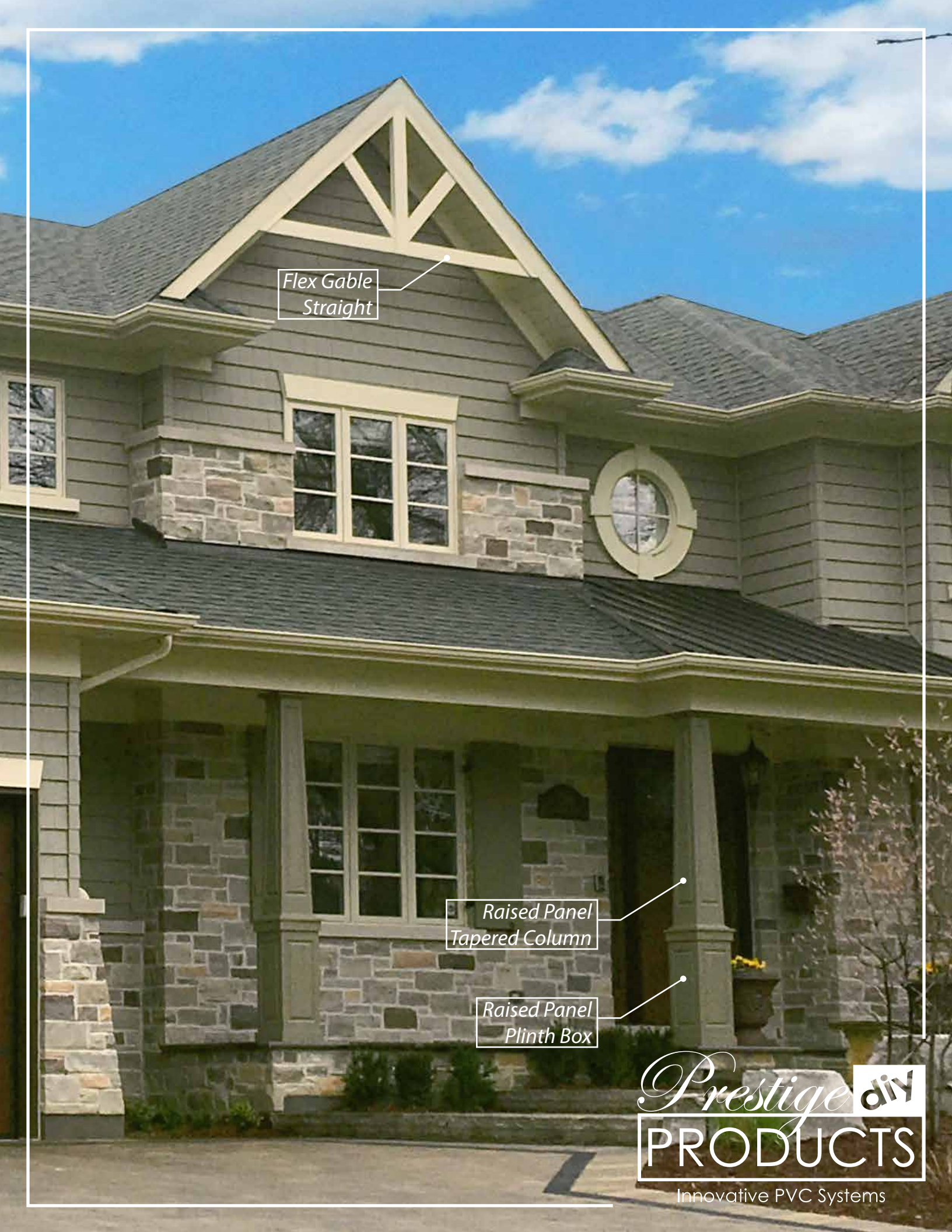

Flex Gable
Straight

Raised Panel
Tapered Column

Raised Panel
Plinth Box

Prestige **diy**
PRODUCTS

Innovative PVC Systems



FLEX Gables

iT configuration with optional "V"

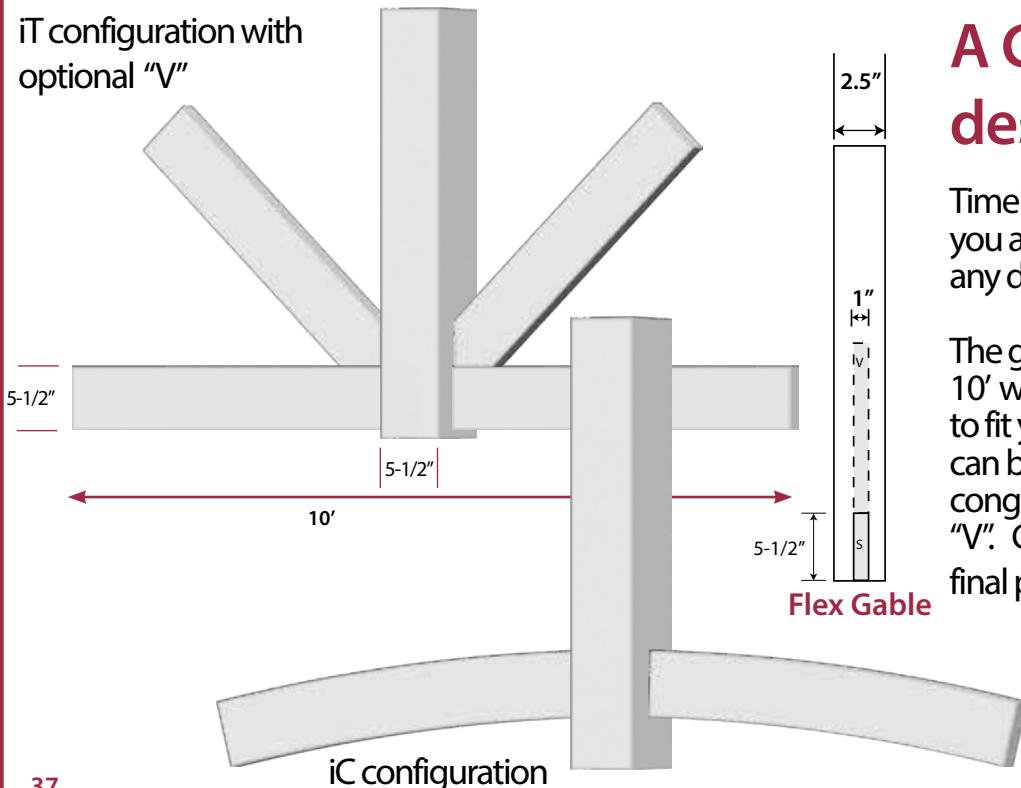

A Gable to fit any design.

Timeless and flexible, FLEX Gables™ offer you a multitude of configurations to suit any design.

The gables have a maximum width of 10' which can be trimmed down onsite to fit your design. Additionally they can be assembled in either the iT or iC configuration with or without optional "V". Giving you 8 different options for the final product.

